

A complete range for metering,
monitoring & power quality

2019
2020



When energy matters



Contents

Integrated technologies	p. 12
Selection guide measurement and monitoring system for electrical installations AC	p. 14
Selection guide measurement and monitoring system for electrical installations DC	p. 20
Selection guide multifunction meters	p. 24
Selection guide software solutions	p. 28

Multi-circuit metering & measurement

DIRIS Digiware AC



DIRIS Digiware D and C
p. 30



DIRIS Digiware U
p. 36



DIRIS Digiware S
p. 38



DIRIS Digiware I
p. 42

DIRIS Digiware DC



DIRIS Digiware Udc
p. 54



DIRIS Digiware Idc
p. 58



DIRIS Digiware IO
p. 66

Single-circuit metering, measurement & analysis



MULTIS L50
p. 72



DIRIS A
p. 76



COUNTIS E
p. 112

Communication interfaces



DIRIS G
p. 146



DATALOG H60/H80
p. 150

Software suite

Embedded web server
WEBVIEW



p. 156

Online energy management
service **N'VIEW**



p. 158

Management software for
COUNTIS and **DIRIS**

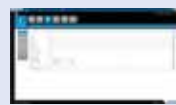

p. 160

Current sensors



**AC current sensors
TE, TR, TF**
p. 46



DC current sensors
p. 62

Current transformers



**Current transformers
5 to 6000 A**
p. 126

Quality analyser



DIRIS Q800
p. 68

Measurement & wireless metering



DIRIS B
p. 104

Ensuring the energy performance of electrical installations, wherever it is critical.

When **energy** matters



Since its foundation more than 95 years ago, SOCOMEC continues to design and manufacture its core products in Europe. Notably solutions for its primary mission: the availability, control and safety of low voltage electrical networks.

As an independent manufacturer, the Group is committed to constant

innovation to improve the energy performance of electrical installations in infrastructures as well as industrial and commercial sites.

Throughout its history, SOCOMEC has constantly anticipated market changes by developing cutting-edge technologies, providing solutions that are adapted to

customer requirements and fully in keeping with international standards.

“Optimising the performance of your system throughout its life cycle” - this is the commitment carried out every day by the SOCOMEC teams around the world, wherever your business is located.

SDW514 B

1
independent
manufacturer

3,500 m²
of test platforms

One of the leading
independent power
testing labs in Europe

10%
of turnover
invested
in R&D

Always at the
cutting-edge of
technology for
innovative, high-
quality products

105,000
on-site
interventions
per year

Nearly 400 experts
in commissioning,
technical audit,
consultancy and
maintenance



Your energy, our expertise

Power conversion

Ensuring the availability and storage of high quality power

With its wide range of continuously evolving products, solutions and services, Socomec are recognised experts in the cutting-edge technologies used for ensuring the highest availability of the electrical power supply to critical facilities and buildings, including:

- static uninterruptible power supplies (UPS) for high-quality power free of distortions

and interruptions occurring on the primary power supply,

- changeover of static, high availability sources for transferring the supply to an operational back-up source,
- permanent monitoring of the electrical facilities to prevent failures and reduce operating losses,
- energy storage for ensuring the proper energy mix of buildings and for stabilisation of the power grid.



© Datarock

Power switching

Managing power and protecting persons and facilities

Active in the industrial switching market since its foundation in 1922, Socomec is today an undisputed leader in the field of low voltage switchgear, providing expert solutions that ensure:

- isolation and on load breaking for the most demanding switching applications,
- continuity of the power supply to electrical facilities via manual remotely operated or automatic transfer switching equipment.
- protection of persons and assets via fuse-based and other specialist solutions.



APPLI 575A

Power monitoring

Managing the energy performance of buildings

Socomec solutions, from current sensors through to a wide choice of innovative scalable software packages are driven by experts in energy performance. They meet the critical requirements of facility managers and operators of commercial, industrial and local authority buildings for:

- measuring energy consumption, identifying sources of excess consumption and raising the awareness of occupants about their impact,
- limiting reactive energy and avoiding the associated tariff penalties,
- using the best available tariffs, checking utility bills and accurately distributing energy billing among consumer entities,
- monitoring and detecting insulation faults.



APPLI 571A

Expert Services

Enabling available, safe and efficient energy

Socomec is committed to delivering a wide range of value-added services to ensure the reliability and optimisation of end-users' equipment:

- prevention and service operations to lower the risks and enhance the efficiency of operations,
- measurement and analysis of a wide range of electrical parameters leading to

recommendations for improving the site's power quality,

- optimisation of the total cost of ownership and support for a safe transition when migrating from an old to a new generation of equipment,
- consultancy, deployment and training from the project engineering stage through to final procurement,
- performance assessment of the electrical installation throughout the life cycle of the products via analysis of data transmitted by connected devices.



APPLI 760A

Adapted solutions

to meet your energy objectives

SMART BUILDINGS

Reducing your energy bills and energy dependency



DIRIS Digiware AC & DC multi-circuit measurement system



ENERGY MANAGEMENT software packages



AtyS automatic and remotely operated transfer switches



SUNSYS PCS² Power Conversion System and Storage

Controlling and securing your energy



DELPHYS MX UPS



COUNTIS E energy meter and DIRIS A multifunction meter (PMD)

NAVAL SHIPS

Energy conversion in environments with harsh restrictions



SHARYS IP rectifier



NETYS RT-M UPS



UPS and other customised products



SIRCO load break switches

SHOPPING CENTRES

Assuring your business continuity and visitor safety



COUNTIS E energy meter and multi-utility pulse concentrator



AtyS M automatic and remotely operated modular transfer switches



MASTERYS BC+ UPS



EMERGENCY CPSS, secure power supply for emergency systems



ENERGY MANAGEMENT software packages

PUBLIC DISTRIBUTION AND SMART GRID

Helping you to meet the challenge of energy demand and response



SUNSYS PCS² Power Conversion System and Storage



TIPI low-voltage feeder pillar with DIRIS multi-function meter



Auxiliary unit with AtyS transfer switch



SIRCO and SIDER load break switches



DIRIS Digiware AC & DC multi-circuit measurement system

RENEWABLE ENERGY

Guaranteeing the performance, security and durability of your photovoltaic facilities



SUNSYS PCS² Power Conversion System and Storage



INOSYS LBS DC load break switches with tripping function



DIRIS Digiware DC multi-circuit measurement system

HEAVY INDUSTRY



FUSERBLOC fuse combination switches
 Safety enclosure with switch disconnector for standard and explosive environments
 DIRIS Q800 network analyser

POWER PLANTS

Securing the piloting of your high-security installations and installations with seismic constraints

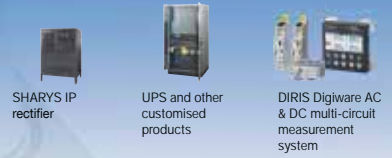

SHARYS IP rectifier
 UPS and other customised products
 DIRIS Digiware AC & DC multi-circuit measurement system

TRANSPORT

Securing the continuity of your installations



ATYS Bypass 'zero outage' solution
 MASTERYS IP+ Rail UPS
 DIRIS A multifunction meter (PMD)

DATA CENTRES

Meeting the challenge of the availability and performance of your energy



Modular and scalable UPS system
 ATYS automatic and remotely operated transfer switches
 DIRIS Digiware AC & DC multi-circuit measurement system
 MASTERYS GP4 UPS
 DIRIS Q800 network analyser

MEDICAL FACILITIES

Assuring patient safety and the energy performance of your hospital



Green Power 2.0 UPS
 ATYS automatic and remotely operated transfer switches
 DIRIS Digiware AC & DC multi-circuit measurement system
 MASTERYS GP4 UPS
 MEDSYS medical IT cabinet

INDUSTRY

Ensuring the competitiveness of your site

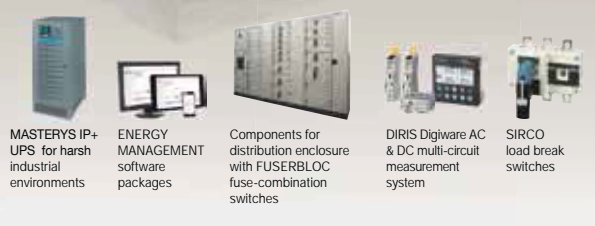

MASTERYS IP+ UPS for harsh industrial environments
 ENERGY MANAGEMENT software packages
 Components for distribution enclosure with FUSERBLOC fuse-combination switches
 DIRIS Digiware AC & DC multi-circuit measurement system
 SIRCO load break switches

EXPERT SERVICES

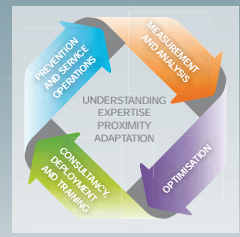

We offer a wide range of value-added services ensuring the reliability of your equipment throughout its design life. Ask for personalised support -

Expert Services your partner

enabling available, safe and efficient energy

SOCOMEK is committed to deliver a wide range of value-added services to ensure the availability of your critical installation, the safety of your site operations and the performance optimisation of your low voltage equipment during its life cycle. The expertise and proximity of our specialists are there to ensure the reliability and durability of your equipment.



APPLI 724 A

Key figures

Nearly 400 Socomec experts supported by 200 engineers and technicians from our distributors, drive the solutions to your specific needs.

Our global presence includes:

- 10 branches in France,
- 12 European subsidiaries,
- 8 Asian subsidiaries,
- representatives in 70+ countries.

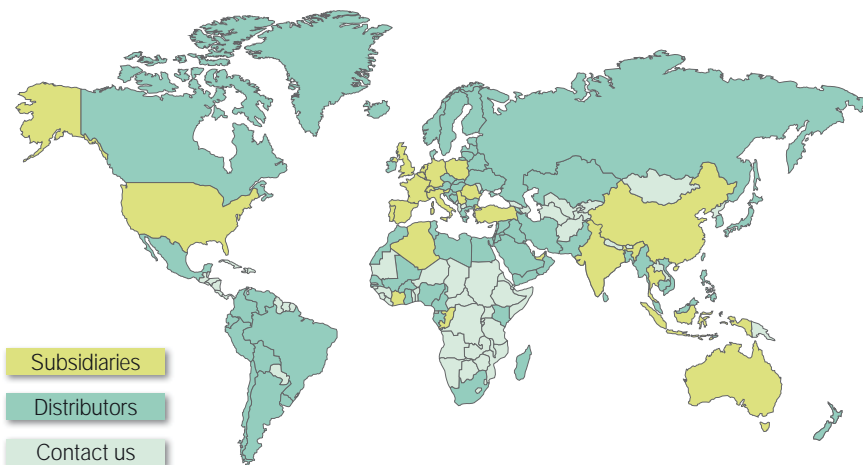

CARTE 063 H

On-site service management

- 65,000 service operations per year (mainly preventive visits).
- 98% Service Level Agreement compliance rate.



APPLI 571 A

Technical hotline network

- 20+ languages spoken.
- 3 advanced technical support centres.
- 100,000+ incoming calls handled per year.



SITE 588 A

Certified expertise

- 5,000 hours of technical training deployed per year (product, methodology and safety).



CORPO 269 A

A cutting-edge laboratory

the backing of an expert

Created in 1965, SOCOMEC's laboratory brings its expertise to guarantee the reliability and the conformity of our products and solutions.

Since 2015, the laboratory renamed Tesla Lab – Power Testing and Certification in 2015, offers its testing and certification services to all its customers.



CORPO 441 A

Proven expertise

Tesla Lab is an independant laboratory specialised in testing of LV switchgear, components and switchgear assemblies.

4 M€ has been invested since 2011 in this 2000 m² laboratory, where 30 experts guarantee the quality of the performed tests, making the Tesla Lab one of the most modern laboratories in Europe.

Vast range of tests

The laboratory has a 100 MVA (I_{cc} 100 kA rms 1 s) short-circuit platform, three 10 kA overload platforms and many other test facilities covering 2000 m² for:

- functional tests,
- mechanical tests: endurance,
- dielectric tests,
- environmental tests: vibration,
- Ingress Protection (IP),
- temperature rise tests up to 60 °C ambient.

International partnership

The laboratory is recognised by the major certification bodies worldwide: member of ASEFA and LOVAG, it is accredited by COFRAC, UL (CTDP), CSA (shared certification) and DEKRA (WMT).

The partnership with many international certification bodies guarantees the quality and safety requirements in each country.

Implementation of standard IEC/EN 61439

Electrical switchgear manufacturers

IEC/EN 61439 standards define the requirements of "Low voltage switchgear assemblies" as well as the tests necessary to ensure the achievement of the specified levels of performance. The compliance with these standards gives a guarantee of safety and performance to the user of the equipment



An original manufacturer according to IEC/EN 61439 standards

Socomec offers a wide range of original manufacturer solutions complying with IEC 61439 standards.

- FLEXYS and CADRYS cabinet systems designed for distribution panel applications.
- Local switching and equipment cabinets covering requirements in power availability and safety.
- Components for integration.

Tesla Lab accredited by COFRAC

With its world-class testing facilities, the Tesla Lab can perform all of the tests required by IEC/EN 61439 standards for switchgear assemblies

We can therefore help you to:

- define a verification program,
- perform conformity tests,
- issue test reports in order to get certification from third party certification bodies (ASEFA, LOVAG, DEKRA, UL, CSA, COFRAC, ASTA...).

Alphabetical index

A	
A cutting-edge laboratory _____	9
Adapted solutions _____	6
C	
Communication accessories _____	154
Contents _____	3
COUNTIS and DIRIS management software tools _____	160
COUNTIS E0x _____	112
COUNTIS E1x _____	114
COUNTIS E2x _____	116
COUNTIS E3x _____	118
COUNTIS E4x _____	120
COUNTIS E5x _____	118
COUNTIS ECix _____	124
Current transformers _____	126
D	
Datalogger _____	150
DC current sensors _____	62
DIRIS A-10 _____	76
DIRIS A-20 _____	84
DIRIS A-30/A-41 _____	88
DIRIS A-40 _____	94
DIRIS A14 _____	80
DIRIS B _____	104
DIRIS Digiware D and C _____	30
DIRIS Digiware I _____	42
DIRIS Digiware Idc _____	58
DIRIS Digiware IO _____	66
DIRIS Digiware S _____	38
DIRIS Digiware U _____	36
DIRIS Digiware Udc _____	54
DIRIS G _____	146
DIRIS Q800 _____	68
E	
Expert Services your partner _____	8

F

For the energy performance of your critical installations _____ 4

I

Integrated technologies _____ 12

M

Measurement shunts _____ 140

MULTIS L50 _____ 72

N

N'VIEW _____ 158

O

Other electrical measurement devices _____ 144

Other products measurement devices _____ 142

S

Selection guide

COUNTIS E _____ 26

DIRIS A _____ 24

DIRIS Digiware AC _____ 14

DIRIS Digiware DC _____ 20

Software solutions _____ 28

T

TE sensors _____ 46

TF sensors _____ 52

TR / iTR sensors _____ 50

W

WEBVIEW _____ 156

Wireless communication interfaces _____ 152



Integrated technologies

Groundbreaking technologies for greater simplicity and performance



PreciSense

Products that are setting new standards in measurement accuracy

The PreciSense technology ensures 100% reliable accuracy across the global measurement chain.

Be guaranteed of the accuracy of your measurements:

- For the global measurement chain.
- For reliable measurements.
- For relevant corrective actions.

PreciSense offers the best accuracy on the market regardless of the type of current sensors used (solid core, split core, flexible or embedded in the DIRIS Digiware S module).



Discover the video

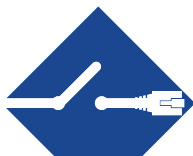

VirtualMonitor

The simple and cost-saving solution for monitoring your protective devices

The VirtualMonitor technology enables an advanced monitoring of protective devices at all levels within the electrical installation.

Virtual Monitor:

- Detects the position and status of the protective device.
- Detects if the breaker has tripped.
- Counts the number of operations and trips.

VirtualMonitor technology monitors the status of protective devices:

- On your entire electrical installation (without additional space).
- Remotely and in real-time.
- Without additional hardware or wiring (without adding auxiliary contacts).



Discover the video



AutoCorrect

Software elimination of wiring errors

The AutoCorrect technology ensures that the measurement is properly wired at all times, thus avoiding on-site interventions.

AutoCorrect ensures the operation of the proper measuring system thanks to simple and rapid detection of wiring errors:

- Automatic wiring control (voltage/current phase association).
- Correction of errors with a single click.
- Feature available off-load.

Error correction's are carried out without any physical modification to the wiring.



Discover the video



PreciSense, VirtualMonitor and AutoCorrect technologies are embedded in Socomec's power monitoring solutions.

Power metering and monitoring system for AC electrical installations

- DIRIS Digiware S with its 3 integrated sensors and DIRIS Digiware I associated with iTR sensors.



Multifunction meters

- DIRIS A-40 with iTR sensors.





Selection guide

Measurement and monitoring system for electrical installations

DIRIS Digiware

Multi-circuit metering & measurement

Build your own AC system

Control and power supply interface (24 VDC)



DIRIS Digiware D
with display

or



DIRIS Digiware C
without screen

Voltage acquisition module



DIRIS Digiware U-x

Current acquisition module with integrated sensors



DIRIS Digiware S

Current acquisition modules



DIRIS Digiware I-3x
3 inputs



DIRIS Digiware I-4x
4 inputs



DIRIS Digiware I-6x
6 inputs

Current sensors



TE
Solid



TR/iTR
Split-core



TF
Flexible

Digital and analogue input/output modules



DIRIS Digiware IO-xx





Find the best DIRIS Digiware configuration!



The Socomec Meter Selector is your digital assistant, helping you find the best DIRIS Digiware configuration for your power monitoring projects, and all in just a few clicks!

- Fill in information regarding your project.
- Download the system diagram and bill of material.
- All your projects are archived in your personal account.

Control and power supply interface

Application	Centralisation and display of data			Data centralisation	Repeater
					
DIRIS Digiware	D-40 <i>p. 30</i>	D-50 <i>p. 30</i>	D-70 <i>p. 30</i>	C-31 <i>p. 30</i>	C-32 <i>p. 30</i>
Function					
Centralising measurement points:	•	•	•	•	•
High-resolution LCD display (configuration, selection and visualisation display of circuits)	•	•	•		
Repeater					•
Power supply					
24 VDC	•	•	•	•	•
Communication					
RS485 Modbus	output	input	input	•	
Bus Digiware	•	•	•	•	•
Ethernet		Modbus TCP BACnet IP SNMP	Modbus TCP BACnet IP SNMP		
Embedded web server			•		

Voltage acquisition module









Application	Metering	Monitoring	Analysis
			
DIRIS Digiware U	U-10 <i>p. 36</i>	U-20 <i>p. 36</i>	U-30 <i>p. 36</i>
Multi-measurement			
U12, U23, U31, V1, V2, V3, f	•	•	•
U system, V system			•
Ph/N unbalance			•
Ph/Ph unbalance			•
Quality analysis			
THDv1, THDv2, THDv3, THDu12, THDu23, THDu31		•	•
Crest factors V1, V2, V3, U12, U23, U31			•
Individual harmonics U & V (up to 63rd)			•
Voltage dips, interruptions and swells (EN50160)			•
Alarms			
On threshold			•
History			
Average values			•
Format			
Width/number of modules	18 mm / 1	18 mm / 1	18 mm / 1

Selection guide



Measurement and monitoring system for electrical installations

DIRIS Digiware

Current acquisition modules

Application	Metering		Monitoring	Analysis	Monitoring	Analysis	Metering	
								
DIRIS Digiware I	I-30 <i>p. 42</i>	I-31 <i>p. 42</i>	I-33 <i>p. 42</i>	I-35 <i>p. 42</i>	I-43 <i>p. 42</i>	I-45 <i>p. 42</i>	I-60 <i>p. 42</i>	I-61 <i>p. 42</i>
Number of current inputs	3	3	3	3	4	4	6	6
Metering								
± kWh, ± kvarh, kVAh	•	•	•	•	•	•	•	•
Load curves		•		•		•		•
Multi-tariff		•		•		•		•
Multi-measurement								
I1, I2, I3, In, ΣP, ΣQ, ΣS, ΣPF	•	•	•	•	•	•	•	•
P, Q, S, PF per phase			•	•	•	•		
Predictive power				•		•		
Current unbalance (Inba, Idir, linv, lhom, Inb)				•		•		
Phi, cos Phi, tan Phi				•		•		
Quality								
THDi1, THDi2, THDi3, THDin			•	•	•	•		
Individual harmonics I (up to 63rd)				•		•		
Crest factors I1, I2, I3, In				•		•		
Overcurrents				•		•		
Alarms								
On threshold				•		•		
Inputs/outputs					2/2	2/2		
History								
Average values				•		•		
Format								
Width/number of modules	18 mm / 1	18 mm / 1	18 mm / 1	18 mm / 1	27 mm / 1.5	27 mm / 1.5	36 mm / 2	36 mm / 2

Current acquisition module with integrated sensors







Application	Metering	Analysis	Monitoring
			
DIRIS Digiware S	S-130 <i>p. 38</i>	S-135 <i>p. 38</i>	S-Datacenter <i>p. 38</i>
Number of current inputs	3	3	3
Basic current I_b	10 A	10 A	10 A
Maximum current I_{max}	63 A	63 A	63 A
Load type accepted	1P + N 2P / 2P + N 3P / 3P + N	1P + N 2P / 2P + N 3P / 3P + N	1P + N
Metering			
± kWh, ± kvarh, kVAh	•	•	•
Multi-tariff (max 8)		•	
Load curves		•	•
Multi-measurement			
I1, I2, I3, In, ΣP, ΣQ, ΣS, ΣPF	•	•	•
P, Q, S, PF per phase		•	•
Predictive power		•	
Current unbalance (Inba, Inb, Idir, linv, lhom)		•	
Phi, cos Phi, tan Phi		•	•
Quality			
THDi1, THDi2, THDi3, THDin		•	•
Individual harmonics I (up to 63rd)		•	
Crest factors U, V, I		•	
K factor		•	
Overcurrents		•	
Alarms			
Thresholds and combinations		•	•
Load level			•
Wiring errors		•	•
Protective device		•	•
Trends			
Average values		•	•
Format			
Width	54 mm	54 mm	54 mm

Selection guide



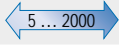
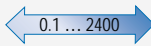

Measurement and monitoring system for electrical installations

DIRIS Digiware



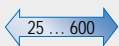
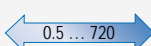

Current sensors

Suitable for new installations match the pitch of protective devices	Solid-core current sensors						
							
	<i>TE-18</i> <i>p. 46</i>	<i>TE-25</i> <i>p. 46</i>	<i>TE-35</i> <i>p. 46</i>	<i>TE-45</i> <i>p. 46</i>	<i>TE-55</i> <i>p. 46</i>	<i>TE-90</i> <i>p. 46</i>	<i>TE-90</i> <i>p. 46</i>
Nominal current I_n (A) 	5 ... 20	25 ... 63	40 ... 160	63 ... 250	160 ... 630	400 ... 1000	600 ... 2000
Real range covered (A) 	0.1 ... 24	0.5 ... 75.6	0.8 ... 192	1.26 ... 300	3.2 ... 756	8 ... 1200	12 ... 2400
Aperture (mm)	Ø 8.4	Ø 8.4	13.5 x 13.5	21 x 21	31 x 31	41 x 41	64 x 64
Dimensions (mm)	28 x 20 x 45	28 x 20 x 45	25 x 32.5 x 65	35 x 32.5 x 71	45 x 32.5 x 86	55 x 32.5 x 100	90 x 126 x 24.6
Connection	RJ12	RJ12	RJ12	RJ12	RJ12	RJ12	RJ12



For demands greater than 2000 A, the 5 A / RJ12 adapter guarantees the compatibility of the TCs.

Suitable for existing installations	Split-core current sensors			
				
	<i>TR/iTR-10</i> <i>p. 50</i>	<i>TR/iTR-14</i> <i>p. 50</i>	<i>TR/iTR-21</i> <i>p. 50</i>	<i>TR/iTR-32</i> <i>p. 50</i>
Nominal current I_n (A) 	25 ... 63	40 ... 160	63 ... 250	160 ... 600
Real range covered (A) 	0.5 ... 90	0.64 ... 120	1.26 ... 200	4 ... 720
Aperture (mm)	Ø 10	Ø 14	Ø 21	Ø 32
Dimensions (mm)	26 x 44 x 28	29 x 67 x 28	37 x 65 x 43	53 x 86 x 47
Connection	RJ12	RJ12	RJ12	RJ12

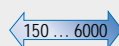
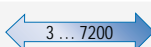
For demands greater than 600 A, the 5 A / RJ12 adapter guarantees the compatibility of the TCs.

Suitable for existing installations with space restrictions or with a high-intensity current	Flexible current sensors				
					
	<i>TF-80</i> <i>p. 52</i>	<i>TF-120</i> <i>p. 52</i>	<i>TF-200</i> <i>p. 52</i>	<i>TF-300</i> <i>p. 52</i>	<i>TF-600</i> <i>p. 52</i>
Nominal current I_n (A) 	150 ... 600	400 ... 2000	600 ... 4000	1600 ... 6000	1600 ... 6000
Real range covered (A) 	3 ... 720	8 ... 2400	12 ... 4800	32 ... 7200	32 ... 7200
Aperture (mm)	Ø 80	Ø 120	Ø 200	Ø 300	Ø 600
Connection	RJ12	RJ12	RJ12	RJ12	RJ12

Input/output modules

Application	Metering / monitoring / control	
		
DIRIS Digiware IO	IO-10 <i>p. 66</i>	IO-20 <i>p. 66</i>
Number of digital inputs/outputs	4/2	
Number of analogue inputs		2
Format		
Width/number of modules	18 mm/1	18 mm/1



Selection guide

Measurement and monitoring system for DC electrical installations

DIRIS Digiware

Multi-circuit metering & measurement

Build your own DC system

Control and power supply interface (24 VDC)



DIRIS Digiware D-x
with display

or



DIRIS Digiware C
without screen

Direct voltage acquisition module



DIRIS Digiware Udc

DC voltage adaptors



DIRIS Digiware
U500dc/U1000dc/U1500dc

DC current acquisition module



DIRIS Digiware Idc
3 current sensor inputs

DC current sensors





Solid-core sensors
50 ... 5000 A



Split-core sensors
50 ... 2000 A

Control and power supply interface



Application	Centralisation and display of data			Data centralisation	Repeater
					
DIRIS Digiware	D-40 <i>p. 30</i>	D-50 <i>p. 30</i>	D-70 <i>p. 30</i>	C-31 <i>p. 30</i>	C-32 <i>p. 30</i>
Function					
Centralising measurement points	•	•	•	•	•
High-resolution LCD display (configuration, selection and visualisation display of circuits)	•	•	•		
Repeater					•
Power supply					
24 VDC	•	•	•	•	•
Communication					
RS485 Modbus	output	input	input	•	
Digiware Bus	•	•	•	•	•
Ethernet		Modbus TCP BACnet IP SNMP	Modbus TCP BACnet IP SNMP		
Embedded web server			•		



Selection guide

Measurement and monitoring system for DC electrical installations



DIRIS Digiware

Direct voltage acquisition module (DC)

Application	DC voltage measurement	
		
DIRIS Digiware Udc	U-31dc <i>p. 54</i>	U-32dc <i>p. 54</i>
Nominal voltage range	24 ... 48 VDC	60 ... 150 VDC
Measuring range (min-max)	19,2 ... 60 VDC	48 ... 180 VDC
Multi-measurement		
DC voltage (VDC)	•	•
Power quality		
V ripple (voltage ripple)	•	•
V _{rms}	•	•
Alarms		
Thresholds and combinations	•	•
Trends		
Average values	•	•
Format		
Width/number of modules	18 mm / 1	

Application	DC voltage adaptors		
			
DIRIS Digiware Udc	U500dc <i>p. 54</i>	U1000dc <i>p. 54</i>	U1500dc <i>p. 54</i>
Max. voltage range	200 ... 600 VDC	400 ... 1200 VDC	1200 ... 1650 VDC
Association			
U-32dc	•	•	•
Format			
Width/number of modules	54 mm / 3		

Direct current acquisition module (DC)

Application	Direct current (DC) measurement modules	
		
DIRIS Digiware Idc	I-30dc <i>p. 58</i>	I-35dc <i>p. 58</i>
Number of current inputs	3	3
Metering		
± kWh	•	•
Load curves		•
Multi-measurement		
DC current (I DC)	•	•
DC power (P DC)	•	•
Predictive power		•
Measurement of current quality		
I ripple (current ripple)		•
I rms		•
Alarms		
Thresholds and combinations		•
Trends		
Average values		•
Format		
Width/number of modules	18 mm / 1	

DC current sensors

TORE_104_A_OPEN_FRONTIERS



TORE_072_A_IPS

DC current sensors measure the load currents of a DC electrical installation and transmit the information to DIRIS Digiware Idc modules via a quick RJ12 connection with color-coded cables for an easy identification of circuits.

The range comprises solid-core and split-core sensors, from 50 to 5000 A in various sizes, suitable for new or retrofit applications.

- Easy connection to prevent wiring errors.
- Up to 3 sensors on each DIRIS Digiware Idc measurement module.



Selection guide

Multifunction meters



DIRIS A

Single-circuit metering,
measurement &
analysis

Which
application?



Which
functions?

					
		DIRIS A-10 <i>p. 76</i>	DIRIS A-14 DIN <i>p. 80</i>	DIRIS A-14 96 x 96 <i>p. 80</i>	
		CURRENT TRANSFORMERS			
General characteristics	Functions				
	Remote display				
	Number of loads	1	1	1	
	Mounting	DIN	DIN or 96*96	DIN or 96*96	
	Power supply	AC	AC	AC	
	All In One	•	•	•	
	Optional modules				
	Ethernet (Modbus TCP / Bacnet IP)	o / -	o / -	o / -	
	RS485 (Modbus / Bacnet MSTP)	• / -	• / -	• / -	
	Profibus DPV1				
Webserver / File export	o / -	o / o	o / o		
Max. number of inputs (digital / analogue)	1 / -				
Max. number of outputs (digital / analogue)	1 / -				
Manage energy consumptions	4-quadrant energy metering	•	•	•	
	Load curves (local memory)		•	•	
	Rebilling of energy (MID approved)		•	•	
	Multi-tariff management	2	4	4	
Monitor the electrical installation	Instantaneous, average, min and max values	•	•	•	
	Voltage unbalance measurement				
	Neutral current (measured / calculated)	- / •	- / •	- / •	
Check the power quality	Harmonic analysis (THD / Individual)	• / -	• / -	• / -	
	Dip and swell detection				
	Overcurrent detection				
	1/2 cycle RMS curves on events				
Manage the loads	Operating hours	•			
	Number of operations (info / alarm)				
	Protective device monitoring (on / off / tripped)	•			
	Predictive power analysis and load shedding				

•: integrated in the product.

o: optional via DIRIS-G or modules.

Which dimensions?

Which communication protocol?

Which options?



DIRIS A-20
p. 84

DIRIS A-30/A-41
p. 88

DIRIS A-60
p. 98

DIRIS B-10
p. 104

DIRIS B-30
p. 104

DIRIS A-40
Modbus
p. 94

DIRIS A-40
Modbus +
Profibus
p. 94

DIRIS A-40
Modbus +
Ethernet
p. 94

CURRENT TRANSFORMERS

SMART SENSORS

CURRENT TRANSFORMERS			SMART SENSORS				
1	1	1	•	•	•		
96 x 96	96 x 96	96 x 96	1 to 4	1 to 4	1		
AC	AC/DC	AC/DC	DIN	DIN	96 x 96		
			AC	AC	AC/DC		
•	•	•			•		
0/-	0/-	0/-	•	•	-/-	-/-	•/•
•/-	•/-	0/-	•/0	•/0	•/-	•/-	•/-
	0		0	0	-	•	-
0/0	Via DIRIS G		0/0	0/0	0/0	0/0	•/•
3/-	6/4	6/4		2/2	3/-		
1/-	6/4	6/4		2/2	2/-		
•	•	•	•	•	•		
	0	•		•	•		
			8	8	4		
•	•	•	•	•	•		
	•	•	•	•	•		
-/•	• (with A-41)	•	•/•	•/•	-/•		
•/-	•/•	•/•	•/-	•/•	•/•		
		•		•	•		
		•		•	•		
•	•	•	•	•	•		
•/-	•/-	•/-	•/-	•/•	•/•		
•	•	•	•	•	•		
	•	•		•	•		



Selection guide

Active energy meters and pulse concentrators

COUNTIS E

Single-circuit metering,
measurement &
analysis

Which type
of network?

Which load
current?

Network - Input current	Single-phase Direct up to 40 A			Single-phase Direct up to 80 A				Three-phase Direct up to 80 A	
Active energy meters: <i>COUNTIS E</i>	<i>E00/E02</i> <i>p. 112</i>	<i>E03/E04</i> <i>p. 112</i>	<i>E05/E06</i> <i>p. 112</i>	<i>E11/E12</i> <i>p. 114</i>	<i>E13/E14</i> <i>p. 114</i>	<i>E15/E16</i> <i>p. 114</i>	<i>E17/E18</i> <i>p. 114</i>	<i>E21/E22</i> <i>p. 116</i>	<i>E23/E24</i> <i>p. 116</i>

Main specifications

MID: EN 50470 module B + D certification	• (E02)	• (E04)	• (E06)	• (E12)	• (E14)	• (E16)	• (E18)	• (E22)	• (E24)
RS485 Modbus		•			•				•
M-Bus			•			•			
Ethernet Modbus TCP/RTU							•		
Width	1 module	1 module	1 module	2 modules	2 modules	2 modules	2 modules	4 modules	4 modules
Input voltage	230 VAC	230 VAC	230 VAC	230 VAC	230 VAC	230 VAC	230 VAC	230 ... 400 VAC	230 ... 400 VAC

Functions

Total/partial energy kWh	•/•	•/•	•/•	•/•	•/•	•/•	•/•	•/•	•/•
Active power / Reactive power	•/•	•/•	•/•	•/•	•/•	•/•	•/•	•/•	•/•
Dual tariff for kWh		•	•	•	•	•	•	•	•
Total/partial energy kvarh	•/•	•/•	•/•	•/•	•/•	•/•	•/•	•/•	•/•
kVA		via COM	via COM		•	•	•	•	•
Load curve									
Measurement (I, V, P, Q, S, F and PF)	•	•	•	•	•	•	•	•	•
CT connection indication									
Birectional (energy consumption and production)	•	•	•	•	•	•	•	•	•
Integrated web server							•		
Compatibility with Webview		•			•		•		•

Accuracy

Active energy (IEC 62053-21)	class 1	class 1	class 1	class 1	class 1	class 1	class 1	class 1	class 1
Reactive energy (according to IEC 62053-23)	class 2	class 2	class 2	class 2	class 2	class 2	class 2	class 2	class 2
Active energy (EN 50470)	class B (E02)	class B (E04)	class B (E06)	class B (E12)	class B (E14)	class B (E16)	class B (E18)	class B (E22)	class B (E24)

Characteristics

Metrological LED	•	•	•	•	•	•	•	•	•
Pulse output	100 Wh	100 Wh	100 Wh	100 Wh	100 Wh	100 Wh		100 Wh	100 Wh
Sealing cover (MID version only)	• (E02)	• (E04)	• (E06)	• (E12)	• (E14)	• (E16)	• (E18)	• (E22)	• (E24)
Phase/neutral inversion protection									

Pulse concentrator	<i>COUNTIS ECi2</i> <i>p. 124</i>	<i>COUNTIS ECi3</i> <i>p. 124</i>
Case	4 modules	4 modules
Logical inputs	7	7
Analogue inputs		2
ON/OFF output (alarm)	1	1
Partial, total, daily, weekly or monthly kWh or other types of data (liters, m³...)	•	•
Load curve from 8 to 30 minutes	•	•
RS485 Modbus	•	•



Three-phase Direct up to 80 A		Three-phase Direct up to 100 A			Three-phase CT/5 A					
<i>E25/E26</i> <i>p. 116</i>	<i>E27/E28</i> <i>p. 116</i>	<i>E30/E31/E32</i> <i>p. 118</i>	<i>E33/E34</i> <i>p. 118</i>	<i>E35/E36</i> <i>p. 118</i>	<i>E41/E42</i> <i>p. 120</i>	<i>E43/E44</i> <i>p. 120</i>	<i>E45/E46</i> <i>p. 120</i>	<i>E47/E48</i> <i>p. 120</i>	<i>E50</i> <i>p. 118</i>	<i>E53</i> <i>p. 118</i>
• (E26)	• (E28)	• (E32)	• (E34)	• (E36)	• (E42)	• (E44)	• (E46)	• (E48)		
			•			•				•
•				•			•			
	•							•		
4 modules	4 modules	7 modules	7 modules	7 modules	4 modules	4 modules	4 modules	4 modules	96x96	96x96
230 ... 400 VAC	230 ... 400 VAC	230 ... 400 VAC	230 ... 400 VAC	230 ... 400 VAC	230 ... 400 VAC	230 ... 400 VAC	230 ... 400 VAC	230 ... 400 VAC	86 ... 520 VAC	86 ... 520 VAC
•/•	•/•	•/• (E31)	•/via COM (E34)	•/via COM (E36)	•/•	•/•	•/•	•/•	•/•	•/•
•/•	•/•	•/-	•/via COM	•/via COM	•/•	•/•	•/•	•/•	•/•	•/•
•	•	• (E31/E32)	up to 4 via com	up to 4 via com	•	up to 4 via com	up to 4 via com	up to 4 via com	•	•
•/•	•/•		via COM	via COM	•/•	•/•	•/•	•/•	•	•
•	•		via COM	via COM	•	•	•	•	•	•
			via COM	via COM		via COM	via COM	via COM		
•	•				•	•	•	•	•	•
					•	•	•	•	•	•
•	•		• (E33)	• (E35)	•	•	•	•		
	•								•	•
	•		•			•		•		•
class 1	class 1	class 1	class 1	class 1	class 1	class 1	class 1	class 1	class 1	class 1
class 2	class 2				class 2	class 2	class 2	class 2	class 2	class 2
class B (E26)	class B (E28)	class B (E32)	class B (E34)	class B (E36)	class C (E42)	class C (E44)	class C (E46)	class C (E48)		
•	•	•	•	•	•	•	•	•		
100 Wh	100 Wh				configurable	configurable	configurable	configurable		
• (E26)	• (E28)	• (E32)	• (E34)	• (E36)	• (E42)	• (E44)	• (E46)	• (E48)		
		•	•	•				•	•	•

COUNTIS Eci pulse concentrator

Enables pulses from water, gas, compressed air, electricity meters or even analogue sensors (light, temperature, wind etc.) to be registered and stored. All data can be centralised and managed by an energy efficiency software via RS485 communication.

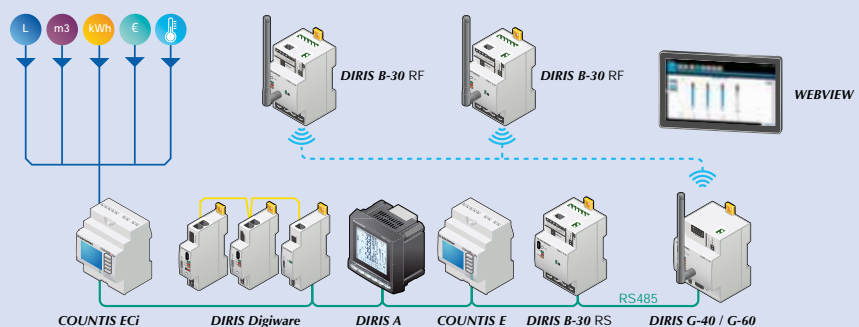

COUNT_344_B_X4I



Selection guide

Software solutions for energy monitoring and analysis

What are the features?

For what size of project?

Where is the data stored?

	WEBVIEW-S	WEBVIEW-M		WEBVIEW-L	N'VIEW
Hosting of the application ⁽¹⁾	DIRIS A-40 Ethernet <i>p. 156</i>	DIRIS G <i>p. 156</i>	DIRIS Digiware D-70 <i>p. 156</i>	DATALOG H80/H81 <i>p. 156</i>	Cloud <i>p. 158</i>
Data collection					
Maximum number of connected measurement devices	1	32	32	100 (WEBVIEW-L100) 200 (WEBVIEW-L200)	Unlimited
Import of data from files					•
Interfacing to third-party applications				via connector	via connector
Export of data in CSV format	•	DIRIS G-50/G-60	•	•	•
Real time monitoring					
U/V voltages and currents I	•	•	•	•	n/a ⁽²⁾
Powers P, Q, S, Power factor	•	•	•	•	n/a ⁽²⁾
Quality monitoring THDi, THDu, THDv, K factor, Harmonic analysis up to 63 rd	•	•	•	•	n/a ⁽²⁾
Energy metering Ea+, Ea-, Er+, Er-, Es	•	•	•	•	n/a ⁽²⁾
Pulse counting	•	•	•	•	n/a ⁽²⁾
Input/Output monitoring	•	•	•	•	n/a ⁽²⁾
Measurement history U, V, I, P, Q, S,	•	DIRIS G-50/G-60	•	•	n/a ⁽²⁾
Energy analysis					
Energy consumption analysis	•	DIRIS G-50/G-60	•	•	•
Multi-parameter analysis				•	•
Compare time periods					•
Active energy analysis					•
Power demand analysis					•
Cost analysis					•
Energy performance indicators					•
Linear regression					•
Measurement and verification (IPMVP method)					•
Predictive energy consumption					•
Alarm management					
Product alarms	•	•	•	•	
Software alarms					•
Alarms history	•	•	•	•	•
Transmission of alarms	e-mail	e-mail	e-mail	e-mail	e-mail and SMS
Reporting management					
Creation of customised reports					•
Automatic dispatch of reports by e-mail					•
Creation of customised dashboards					•
Site mapping					Via Google Maps
Customisable user interface			Photoview	Photoview	Synoptic App
Hierarchy management		DIRIS G-50/G-60	•	•	•
Conformity to standards					
Energy Server Standard - IEC 62974-1		•	•	•	

⁽¹⁾ For more information on the hardware please refer to the appropriate catalogue pages.

⁽²⁾ N'VIEW is a software solution intended for energy management purposes only.

Architecture

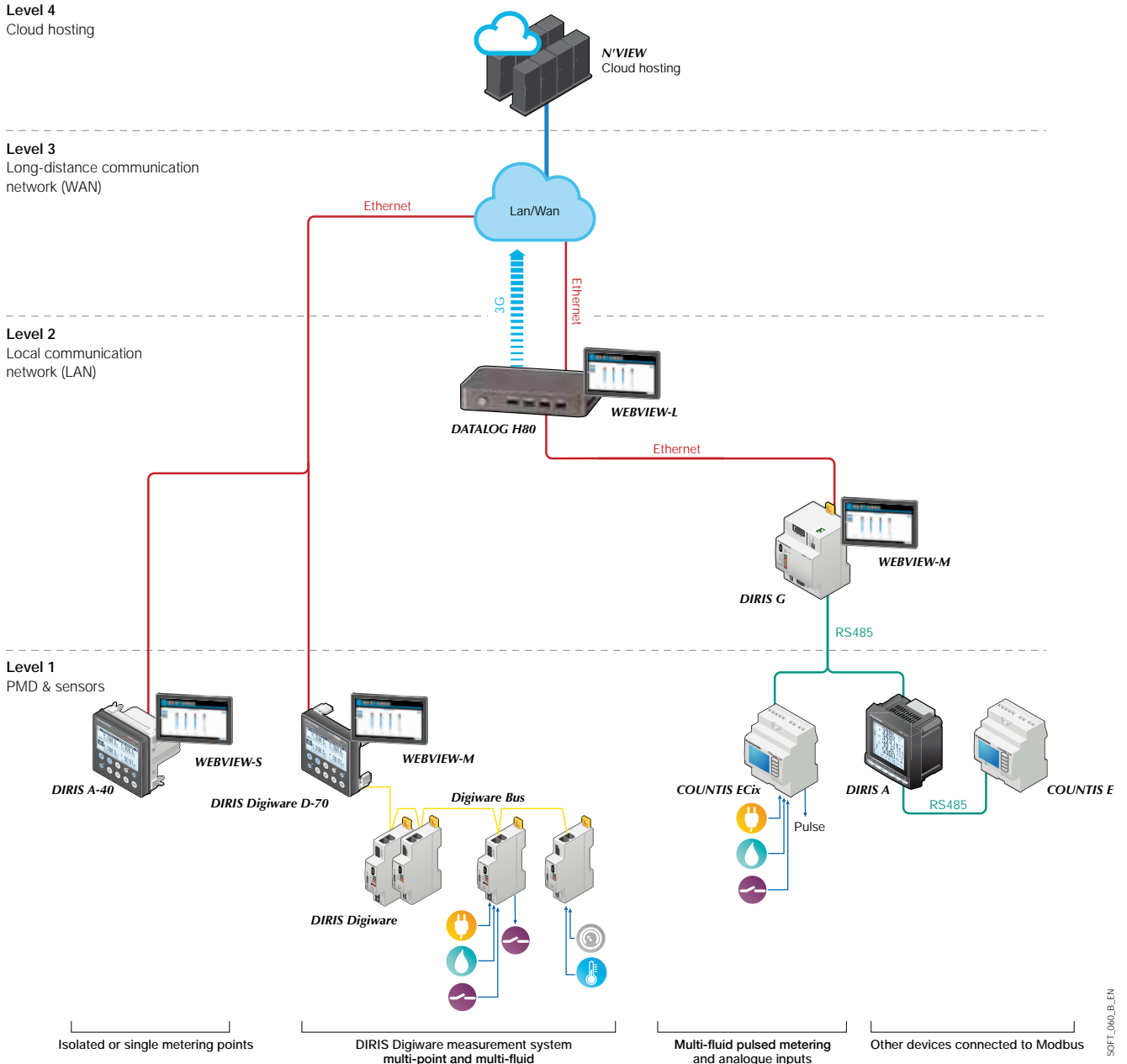

Expert Services

Require integration onto your network?

No problem for our Expert Services team. They work out all the details of the measurement schedule, the complete integration of all devices in your energy management system, the configuration of your software application, the training of your teams and details of operational support. For further information, please contact your nearest Socomec office.



DIRIS Digiware D and C

Control and power supply interfaces

Multi-circuit metering & measurement



DIRIS Digiware D-40/D-50/D-70
Centralisation and display of data



DIRIS Digiware C-31
Centralisation

The solution for

- > Industry
- > Building
- > Infrastructure
- > Data centers



Strong points

- > Centralising and displaying measurement data
- > A single power supply for the entire system
- > A single RS485 or Ethernet output for the entire system
- > WEBVIEW-M embedded web server

Compliance with standards

- > IEC 61557-12



- > ISO 14025



- > UL



Create your project

- > Find the best DIRIS Digiware configuration:
www.meter-selector.com



Configuration with EasyConfig.

Function

DIRIS Digiware D-40, D-50 and D-70

DIRIS Digiware D remote displays allow:

- a local view of the data from DIRIS Digiware modules
- a power supply to the DIRIS Digiware modules,
- access to this data over Ethernet (D-50/D-70) or RS485 (D-40).

DIRIS Digiware D-50 and D-70 displays also act as a gateway, centralising measurements from DIRIS Digiware, DIRIS A, DIRIS B and COUNTIS E devices and making them available over Ethernet.

With the DIRIS Digiware D-70 display, data can be visualized on WEBVIEW-M, the "Power & Energy monitoring" embedded web server.

DIRIS Digiware screens are 24 VDC powered.

Advantages

DIRIS Digiware D

- High-resolution graphic screen
- Embedded web server (DIRIS Digiware D-70)
- Multi-protocols (Modbus, BACnet, SNMP)
- 24 VDC SELV (Safety Extra Low Voltage) power supply elimination of hazardous voltage on cabinet doors.
- Ergonomic and easy to use with 10 direct access buttons for:
 - measurement information,
 - output selection,
 - equipment configuration.
- Centralising measurement points:
 - circuit selection,
 - displaying data.

DIRIS Digiware C-31

For applications without a local display DIRIS Digiware C-31 interfaces centralise all the system data.





An RS485 Modbus output allows them to provide all this information to energy efficiency software (DIRIS G communication gateways are available for communication via Ethernet - Modbus TCP).

DIRIS Digiware C-31 interfaces and C-32 repeaters are 24 VDC powered.

DIRIS Digiware C-31

Compact: Centralise your measurement data on 1 module without a local screen, for a complete system:

- single 24 V power supply (no dangerous voltage on DIRIS Digiware modules for a connection with no interruption),
- a single RS485 communication.

Application	Control and power supply interface			
				
DIRIS Digiware	C-31	D-40	D-50	D-70
Digiware input	•	•	•	•
RS485 input			•	•
RS485 Modbus output	•	•		
Ethernet output			Modbus BACnet IP SNMP v1, v2, v3	Modbus BACnet IP SNMP v1, v2, v3
WEBVIEW-M web server				•

Functions



WEBVIEW-M

Embedded web server in the DIRIS Digiware D-70 display

WEBVIEW allows the display and remote monitoring of all the electric parameters measured by up to 32 devices. They are displayed in the form of overview screens, graphs or tables for clear and user-friendly analysis.

Access to Webview is made by a web browser on a PC or tablet and offers multiple features such as the automatic export of data via FTPS or e-mail notification in the presence of alarms (SMTP).

The Photoview application is available via the Webview interface embedded in the DIRIS Digiware D-70 display. It allows the display of electrical quantities on a customised background picture such as a cabinet, a wiring diagram or the map of a site.

Accessories

DIN rail mounting kit

Only compatible with DIRIS Digiware D-50v2 and D-70v2 displays, the accessory allows you to install the system display on a din rail. This kit is not included with the displays and must be ordered separately.



DIRIS Digiware D and C

Control and power supply interfaces

Dimensions (mm)

DIRIS Digiware D-40

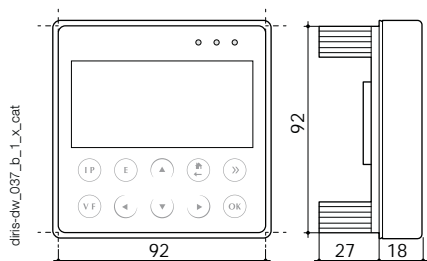

DIRIS Digiware D-50/D-70

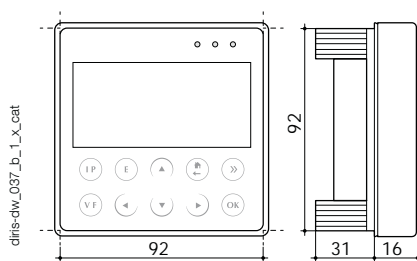

DIRIS Digiware C-31

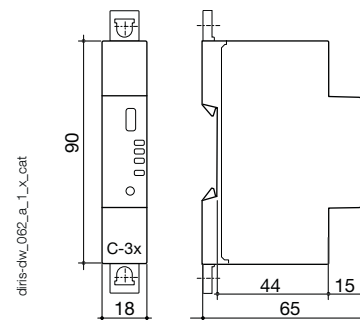

Configuration

Equipment consumption

Product	Power delivered (W)	Power consumed (W)
Power supply		
P15 100-240 VAC / 24 VDC	15	
P30 100-240 VAC / 24 VDC	20	
Cables		
50 metre package		1.5
System interfaces		
DIRIS Digiware D-40		2
DIRIS Digiware D-50/D-70		2.5
DIRIS Digiware C-31		0.8
Module voltage		
DIRIS Digiware U-xx		0.72
DIRIS Digiware U-3xdc		0.6
Current modules		
DIRIS Digiware I-3x		0.52
DIRIS Digiware I-4x		1.125
DIRIS Digiware I-6x		0.7
DIRIS Digiware I-3xdc (+ 3 DC current sensors)		2
DIRIS Digiware S-xx		0.35
Input/output modules		
DIRIS Digiware IO-10/IO-20		0.5
Repeater		
DIRIS Digiware C-32		1.5

Calculation rules for the max. number of products on the Digiware Bus

The total power consumed by the equipment connected to the Digiware Bus must not exceed the power from the 24 VDC supply.

The power supply must not exceed 20 W/70°C or 27 W/40°C.

Size with P15 power supply (ref: 4829 0120) delivering 15 W

For example, it is possible to use

- 1 DIRIS Digiware D-40 display (2 W)
- 1 DIRIS Digiware voltage module U-xx (0.72 W)
- 50 metres of cable (1.5 W)

and

- 20 DIRIS Digiware current modules I-3x (20 x 0.52 = 10.4 W)
- ⇒ **Total power = 14.62 W**

or

- 9 DIRIS Digiware current modules I-4x (9 x 1.125 = 10.125 W)
- ⇒ **Total power = 14.345 W.**

Size with a 24 VDC power supply delivering a maximum of 20 W (Power supply P30 ref: 4729 0603)

For example, it is possible to use

- 1 DIRIS Digiware D-40 display (2 W)
- 1 DIRIS Digiware voltage module U-xx (0.72 W)
- 50 metres of cable (1.5 W)

and

- 30 DIRIS Digiware current modules I-3x (30 x 0.52 = 15.6 W)
- ⇒ **Total power = 19.82 W**

or

- 14 DIRIS Digiware current modules I-4x (14 x 1.125 = 15.72)
- ⇒ **Total power = 19.97 W.**

Repeater

Whenever the power consumption is higher than 20 W or the distance is greater than 100 m, a DIRIS Digiware C-32 repeater is required.

In a DIRIS Digiware system, a maximum of 2 repeaters may be used.

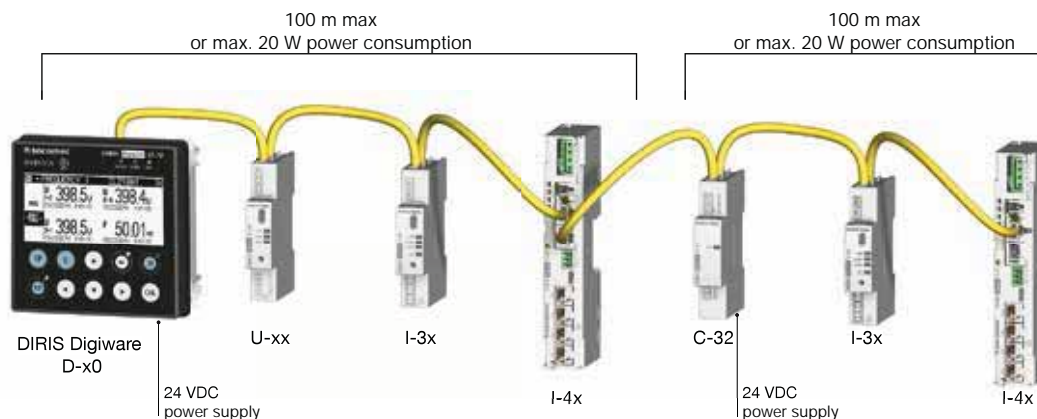

Connections

DIRIS Digiware D-40

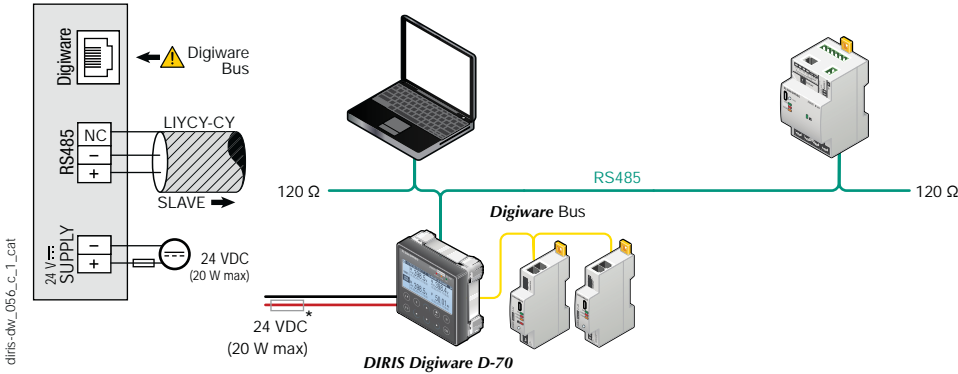

(*) 1A / 24 VDC fuse protection is recommended if the 24 VDC power supply is not provided by Socomec.

DIRIS Digiware D-50

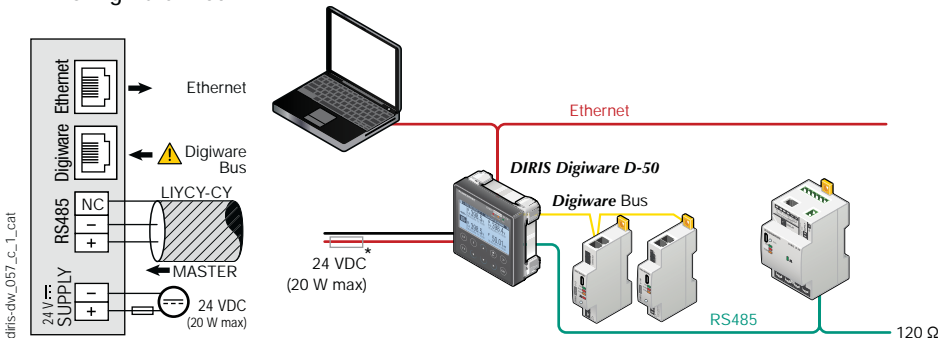

(*) 1A / 24 VDC fuse protection is recommended if the 24 VDC power supply is not provided by Socomec.

DIRIS Digiware D-70

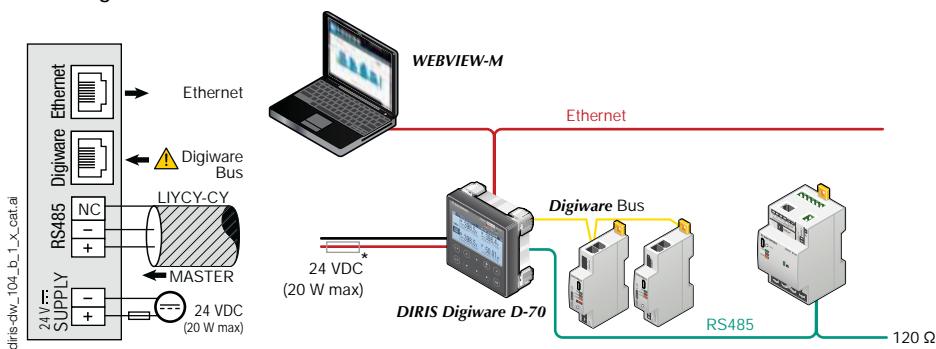

(*) 1A / 24 VDC fuse protection is recommended if the 24 VDC power supply is not provided by Socomec.

Connections (continued)

DIRIS Digiware C-31

Power supply

Digiware bus

Communication

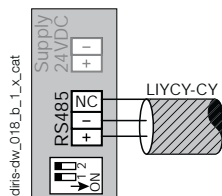
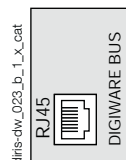
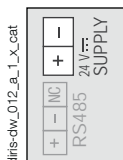

DIRIS Digiware C-31

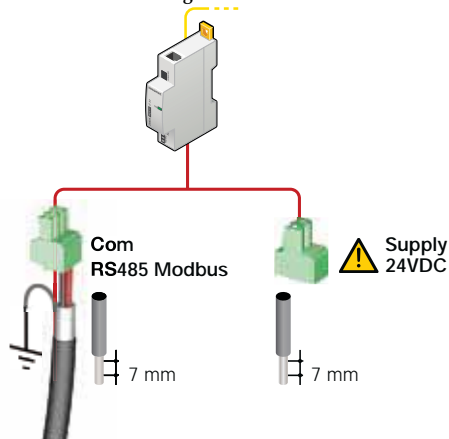

DIRIS Digiware C-32

Power supply

Digiware bus

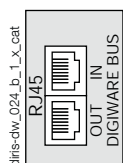
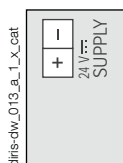

Technical characteristics

Electrical characteristics

DIRIS Digiware C-31	
Input voltage	24 VDC \pm 20 % - 20 W max
Connection	Removable screw terminal block, 2 positions, stranded or solid 0.2-2.5 mm ² cable
P15 power supply	Characteristics: 100-240 VAC/ 24 VDC - 0.63 A - 15 W Modular format - Dimensions (H x L): 90 x 36 mm

Communication specifications

Digiware Bus	
Function	Connection between DIRIS Digiware modules
Cable type	Specific Socomec cable with RJ45 connections
RS485	
Connection type	2 to 3 half duplex wires
Protocol	Modbus RTU
Baudrate	1200 to 115 200 bauds
Function	Data configuration and reading
Location	Single-point on DIRIS Digiware C

Mechanical features

Casing type	DIN-rail mounting module and base
Casing protection index	IP20 / IK06
Front panel protection index	IP40 on the nose in modular assembly / IK06

Environmental specifications

Ambient operating temperature	-10 to +70°C
Storage temperature	-25 to +70°C
Operating humidity	55 °C / 97% HR
Operating altitude	< 2000 m

DIRIS Digiware D-40/D-50/D-70 features

Mechanical characteristics		
Type of screen	Capacitive touch-screen technology, 10 keys	
Screen resolution	350 x 160 pixels	
Front panel protection index	IP65	
Communication		
Ethernet RJ45 10/100 Mbps	Gateway function (D-50/D-70): Modbus TCP BACnet IP SNMP v1, v2, v3	
RJ45 Digiware	Control and power supply interface function	
RS485 2-3 wires	Modbus RTU communication function - output for D-40 - input for D-50 / D-70	
USB	Upgrade and configuration via type B micro USB connector	
Electrical characteristics		
Power supply	24 VDC +10 % / -20%	
Power consumption	2.5 VA	
Battery lifetime	10 years	
Environmental specifications		
Storage temperature	-20 to +70°C	
Operating temperature	-10 to +55°C	
Humidity	95% at 40°C	
Installation category, degree of pollution	CAT III, 2	
Ports	D-40	D-50/D-70
Inputs	Digiware	Digiware RS485
Outputs	RS485	Ethernet

References

DIRIS Digiware		Reference
D-40	Multipoint display, RS485 output	4829 0199
D-50	Multipoint display, Ethernet output	4829 0204
D-70	Multipoint display, Ethernet output + embedded web server	4829 0203
C-31	System interface - no display, RS485 output	4829 0101
C-32	Repeater	4829 0103
Power supply		Reference
P15	Power supply 100-240 VAC/ 24 VDC 15 W	4829 0120
P30	Power supply 100-240 VAC/ 24 VDC 20 W	4729 0603
Digiware connection cables		Reference
RJ45 cables for Digiware Bus	Length 0.06 m	4829 0189
	Length 0.10 m	4829 0181
	Length 0.20 m	4829 0188
	Length 0.50 m	4829 0182
	Length 1 m	4829 0183
	Length 2 m	4829 0184
	Length 5 m	4829 0186
	Length 10 m	4829 0187
50 m reel + 100 connectors		4829 0185
Termination for Digiware Bus (supplied with interfaces C and D)		4829 0180
USB configuration cable		4829 0050
Single-point display		Reference
DIRIS D-30 ⁽¹⁾	Single-point display for DIRIS Digiware I-4x and DIRIS B	4829 0200
Accessories		To be ordered in multiples of
Fuse holder to protect voltage inputs (type RM) 1 pole + neutral		4
gG 10x38 0.5 A fuses		10
DIN rail mounting kit for D-50 and D-70 v2 displays		1
		Reference
		5701 0017
		6012 0000
		4829 0230

(1) DIRIS D-30 display characteristics, see page "DIRIS B".

Expert Services

Require integration onto your network?

No problem for our "Expert Services" team. They will fully integrate all your SOCOMEC devices, **audit** your system, **commission** selected equipment and **train** your staff on its use.

For further information, please contact your nearest SOCOMEC branch.



DIRIS Digiware U

Voltage acquisition module

Multi-circuit metering & measurement



diris-dw_005_a_cat

DIRIS Digiware U-10/U-20/ U-30



Configuration with EasyConfig, see page 160.

Function

The DIRIS Digiware U module measures voltage for the entire system. This pools together all voltage measurements.

The Digiware RJ45 Bus allows you to pass voltage measurements as well as power supply and communication to all connected products.

Advantages

- 1 single voltage measurement point for the entire system.
- Single point of protection for voltage measuring.
- A complete, dedicated solution:
 - metering,
 - monitoring voltage,
 - quality analysis of the supplied voltage.
- No hazardous voltage on cabinet doors.
- Adapted to all types of network: single-phase, three-phase.

The solution for

- > Industry
- > Building
- > Infrastructure
- > Data center



Strong points

- > 1 single voltage measurement point for the entire system
- > Plug & Play
- > Compact



RJ45 (Digiware Bus) cables are available.

Conformity to standards

- > IEC 61557-12



- > ISO 14025





- > UL



Create your project

- > Find the best DIRIS Digiware configuration: www.meter-selector.com



Application	Voltage measurement module		
	Metering	Monitoring	Analysis
			
	U-10	U-20	U-30
DIRIS Digiware U			
Multi-measurement			
U12, U23, U31, V1, V2, V3, f	•	•	•
U system, V system			•
Ph/N unbalance			•
Ph/Ph unbalance			•
Quality analysis			
THDv1, THDv2, THDv3, THDu12, THDu23, THDu31		•	•
Individual harmonics U & V (up to 63rd)			•
Voltage dips, swells and interruptions (EN 50160)			•
Alarms			
On threshold			•
History of average values			
45 days (max)			•
Format			
Width/number of modules	18 mm / 1	18 mm / 1	18 mm / 1

Dimensions (mm)

DIRIS Digiware U

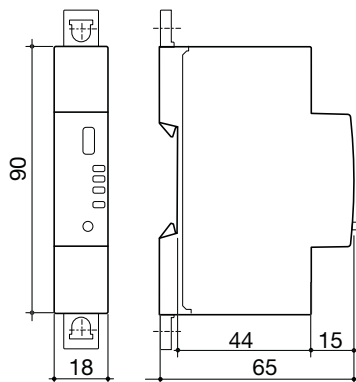

Specifications

Measuring characteristics

Voltage measurement - DIRIS Digiware U	
Characteristics of the network measured	50-300 VAC (Ph/N) - 87-520 VAC (Ph/Ph) - CAT III
Frequency range	45 ... 65 Hz
Frequency accuracy	Class 0.02
Network type	Single-phase/ Two-phase / Two-phase with neutral / Three-phase / Three-phase with neutral
Measurement by voltage transformer	Primary: 400 000 VAC Secondary: 60, 100, 110, 173, 190 VAC
Input consumption	≤ 0.1 VA
Permanent overload	300 VAC Ph/N
Accuracy of voltage measurement	Class 0.2
Connection	Removable screw terminal block, 4 positions, stranded or solid 0.2 ... 2.5 mm ² cable

Communication specifications

USB	
Protocol	Modbus RTU on USB
Function	Configuration of DIRIS Digiware U and I modules
Location	On each DIRIS Digiware U and I measurement module
Connection	Type B micro USB connector

References

Digiware connection cables		Reference
RJ45 cables for Digiware Bus	Length 0.06 m	4829 0189
	Length 0.10 m	4829 0181
	Length 0.20 m	4829 0188
	Length 0.50 m	4829 0182
	Length 1 m	4829 0183
	Length 2 m	4829 0184
	Length 5 m	4829 0186
	Length 10 m	4829 0187
Reel 50 m + 100 connectors		4829 0185
Replacement reference: Digiware bus terminating resistor (supplied with C and D devices)		4829 0180
USB configuration cable		4829 0050

DIRIS Digiware		Reference
U-10	Metering	4829 0105
U-20	Monitoring	4829 0106
U-30	Analysis	4829 0102

Accessories		
Description of accessories	To be ordered in multiples of	Reference
Fuse holder to protect voltage inputs (type RM) 3 pole	4	5701 0018
gG 10x38 0.5 A fuses	10	6012 0000



DIRIS Digiware S

Current acquisition module with integrated sensors

Multi-circuit metering & measurement



DIRIS Digiware S



Configuration with EasyConfig.

Function

DIRIS Digiware S current acquisition modules have 3 integrated current sensors for the measurement of electrical circuits up to 63 A.

Positioned directly above or below the protective devices, they are associated with the DIRIS Digiware U voltage measurement module to measure consumption, and to monitor the electrical installation and the quality of the power supply.

Advantages

Plug & Play

- Save wiring time: the current sensors are integrated in the module.
- Quick RJ45 connection between modules.
- Positioning possible upstream or downstream of the protective device.

Multi-circuit

Multiple DIRIS Digiware S modules can be used within the measurement system enabling the monitoring of a large number of loads.

Compact

- A measurement module offering the best compactness/performance ratio of the market.
- Matches the pitch of the protective device.

Accurate

- Class 0.5 for active energy in accordance with the IEC 61557-12 standard, allowing accurate measurements over a wide range of currents.

Functional diagram

Downstream

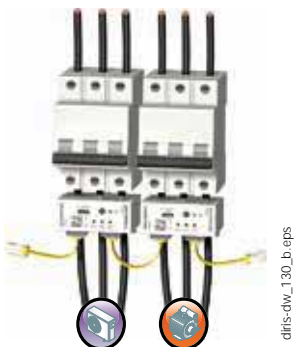

Upstream

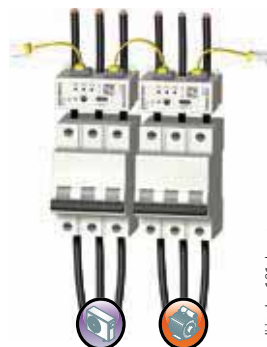

The DIRIS Digiware S measurement module can be mounted upstream or downstream of the protective device solving issues of space constraints.

The solution for

Distribution boards in:

- > Data center
- > Building
- > Industry



Strong points

- > Plug & Play
- > Multi-circuit
- > Compact



RJ45 (Digiware Bus) cables are available.

Integrated technologies



PreciSense



AutoCorrect



VirtualMonitor

For more information see our website www.socomec.com

Compliance with standards

- > IEC 61557-12





- > ISO 14025



- > UL 257746



Application	Current measurement module with integrated sensors		
	Metering	Analysis	Monitoring
			
DIRIS Digiware S	S-130	S-135	S-Datacenter
Number of current inputs	3	3	3
Basic current I _b	10 A	10 A	10 A
Maximum current I _{max}	63 A	63 A	63 A
Load type accepted	1P + N 2P / 2P + N 3P / 3P + N	1P + N 2P / 2P + N 3P / 3P + N	1P + N
Metering			
± kWh, ± kvarh, kVAh	•	•	•
Multi-tariff (max 8)		•	
Load curves		•	•
Multi-measurement			
I1, I2, I3, In, ΣP, ΣQ, ΣS, ΣPF	•	•	•
P, Q, S, PF per phase		•	•
Predictive power		•	
Current unbalance (Inba, Inb, ldir, linv, lhom)		•	
Phi, cos Phi, tan Phi		•	•
Quality			
THDi1, THDi2, THDi3, THDin		•	•
Individual harmonics I (up to 63rd)		•	
Crest factors U, V, I		•	
K factor		•	
Overcurrents		•	
Alarms			
Thresholds and combinations		•	•
Load level			•
Wiring errors		•	•
Protective device		•	•
Trends			
Average values		•	•
Format			
Width	54 mm	54 mm	54 mm

Mounting accessories

Temporary MCB insert
(for use during panel assembly)



diris-dw_137_a.eps

DIN rail and back plate mounting

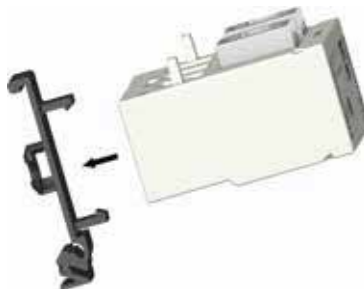

diris-dw_138_a.eps

Cable tie tether



diris-dw_139_a.eps

DIRIS Digiware S

Current acquisition module with integrated sensors

Dimensions (mm)

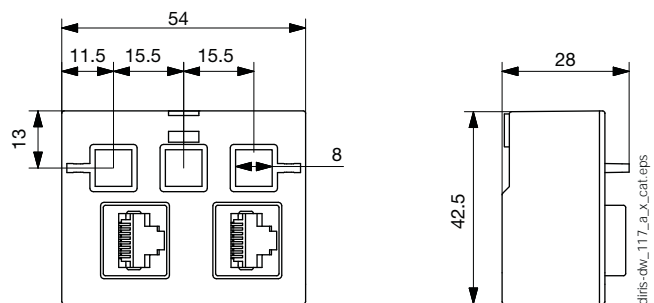

Connections

Current is measured by the integrated inputs I01, I02 and I03 on the DIRIS Digiware S module.

3P+N - 3CT

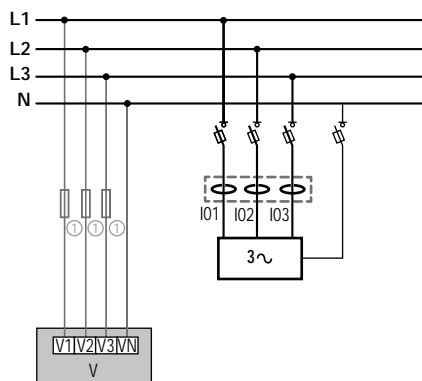

diris-dw_118_a_x_cat.ai

3P - 3 CT

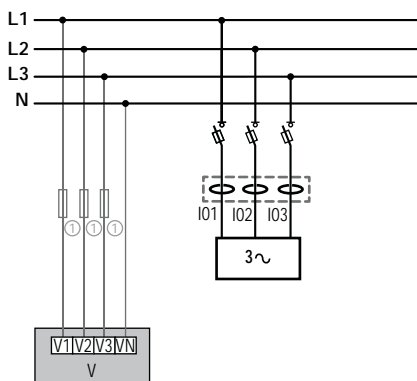

2P+N - 2CT & 2P+N - 1CT

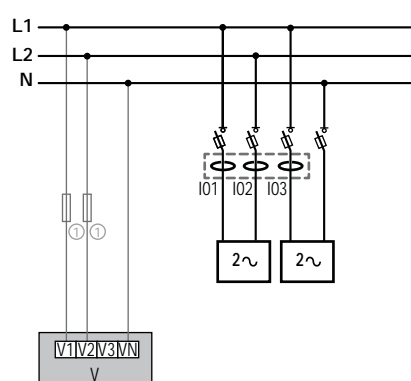

diris-dw_119_a_x_cat.ai

diris-dw_120_a_x_cat.ai

1P+N - 1 CT (3x)

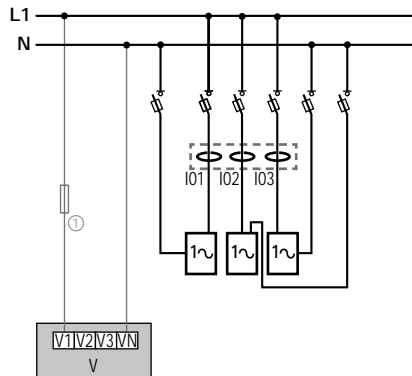

diris-dw_121_a_x_cat.ai

3P+N - 1CT (3x)

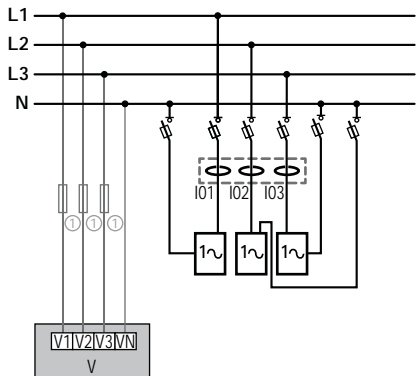

diris-dw_122_a_x_cat.ai

2P+N - 1CT (3x)

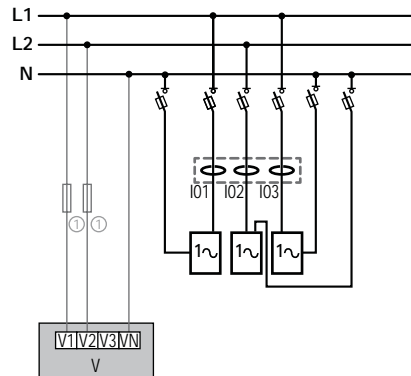

diris-dw_123_a_x_cat.ai



Fuses : 0.5 A gG/BS 88 2 A gG/0.5 A class CC

Technical characteristics

Measurement characteristics

Measurement of current	
Number of current inputs	3
Associated current sensors	Integrated in the product
Basic current I _b	10 A
Maximum current I _{max}	63 A
Current measurement accuracy	Class 0.5 IEC 61557-12
Measurement of energy	
Accuracy of active energy	Class 0.5 IEC 61557-12
Accuracy of reactive energy	Class 1 IEC 61557-12

Mechanical characteristics

Casing type	DIN rail or back plate mounting
Casing protection index	IP20 / IK08
Weight	63 g
Module power consumption	0.35 VA

Communication specifications

Digiware BUS	
Function	Connection between DIRIS Digiware S, U, I modules and system interfaces
Cable type	Specific Socomec cable with RJ45 connections
USB	
Protocol	MODBUS RTU on USB
Function	Configuration of DIRIS Digiware modules
Location	On each DIRIS Digiware module
Connection	Type B micro USB connector

Environmental specifications

Ambient operating temperature	-10 ... +55°C
Storage temperature	-25 ... +70°C
Operating humidity	40°C / 95% RH
Operating altitude	< 2000 m

References

DIRIS Digiware S	Reference
S-130	Metering - 3 integrated current inputs 4829 0160
S-135	Analysis - 3 integrated current inputs 4829 0161
S-Datacenter	Single-phase monitoring - 3 integrated current inputs 4829 0162
Accessories	Reference
DIN rail and back plate mounting clip (x10)	4829 0195
Temporary MCB insert (x10)	4829 0196

Digiware connection cables	Reference	
RJ45 cables for Digiware Bus	Length 0.06 m ⁽¹⁾	4829 0189
	Length 0.10 m	4829 0181
	Length 0.20 m	4829 0188
	Length 0.50 m	4829 0182
	Length 1 m	4829 0183
	Length 2 m	4829 0184
	Length 5 m	4829 0186
	Length 10 m	4829 0187
	50 m reel + 100 connectors	4829 0185
Termination for Digiware Bus (supplied with interfaces C and D)	4829 0180	
USB configuration cable	4829 0050	

(1) The RJ45 6 cm cables can be used on 3-pole or 4-pole protective devices.

Expert Services

Require integration onto your network?

No problem for our "Expert Services" team. They will fully integrate all your SOCOMEC devices, **audit** your system, **commission** selected equipment and **train** your staff on its use.

For further information, please contact your nearest SOCOMEC branch.



DIRIS Digiware I

Current acquisition modules

Multi-circuit metering & measurement

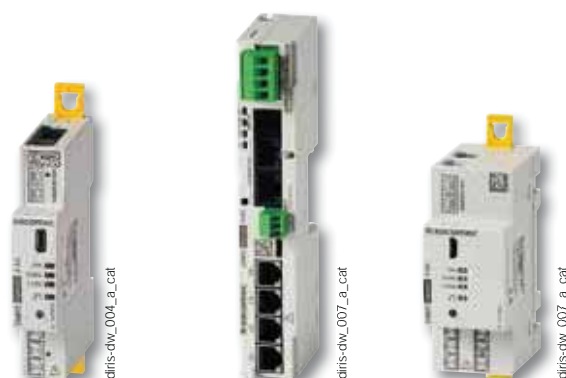

DIRIS Digiware I-3x

DIRIS Digiware I-4x

DIRIS Digiware I-6x

The solution for

- > Industry
- > Building
- > Infrastructure
- > Data center



Strong points

- > Multi-circuit
- > Plug and Play
- > Compact
- > High-precision measurement chain

Integrated technologies



For more information, see page 12.

Conformity to standards

- > IEC 61557-12



- > ISO 14025



- > UL



Create your project

- > Find the best DIRIS Digiware configuration:
www.meter-selector.com



Configuration with EasyConfig, see page 160.

Function

DIRIS Digiware I modules measure consumption and monitor the system at the closest point to the loads. The flexibility of these modules allows you to allocate the loads to be measured or monitored through independent current inputs.

For example:

- 1 three-phase load,
- 3 single-phase loads.

The RJ45 and RJ12 connections allow you to connect modules very quickly and to automatically configure connected current sensors:

- communication address,
- load type,
- sensor type and ratio,
- automatic rating and verification of current travel direction.

Wiring errors are also prevented and installation is simplified.

Advantages

- RJ45 and RJ12 rapid connection.
- Available with 3, 4 or 6 inputs.
- Single-output or multi-output for maximum optimisation of the number of products.
- Compact format: 1 or 2 modules sized for integration at the closest point to the loads.
- A complete, dedicated solution:
 - metering,
 - monitoring,
 - quality analysis.
- Compliant with standard IEC 61557-12, guaranteeing the quality and accuracy of the system:
 - class 0.5 for the 2 - 120% rated current global measurement chain In (with TE/TF current sensors).

Application	Current measurement modules							
	Metering		Monitoring	Analysis	Monitoring	Analysis	Metering	
DIRIS Digiware I	I-30	I-31	I-33	I-35	I-43	I-45	I-60	I-61
Number of current inputs	3	3	3	3	4	4	6	6
Metering								
± kWh, ± kvarh, kVAh	•	•	•	•	•	•	•	•
Load curves		•		•		•		•
Multi-tariff		•		•		•		•
Multi-measurement								
I1, I2, I3, In, ΣP, ΣQ, ΣS, ΣPF	•	•	•	•	•	•	•	•
P, Q, S, PF per phase			•	•	•	•		
Predictive power				•		•		
Current unbalance (Inba, Idir, linv, Ihom, Inb)				•		•		
Phi, cos Phi, tan Phi				•		•		
Quality								
THDi1, THDi2, THDi3, THDIn			•	•	•	•		
Individual harmonics I (up to 63rd)				•		•		
Overcurrents				•		•		
Alarms								
On threshold				•		•		
Inputs/outputs					2/2	2/2		
History of average values								
45 days (max)				•		•		
Format								
Width/number of modules	18 mm / 1	18 mm / 1	18 mm / 1	18 mm / 1	27 mm / 1.5	27 mm / 1.5	36 mm / 2	36 mm / 2

Accessories

Digiware plug-in connector

With the Digiware plug-in connector you can disconnect a DIRIS Digiware module from the Bus while ensuring the DIRIS Digiware system continues to run downstream.

This accessory is particularly useful in applications with retractable drawers or critical applications such as in data centres.



diris-o_025_a.eps

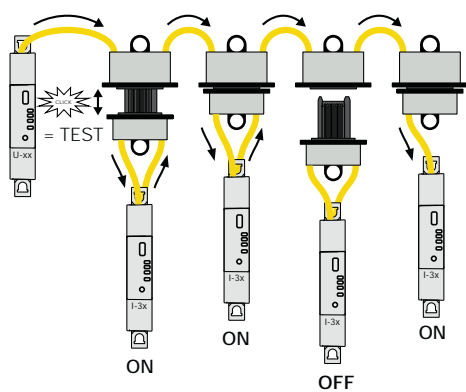

diris-o_026_a_1_cat.ai

Dimensions (mm)

DIRIS Digiware I-3x / I-6x

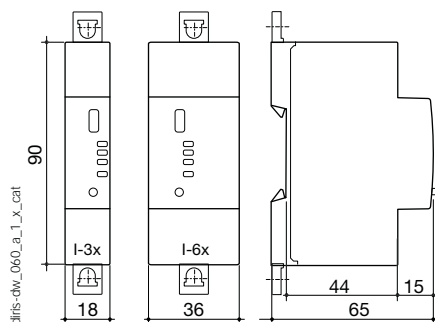

DIRIS Digiware I-4x

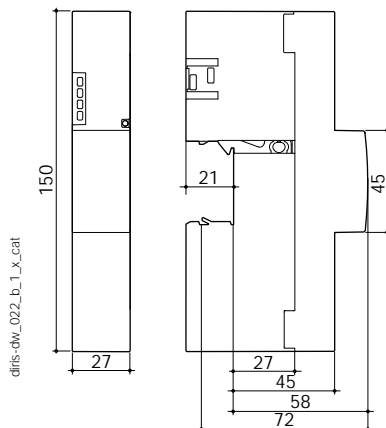

Connections

Associated current sensors

Various types of current sensors are connected to the DIRIS Digiware: closed (TE), split core (TR) or flexible (TF). This range of sensors can be adapted to all types of new or existing installations. A rapid RJ12 connection makes wiring easy and reliable and prevents wiring errors. The DIRIS Digiware system automatically recognises the sensor size and type. This guarantees the overall accuracy of the DIRIS Digiware + current sensor measurement chain.

For more information: see page 46.

Network and connection examples

I3x

Three-phase

3P - 3CT (1 three-phase load)

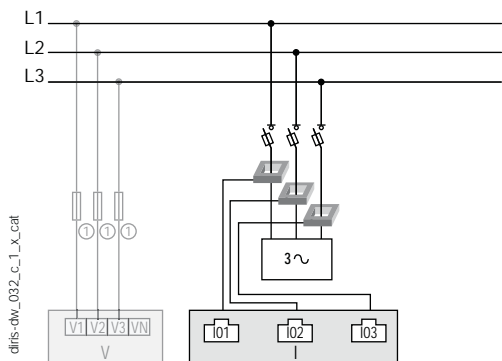

Three-phase

3P - 1CT (3 balanced, three-phase loads)

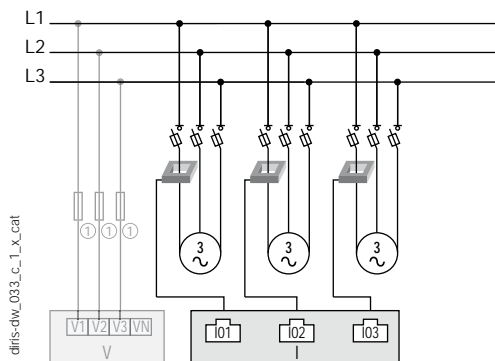

I4x

Three phase + neutral

3P+N - 4CT (1 three-phase load + Neutral measured)

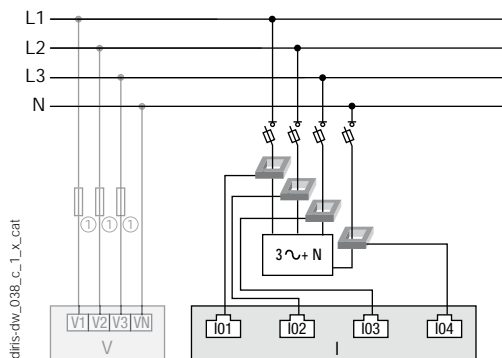

1. 0.5 A gG / 0.5 A class CC fuses.

Single-phase

1P+N-1CT (4 single-phase loads)

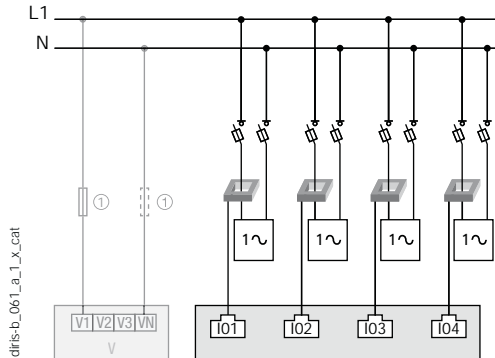

CT: Current sensor 3~ Load

Specifications

Measuring characteristics

Current measurement - DIRIS Digiware I	
Number of current inputs	I-3x: 3 / I-45: 4 / I-6x: 6
Associated current sensors	Solid TE, split-core TR, flexible TF current sensors
Accuracy of current measurement	0.2 DIRIS Digiware class only Class 0.5 with TE or TF sensors Class 1 with TR sensors
Connection	Specific Socomec cable with RJ12 connectors
Inputs - DIRIS Digiware I-45	
Number of inputs	2
Type / Power supply	Non-insulated input, internal polarisation 12 VDC max, 1mA
Input functions	Logic status, pulse meter, multi-tariff
Connection	Removable screw terminal block, stranded or solid 0.14-1.5 mm ² cable

Outputs - DIRIS Digiware I-45	
Number of outputs	2
Relay type	230 VAC ±15 % - 1 A
Function	Configurable alarm (current, power, etc.) when threshold is exceeded or remote controlled status
Connection	Removable screw terminal block, stranded or solid 0.2-2.5 mm ² cable

Communication specifications

USB	
Protocol	Modbus RTU on USB
Function	Configuration of DIRIS Digiware U and I modules
Location	On each DIRIS Digiware U and I measurement module
Connection	Type B micro USB connector

References

DIRIS Digiware	Reference
I-30 Metering - 3 current inputs	4829 0110
I-31 Metering + load curve - 3 current inputs	4829 0111
I-33 Monitoring - 3 current inputs	4829 0128
I-35 Analysis - 3 current inputs	4829 0130
I-43 Monitoring - 2 inputs/ 2 outputs - 4 current inputs	4829 0129
I-45 Analysis - 2 inputs/ 2 outputs - 4 current inputs	4829 0131
I-60 Metering - 6 current inputs	4829 0112
I-61 Metering + load curve - 6 current inputs	4829 0113
Accessories	Reference
Digiware x 5 plug-in connector	4829 0605

Digiware connection cables	Reference	
RJ45 cables for Digiware Bus	Length 0.06 m	4829 0189
	Length 0.10 m	4829 0181
	Length 0.20 m	4829 0188
	Length 0.50 m	4829 0182
	Length 1 m	4829 0183
	Length 2 m	4829 0184
	Length 5 m	4829 0186
	Length 10 m	4829 0187
	Reel 50 m + 100 connectors	4829 0185
Digiware bus terminating resistor (supplied with C and D devices)	4829 0180	
USB configuration cable	4829 0050	

(1) DIRIS D-30 display characteristics see page 30.

Expert Services

Require integration onto your network?

No problem for our "Expert Services" team. They will fully integrate all your SOCOMEC devices, **audit** your system, **commission** selected equipment and **train** your staff on its use.

For further information, please contact your nearest SOCOMEC branch.



TE sensors

Solid current sensors

used with DIRIS Digiware, DIRIS A-40 and DIRIS B

Current sensors



TE solid sensors

Function

TE smart **current sensors** measure the load currents of an electrical system and send the data to meters and measurement hubs via an RJ12 plug-and-play output. Thanks to a wide measurement range, TE current sensors cover the full current range of 5 to 2000 A, with 7 references. TE solid current sensors can be connected to DIRIS Digiware and DIRIS B-30 via a rapid RJ12 connection.

Numerous accessories are available to aid the installation of sensors in any type of cabinet.

Advantages

Plug & Play

- A rapid RJ12 connection makes wiring easy and reliable and prevents wiring errors. This also allows automatic detection of the sensor type and size/transformation ratio.
- The sensors can be installed in both directions.

Accuracy as per standard IEC 61557-12

- Class 0.5 for the global measuring chain (measurement hub + TE current sensors) from 2 to 120% of the nominal current I_n .

Installation

- The TE solid sensor range is specially designed for new installations, and has the same pitch as the most common protective devices.

The solution for

- > Industry
- > Building
- > Infrastructure
- > Data center



Strong points

- > Plug & Play
- > Accuracy as per standard IEC 61557-12
- > Installation

Conformity to standards

- > IEC 61557-12



- > ISO 14025



- > UL



Create your project

- > Find the best DIRIS Digiware configuration:
www.meter-selector.com



Mounting

Linear assembly with the protective devices
 TE-25 / TE-35 / TE-45 / TE-55 / TE-90



DIN rail mounted



TE-90 clamps



Staggered assembly
 TE-18 / TE-35 / TE-45 / TE-55



Back-plate mounting

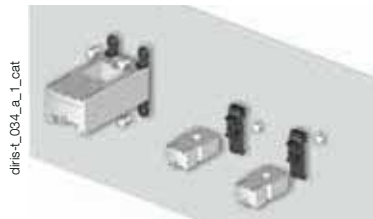

Cable mounting



Bar mounting

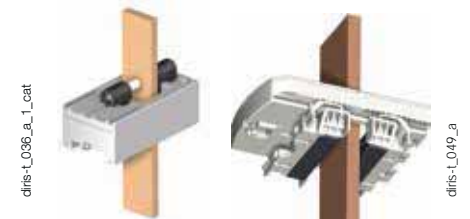



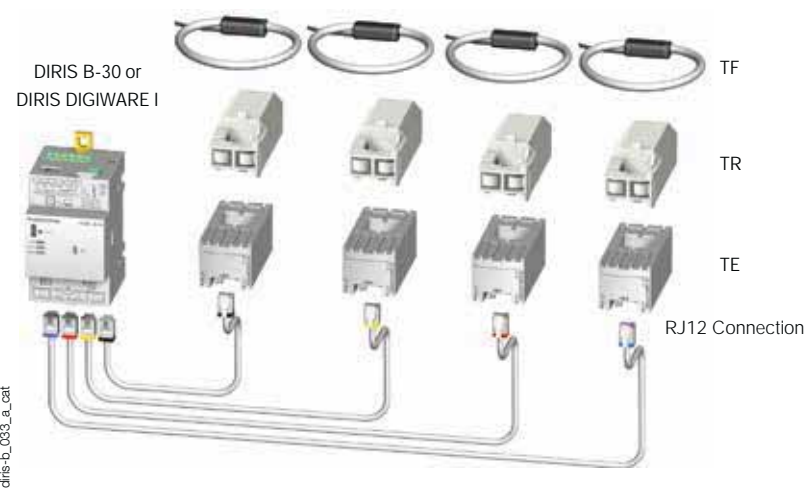

Connections

TE / TR / TF current sensors



Mounting accessories

Mounting accessories delivered with TE sensors:

Switch mounting		TE-18	TE-25	TE-35 TE-45 TE-55	TE-90
	DIN rail and back-plate	1 pc			2 pcs
	DIN rail		2 pcs	2 pcs	
	Back-plate		4 pcs	4 pcs	6 pcs
	Busbar			2 pcs	

diris-t_042_a - 043_a - 044_a - 045_a

Compatible accessories

Adapter for CT with 5A secondary

diris-t_041_a_1_cat



- With this adapter you can use a current transformer with a 5 A output on DIRIS Digiware I, DIRIS B and DIRIS A-40. For use with standard 5 A CTs for measuring applications of > 2000 A. The dimensions are the same as the TE-18.

Coupling link

diris-t_020_a_1_cat



- Associated with the TE range, this accessory is for inter-connecting the sensors when linear or staggered mounted.



Sealable cover

- Using a sealable cover guarantees the immunity of the sensor connection on TE/TR/TF current sensors.



Dimensions (mm)

TE - Solid current sensors

TE-18

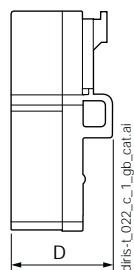
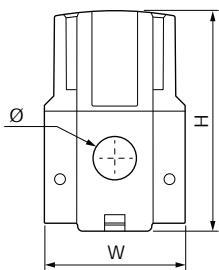

diris-t_022_c_1_gb_cat.ai

TE-25 / TE-35 / TE-45 / TE-55

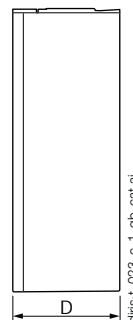
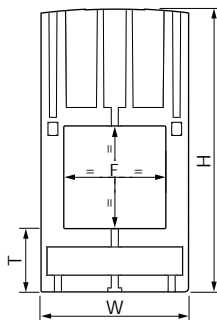

diris-t_023_c_1_gb_cat.ai

TE-90

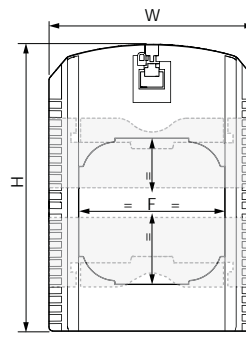

1. Switch mounting

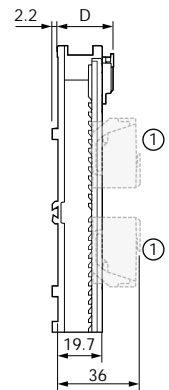

diris-t_047_b_1_gb_cat.ai

Model	Nominal current range (A)	Real range covered (A)	Pitch (mm)	H x W x D (mm)	F (mm)	T (mm)
TE-18	5 ... 20 / 25 ... 63	0.1 ... 24 / 0.5 ... 75	18	45 x 28 x 20	8.6	-
TE-25	40 ... 160	0.8 ... 192	25	65 x 25 x 32.5	13.5 x 13.5	17.5
TE-35	63 ... 250	1.26 ... 300	35	71 x 35 x 32.5	21 x 21	17.5
TE-45	160 ... 630	3.2 ... 756	45	86 x 45 x 32.5	31 x 31	19.5
TE-55	400 ... 1000	8 ... 1200	55	100 x 55 x 32.5	41 x 41	21.5
TE-90	600 ... 2000	12 ... 2400	90	126 x 90 x 24.6	64 x 64	-

Specifications

TE - Solid current sensors							
Model	TE-18	TE-18	TE-25	TE-35	TE-45	TE-55	TE-90
Nominal current range I_n (A)	5 ... 20	25 ... 63	40 ... 160	63 ... 250	160 ... 630	400 ... 1000	600 ... 2000
Real range covered (A)	0.1 ... 24	0.5 ... 75	0.8 ... 192	1.26 ... 300	3.2 ... 756	8 ... 1200	12 ... 2400
Max. current (A)	24	75.6	192	300	756	1200	2400
Weight (g)	24	24	69	89	140	187	163
Max. voltage (phase/neutral)	300 V						
Rated withstand voltage	3 kV						
Frequency	50/60 Hz						
Intermittent overload	10 x I_n over 1 sec						
Measurement category	CAT III						
Protection degree	IP30 / IK06						
Operating temperature	-10 ... +70°C						
Storage temperature	-25 ... +85°C						
Relative humidity	95% RH non-condensing						
Altitude	< 2000 m						
Connection	Socomec RJ12 cable						

References

Model	Nominal current range (A)	Real range covered (A)	Pitch (mm)	Reference
TE-18	5 ... 20	0.1 ... 24	18	4829 0500
TE-18	25 ... 63	0.5 ... 75	18	4829 0501
TE-25	40 ... 160	0.8 ... 192	25	4829 0502
TE-35	63 ... 250	1.26 ... 300	35	4829 0503
TE-45	160 ... 630	3.2 ... 756	45	4829 0504
TE-55	400 ... 1000	8 ... 1200	55	4829 0505
TE-90	600 ... 2000	12 ... 2400	90	4829 0506

Accessories	Reference
Coupling link (20 linear assembly parts and 10 for staggered assembly)	4829 0598
5 A CT adapter (measurements of >2000 A) (max primary current 10000 A for 5 A CT)	4829 0599
Sealable caps (20 pieces)	4829 0600

RJ12 connection cables	Cable length (m)								
	0.1	0.2	0.3	0.5	1	2	5	10	50 m reel + 100 connectors
Number of cables	Reference	Reference	Reference	Reference	Reference	Reference	Reference	Reference	Reference
1	-	-	-	-	-	-	4829 0602	4829 0603	4829 0601
3	4829 0580	4829 0581	4829 0582	4829 0595	4829 0583	4829 0584	-	-	-
4	-	-	-	4829 0596	4829 0588	4829 0589	-	-	-
6	4829 0590	4829 0591	4829 0592	4829 0597	4829 0593	4829 0594	-	-	-



TR/iTR sensors

Split-core AC current sensors

used with DIRIS Digiware, DIRIS A-40 and DIRIS B

Current sensors



TR Split-core current sensors

Function

The **split-core current sensors** in the TR and iTR ranges enable the current of an electrical installation to be measured. Used with power monitoring device DIRIS Digiware, DIRIS A-40, DIRIS B, they make it possible to perform measurements between 25 and 600 A, with guaranteed accuracy. The RJ12 connection provides quick connections, and the integrated intelligence prevents any configuration errors.

The sensors in the iTR range revolutionise the world of measurement and provide access to VirtualMonitor status monitoring technologies and to AutoCorrect automatic configuration.

Advantages of the TR and iTR ranges

Smart sensors

- Sensors with an extended operational range.
- Automatic detection of rating.
- Secured disconnection of load.
- Quick connection via RJ12 and identification of cable by colour code.

Accurate

- Measurement precision guaranteed in acc. with standard IEC 61557-12 : class 0.5 (iTR) or 1 (TR) for the global measuring chain from 2 to 120% of I_n .

Unique advantages of the iTR range

VirtualMonitor technology

VirtualMonitor provides monitoring of protective devices:

- Across the entire electrical installation.
- Remotely and in real-time.
- Without additional hardware or wiring (no auxiliary contacts needed).

AutoCorrect technology

AutoCorrect guarantees that your measurement system is working correctly:

- Automatic wiring control (current voltage phase association).
- Correction of errors.
- Feature available off load.

The solution for

- > Retrofit applications
- > Industry
- > Building
- > Infrastructure
- > Data centers



Strong points

- > Smart sensors
- > PreciSense technology: Accurate.
- > Easy installation and configuration.

Integrated technologies⁽¹⁾



⁽¹⁾ AutoCorrect and VirtualMonitor are only available with iTR sensors.

For more information see our website www.socomec.com

Compliance with standards

- > IEC 61557-12



- > ISO 14025



- > UL



Create your project

- > Find the best DIRIS Digiware configuration: www.meter-selector.com



Installation

Cable mounting



Dimensions (mm)

TR-10 / TR-14 / TR-21 / TR-32

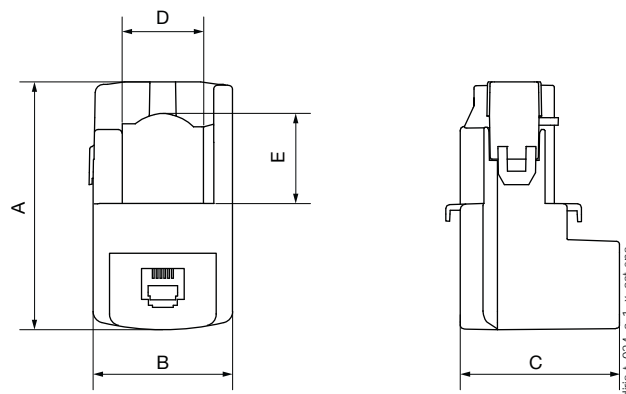

Model	Nominal current range (A)	Real range covered (A)	A (mm)	B (mm)	C (mm)	D (mm)	E (mm)	Ø (mm)
TR/iTR-10	25 ... 63	0.5 ... 75.6	44	26	28	-	-	10
TR/iTR-14	40 ... 160	0.8 ... 192	67	29	28	14	15	14
TR/iTR-21	63 ... 250	1.26 ... 300	65	37	43	21	23	21
TR/iTR-32	160 ... 600	3.2 ... 720	86	53	47	32	33	32

Technical characteristics

Model	TR-10	iTR-10	TR-14	iTR-14	TR-21	iTR-21	TR-32	iTR-32
Nominal current range I_n (A)	25 ... 63		40 ... 160		63 ... 250		160 ... 600	
Real range covered (A)	0.5 ... 75.6		0.8 ... 192		1.26 ... 300		3.2 ... 720	
Max. current (A)	75.6		192		300		720	
Weight (g)	74		117		211		311	
Max. voltage (phase/neutral)	300 V							
Rated withstand voltage	3 kV							
Frequency	50/60 Hz							
Intermittent overload	10 x I_n for 1 s							
Measurement category	CAT III							
Global class used with Diris Digiware/A-40/B-10/B-30	Class 1	Class 0.5	Class 1	Class 0.5	Class 1	Class 0.5	Class 1	Class 0.5
Protection degree	IP20 / IK07							
Operating temperature range	-10 to +70°C						-10°...+55°C	
Storage temperature range	-25 to +85°C							
Relative humidity	95% RH non-condensing							
Altitude	< 2000 m							
Connection	Socomec RJ12 cable							

References

Model	Nominal current range (A)	Real range covered (A)	Ø (mm)	Reference
TR-10	25 ... 63	0.5 ... 75	10	4829 0555
TR-14	40 ... 160	0.8 ... 192	14	4829 0556
TR-21	63 ... 250	1.26 ... 300	21	4829 0557
TR-32	160 ... 600	3.2 ... 720	32	4829 0558

Model	Nominal current range (A)	Real range covered (A)	Ø (mm)	Reference
iTR-10	25 ... 63	0.5 ... 75	10	4829 0655
iTR-14	40 ... 160	0.8 ... 192	14	4829 0656
iTR-21	63 ... 250	1.26 ... 300	21	4829 0657
iTR-32	160 ... 600	3.2 ... 720	32	4829 0658

RJ12 connection cables	Cable length (m)								
	0.1	0.2	0.3	0.5	1	2	5	10	50 m reel + 100 connectors
Number of cables	Reference	Reference	Reference	Reference	Reference	Reference	Reference	Reference	Reference
1	-	-	-	-	-	-	4829 0602	4829 0603	4829 0601
3	4829 0580	4829 0581	4829 0582	4829 0595	4829 0583	4829 0584	-	-	-
4	-	-	-	4829 0596	4829 0588	4829 0589	-	-	-
6	4829 0590	4829 0591	4829 0592	4829 0597	4829 0593	4829 0594	-	-	-



TF sensors

Flexible TF current sensors

used with DIRIS Digiware, DIRIS A-40 and DIRIS B

Current sensors



TF Flexible current sensors

diris-L077.eps

The solution for

- > Industry
- > Building
- > Infrastructure
- > Data centers



Strong points

- > Plug & Play
- > Accuracy according to IEC 61557-12
- > Installation
- > Simplified installation

Integrated technologies



PreciSense

For more information see our website www.socomec.com

Compliance with standards

- > IEC 61557-12



- > ISO 14025



- > UL



Create your project

- > Find the best DIRIS Digiware configuration: www.meter-selector.com



Function

TF flexible **current sensors** measure the load currents of an electrical circuit and send the data to meters and Power Monitoring Devices or current modules via an RJ12 plug-and-play connection. Thanks to a wide measurement range, TF current sensors cover a wide current range from 150 to 6000 A, with only 5 references. TF flexible current sensors can be used with DIRIS Digiware I modules, DIRIS A-40 and DIRIS B.

Advantages

Plug & Play

- A rapid RJ12 connection makes wiring easy and reliable and prevents wiring errors. This also allows automatic detection of the sensor type and rating.
- The sensors can be installed in both directions.

Accuracy according to IEC 61557-12

- Class 0.5 for the global measuring chain (PMD + TF current sensors) from 2 to 120% of the nominal current I_n .
- Accuracy is guaranteed regardless of the position of the conductor in the loop.

Safe locking mechanism

- The locking system prevents the loop from opening, guaranteeing continuous functioning and accuracy even under harsh conditions.

Installation

- The TF flexible sensor range is specially designed for existing installations with strict integration constraints or with high-intensity currents.

Simplified installation

- The Rogowski integrator is directly integrated to the RJ12 cable enabling a quick and compact integration (no DIN rail assembly required) inside electrical panels.
- The integrator is self supplied by the PMD through the RJ12 cable and does not need any external power supply.

Installation

Cable mounting



diris-L_079.psd

Bar mounting

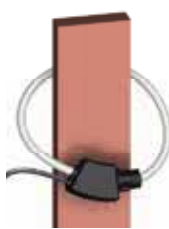

diris-L_080.psd

Dimensions (mm)

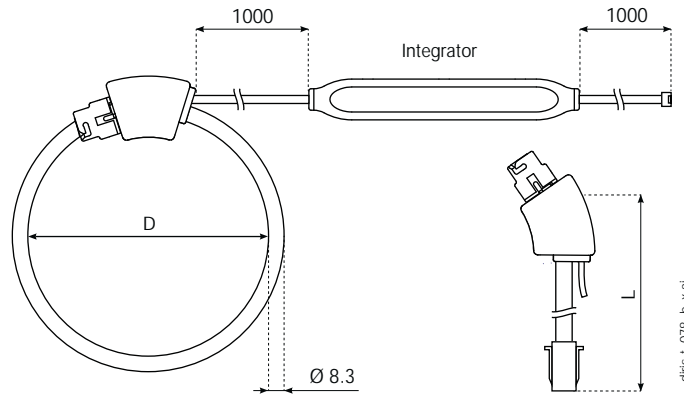

Model	Nominal current range (A)	Real range covered (A)	D = Ø loop (mm)	L = Loop length (mm)
TF-55	150 ... 600	3 ... 720	55	173
TF-80	150 ... 600	3 ... 720	80	251
TF-120	400 ... 2000	8 ... 2400	120	377
TF-200	600 ... 4000	12 ... 4800	200	628
TF-300	1600 ... 6000	32 ... 7200	300	942
TF-600	1600 ... 6000	32 ... 7200	600	1885

Integrator dimensions: 128 x 19 x 15 mm

Technical characteristics

Model	TF-55	TF-80	TF-120	TF-200	TF-300	TF-600
Nominal current range I_n (A)	150 ... 600	150 ... 600	400 ... 2000	600 ... 4000	1600 ... 6000	1600 ... 6000
Real range covered (A)	3 ... 720	3 ... 720	8 ... 2400	12 ... 4800	32 ... 7200	32 ... 7200
Weight (g)	114	130	142	164	193	274
Max. voltage (phase/neutral)	600 V					
Rated withstand voltage	3.6 kV					
Accuracy class	0.5 in association with DIRIS Digiware I, DIRIS A-40, DIRIS B based on IEC 61557-12					
Frequency	50 / 60 Hz					
Intermittent overload	10 x I_n for 1 s					
Measurement category	CAT III					
Protection degree	IP30 / IK07					
Operating temperature	-10 to +70°C					
Storage temperature	-25 to +85°C					
Relative humidity	95% RH non-condensing					
Altitude	< 2000 m					
Connection	Socomec cable or equivalent RJ12 straight, twisted pair, unshielded, 600 V, -10 ... +70 °C					

References

Model	Nominal current range (A)	Real range covered (A)	D = Ø loop (mm)	L = Loop length (mm)	Reference
TF-55	150 ... 600	3 ... 720	55	173	4829 0570
TF-80	150 ... 600	3 ... 720	80	251	4829 0574
TF-120	400 ... 2000	8 ... 2400	120	377	4829 0575
TF-200	600 ... 4000	12 ... 4800	200	628	4829 0576
TF-300	1600 ... 6000	32 ... 7200	300	942	4829 0577
TF-600	1600 ... 6000	32 ... 7200	600	1885	4829 0578
Accessories					Reference
Female/female connector for extension of the RJ12 connection between PMD and TF sensor.					4829 0670

RJ12 connection cables	Cable length (m)								
	0.1	0.2	0.3	0.5	1	2	5	10	50 m reel + 100 connectors
Number of cables	Reference	Reference	Reference	Reference	Reference	Reference	Reference	Reference	Reference
1							4829 0602	4829 0603	4829 0601
3	4829 0580	4829 0581	4829 0582	4829 0595	4829 0583	4829 0584			
4				4829 0596	4829 0588	4829 0589			
6	4829 0590	4829 0591	4829 0592	4829 0597	4829 0593	4829 0594			



DIRIS Digiware Udc

DC voltage acquisition module

Multi-circuit metering & measurement



DIRIS Digiware U-31dc/U-32dc



DIRIS Digiware U500dc/U1000dc/U1500dc adaptor



Configuration with EasyConfig, see page 160.

Function

The **DIRIS Digiware U-3xdc** module measures DC voltage for the entire system. It measures up to 180 VDC with a direct connection and is therefore compatible with typical nominal voltages (24 VDC, 48 VDC...).

The voltage adaptors make the system compatible with all voltage levels up to 1650 VDC to respond to the needs of all applications.

The RJ45 Digiware Bus transmits voltage measurements along with power supply and communication to all connected products.

Advantages

Single voltage measurement

- 1 single voltage measurement point for the entire system.
- Single point of protection for the voltage measurement.
- No hazardous voltage on panel doors.

Flexible

- The voltage adaptors make the measurement system compatible with all DC electrical networks.

Plug & Play

- Easy to configure from DIRIS Digiware D interfaces or from the Easy Config configuration software.

The solution for

- > Data centre
- > Telecommunication
- > Renewable power
- > Transportation



Strong points

- > Centralisation of voltage measurement
- > Flexible
- > Plug & Play



RJ45 (Digiware Bus) cables are available.

Compliance with standards

- > IEC 61557-12







- > ISO 14025



- > UL E257746



Application	DC voltage measurement	
		
DIRIS Digiware Udc	U-31dc	U-32dc
Nominal voltage range	24 ... 48 VDC	60 ... 150 VDC
Measuring range (min-max)	19.2 ... 60 VDC	48 ... 180 VDC
Multi-measurement		
DC voltage (VDC)	•	•
Power quality		
V ripple (voltage ripple)	•	•
V _{rms}	•	•
Alarms		
Thresholds and combinations	•	•
Trends		
Average values	•	•
Format		
Width/number of modules	18 mm / 1	

Application	DC voltage adaptors		
			
DIRIS Digiware Udc	U500dc	U1000dc	U1500dc
Max. voltage range	200 ... 600 VDC	400 ... 1200 VDC	1200 ... 1650 VDC
Association			
U-32dc	•	•	•
Format			
Width/number of modules	54 mm / 3		

Connections

Connecting DIRIS Digiware DC adaptors

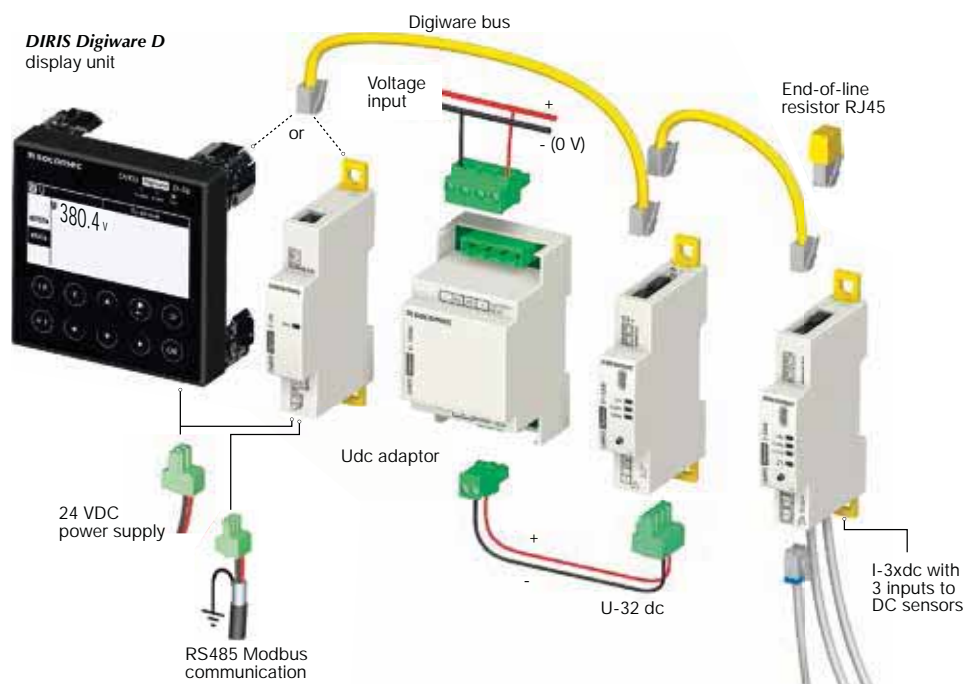

diris-dw_132_a_en.ai

Dimensions (mm)

DIRIS Digiware U-3xdc

DIRIS Digiware adaptors
U500dc/U1000dc/U1500dc

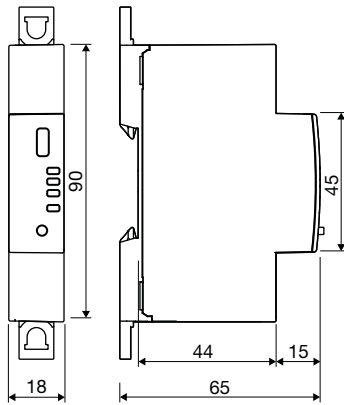

diris-dw_106_a_1_cat

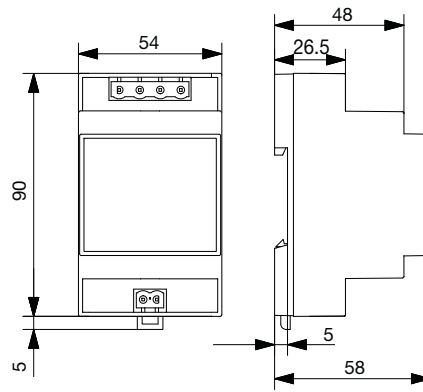

diris-dw_115_a_1_x_cat

Technical characteristics

Measurement characteristics

DC voltage measurement - DIRIS Digiware U	
Features of the network measured (min-max)	Without adaptors: U-31dc : 19.2 - 60 VDC U-32dc : 48 - 180 VDC With adaptor: U-32dc + adaptor U500dc : 200 - 600 VDC U-32dc + adaptor U1000dc : 400 - 1200 VDC U-32dc + adaptor U1500dc : 1200 - 1650 VDC
Voltage measurement accuracy without adaptor	Class 0.5 IEC 61557-12
Voltage measurement accuracy with adaptor	Class 1 IEC 61557-12
Connection without adaptor	Removable screw terminal block, 2 positions, stranded or solid 0.2 - 2.5 mm ² cable
Connection with adaptor	Adaptor input: removable screw terminal block, 2 positions, stranded or solid 0.2 ... 2.5 mm ² cable Adaptor output: removable screw terminal block, 2 positions, stranded or solid 0.2 ... 2.5 mm ² cable
Module power consumption	0.6 VA

Mechanical features

Casing type	DIN-rail mounting module and base
Casing protection index	IP20 / IK06
Front panel protection index	IP40 front face in modular assembly / IK06
Weight	64 g

Environmental specifications

Ambient operating temperature	-10 to +70 °C
Storage temperature	-25 to +70 °C
Operating humidity	55 °C / 97% HR
Operating altitude	< 2000 m

Communication specifications

USB	
Protocol	Modbus RTU on USB
Function	Configuration of DIRIS Digiware modules
Location	On each DIRIS Digiware measurement module
Connection	Type B micro USB connector
Digiware bus	
Function	Connection between DIRIS Digiware modules
Cable type	Specific Socomec cable with RJ45 connections

References

Digiware connection cables		Reference	DIRIS Digiware		Reference
RJ45 cables for Digiware Bus	Length 0.06 m	4829 0189	U-31dc	Voltage measurement 19.2 ... 60 VDC	4829 0150
	Length 0.10 m	4829 0181	U-32dc	Voltage measurement 48 ... 180 VDC	4829 0151
	Length 0.20 m	4829 0188	U500dc	Voltage adaptor 200 ... 600 VDC	4829 0153
	Length 0.50 m	4829 0182	U1000dc	Voltage adaptor 400 ... 1200 VDC	4829 0154
	Length 1 m	4829 0183	U1500dc	Voltage adaptor 1200 ... 1650 VDC	4829 0155
	Length 2 m	4829 0184			
	Length 5 m	4829 0186			
	Length 10 m	4829 0187			
	50 m reel + 100 connectors	4829 0185			
Termination for Digiware Bus (supplied with interfaces C and D)		4829 0180			
USB configuration cable		4829 0050			



DIRIS Digiware Idc

Direct current acquisition module

Multi-circuit metering & measurement



diris-dw_095_b_eps

DIRIS Digiware I-30dc/I-35dc



Configuration with EasyConfig, see page 160.

Function

DIRIS Digiware Idc modules measure consumption and monitor the DC electrical installation. Several Idc modules can be used within the same system, allowing the measurement of a large number of DC circuits. They are associated with DIRIS Digiware Udc voltage measurement modules.

Direct current is measured using external sensors connected by RJ12-Molex cables, available in multiple lengths. These cables are colour coded (brown, orange, white) to easily identify circuits.

Advantages

Multi-circuit

- Measurement of up to 3 DC circuits per Idc module.
- Multiple Idc modules can be included. This allows the measurement of a large number of DC loads simultaneously.

Flexible

- Adapted to suit metering and quality analysis of the direct current.
- A complete range of solid core and split core DC current sensors from 50 to 5000 A.

The associated DIRIS Digiware D screen and the embedded webserver Webview can display electrical measurements from both DIRIS Digiware AC and DC systems simultaneously.

Plug & Play

- Quick RJ45 connection between modules and RJ12-Molex to current sensors.
- Easy to configure from DIRIS Digiware D interfaces or from the Easy Config software.

Compact

One module wide to address space constraints inside electrical panels.

The solution for

- > Data centre
- > Telecommunication
- > Renewable power
- > Transportation



Strong points

- > Multi-circuit
- > Plug & Play
- > Flexible
- > Compact



RJ45 (Digiware Bus) cables are available.

Compliance with standards

- > IEC 61557-12





- > ISO 14025



- > UL E257746



Application	Direct current (DC) measurement modules	
		
DIRIS Digiware Idc	I-30dc	I-35dc
Number of current inputs	3	3
Metering		
± kWh	•	•
Load curves		•
Multi-measurement		
DC current (I DC)	•	•
DC power (P DC)	•	•
Predictive power		•
Measurement of current quality		
I ripple (current ripple)		•
I rms		•
Alarms		
Thresholds and combinations		•
Trends		
Average values		•
Format		
Width/number of modules	18 mm / 1	

Dimensions (mm)

DIRIS Digiware Idc

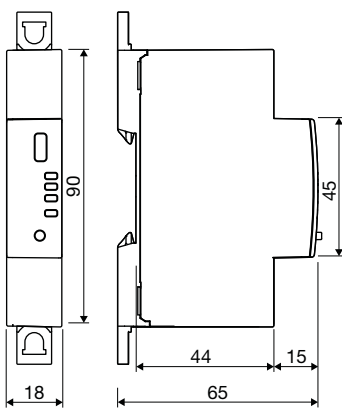

diris-dw_106_a_1_cat

Connections

DC current is measured by external sensors connected to the DIRIS Digiware I-3xdc modules via RJ12-Molex cables. Connection of the current sensors is quick and error-free. A wide range of current sensors is available from Socomec to suit all installations and applications including split-core current sensors for retrofit applications.

- Open-loop Hall effect sensors
- Solid core or split core.
- Power supply voltage: ± 15 V.
- Power supply current: ± 25 mA depending on sensor.
- Output voltage: ± 4 V.
- 4-point male Molex terminal strip.
- Measuring range: 16 to 6000 A.
- Category III overvoltage.

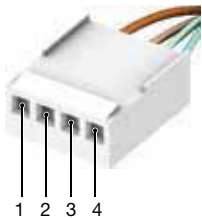
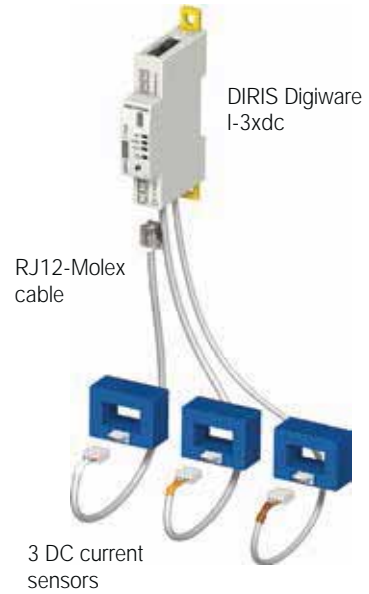

- PIN 1: + 15 V (+ Vc)
- PIN 2: - 15 V (- Vc)
- PIN 3: sensor input (M)
- PIN 4: 0 V sensor (0)

Network and connection examples

Measurement of 3 DC loads

DIRIS Digiware U-31dc
Voltage (VDC): 19 - 60 V

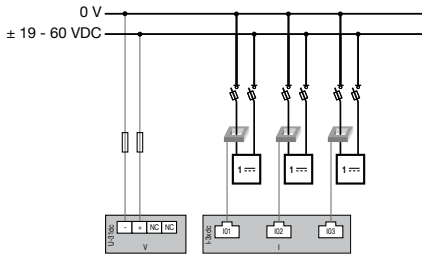

DIRIS Digiware U-32dc
Voltage (VDC): 48 - 180 V

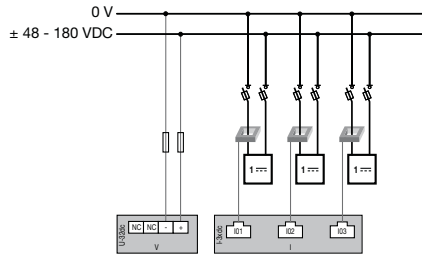

DIRIS Digiware U-32dc + adaptor U500dc
Voltage (VDC): 200 - 600 V

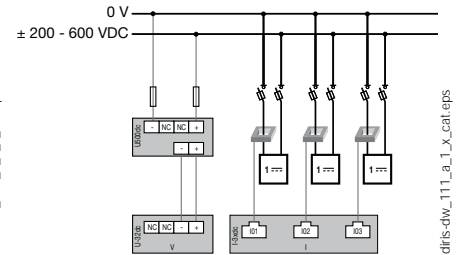

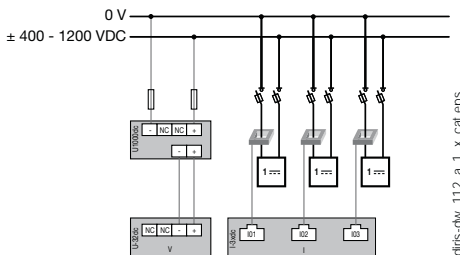

DIRIS Digiware U-32dc + adaptor U1000dc
Voltage (VDC): 400 - 1200 V

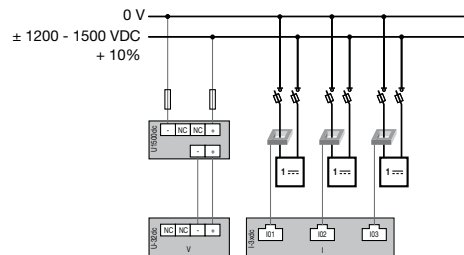

DIRIS Digiware U-32dc + adaptor U1500dc
VDC voltage: 1200 - 1500 V +10%



1. Fuse: 2A gPV  DC current sensor  DC load

Technical characteristics

Measurement characteristics

DC current measurement - DIRIS Digiware Idc	
Number of current inputs	3
Associated current sensors	Open-loop Hall effect
Accuracy of current measurement	Class 0.5
Precision measurement of power and energy	With U-31dc/U-32dc only: class 1 With U-32dc + adaptor: class 2
Connection	Specific Socomec cable with RJ12-Molex connectors
Power consumption of module	2 VA

Mechanical features

Casing type	DIN-rail mounting module and base
Casing protection index	IP20 / IK06
Front panel protection index	IP40 front face in modular assembly / IK06
Weight	69 g

Environmental specifications

Ambient operating temperature	-10 to +70 °C
Storage temperature	-25 to +70 °C
Operating humidity	55 °C / 97% HR
Operating altitude	< 2000 m

Communication specifications

USB	
Protocol	Modbus RTU on USB
Function	Configuration of DIRIS Digiware U and I modules
Location	On each DIRIS Digiware U and I measurement module
Connection	Type B micro USB connector
Digiware bus	
Function	Connection between DIRIS Digiware modules
Cable type	Specific Socomec cable with RJ45 connections

References

DIRIS Digiware I-3xdc		Reference
I-30dc	Metering - 3 current inputs	4829 0156
I-35dc	Analysis - 3 current inputs	4829 0157
RJ12-Molex cables		
Number of cables	Length of cables	Reference
3	0.3 m	4829 0782
3	0.5 m	4829 0783
3	1 m	4829 0784
3	2 m	4829 0785
1	5 m	4829 0786

Digiware connection cables		Reference
RJ45 cables for Digiware Bus	Length 0.06 m	4829 0189
	Length 0.10 m	4829 0181
	Length 0.20 m	4829 0188
	Length 0.50 m	4829 0182
	Length 1 m	4829 0183
	Length 2 m	4829 0184
	Length 5 m	4829 0186
	Length 10 m	4829 0187
50 m reel + 100 connectors		4829 0185
Termination for Digiware Bus (supplied with interfaces C and D)		4829 0180
USB configuration cable		4829 0050

Expert Services

Do you require services for your metering system?

No problem for our "Expert Services" team. They will fully integrate all your Socomec devices, **audit** your system, **commission** selected equipment and **train** your staff on its use.

For further information, please contact your nearest Socomec branch.



DC current sensors

Associated with DIRIS Digiware DC

Current sensors



tore_072_a.eps

Solid-core sensors 50 ... 600 A



tore_104_a_OPEN_FRONTeps

Split-core sensors 50 ... 500 A



tore_068_a.eps

Solid-core sensors 850 ... 5000 A



tore_066_a.eps

Split-core sensors 800 ... 2000 A

The solution for

- > Data centre
- > Telecommunication
- > Renewable power
- > Transportation



Strong points

- > Plug & Play
- > Wide selection of ratings
- > Simplified installation

Compliance with standards

- > IEC 61010-1



- > UL



Function

The **DC current sensors** measure the DC load currents of an electrical installation and transmit information to the DIRIS Digiware Idc measurement modules via an RJ12 to Molex cable on the sensor side.

The range comprises solid-core and split-core sensors ranging from 50 to 5000 A in various sizes allowing them to be used in new or existing electrical installations.

Up to 3 different DC sensors can be connected to the same DIRIS Digiware Idc module.

Advantages

Plug & Play

- A quick RJ12 connection makes wiring easy and reliable.
- Fast configuration of the sensor's rating.

Flexible

- A complete range of solid-core and split-core sensors from 50 to 5000 A designed for new or existing electrical installations.

Installation

- Easy to install.
- Ideal for installations with limited space available.
- Only 4 different frame sizes cover a wide measurement range.
- Colour-coded cables for ease of identification, and to prevent wiring errors.

Dimensions (mm)

Solid-core sensors 50 ... 600 A (frame size 1)

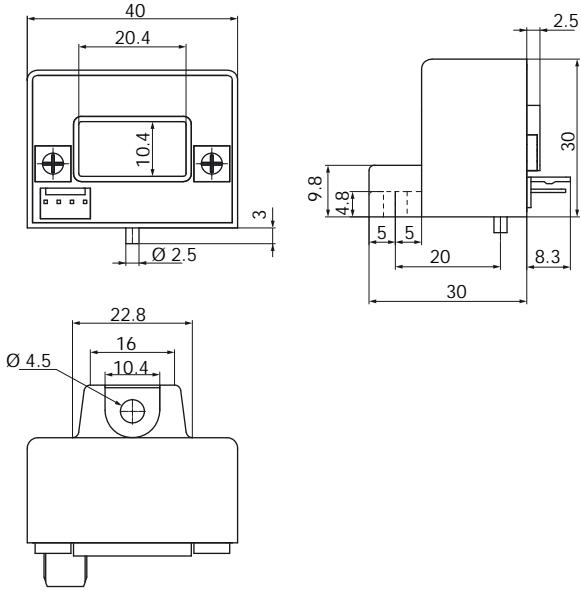

Solid-core sensors 850 ... 5000 A (frame size 2)

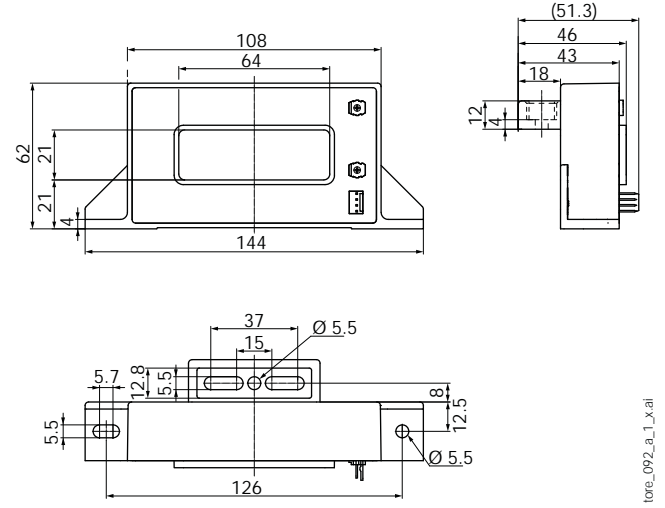

Split-core sensors 50 ... 500 A (frame size 1)

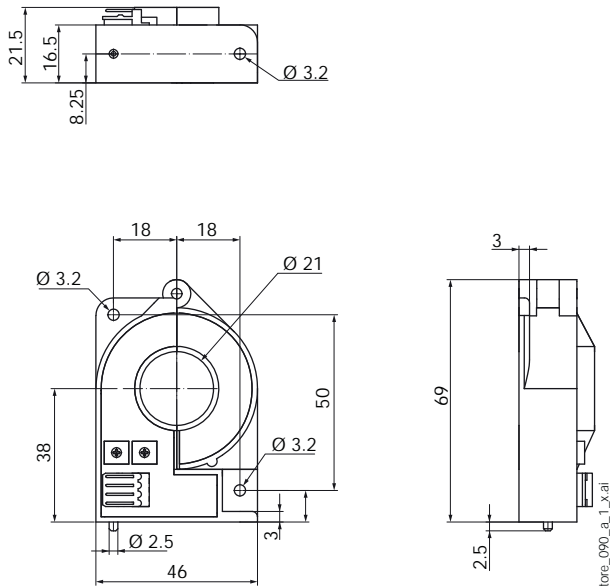

Split-core sensors 800 ... 2000 A (frame size 2)

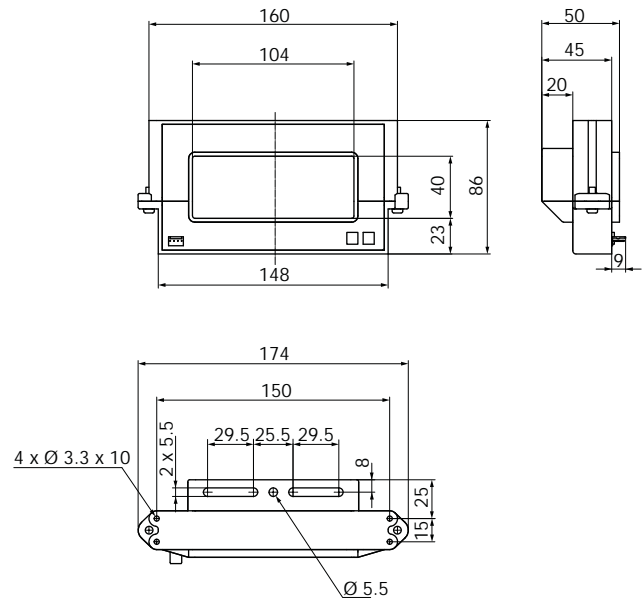

DC current sensors

Associated with DIRIS Digiware DC

Connections

DC current is measured by external sensors connected to the DIRIS Digiware I-3xdc modules via RJ12-Molex cables. Connection of the current sensors is quick and error-free. A wide range of current sensors is available from Socomec to suit all installations and applications including split-core current sensors for retrofit applications.

The DC current sensors have the following technical characteristics:

- Open-loop Hall effect sensors
- Solid-core or split-core.
- Power supply voltage: ± 15 V.
- Power supply current: ± 25 mA depending on the sensor.
- Output voltage: ± 4 V.
- 4-point male Molex terminal strip.
- Measurement range: 16 to 6000 A.
- Category III overvoltage.

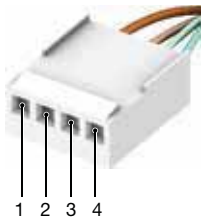

- PIN 1: + 15 V (+ Vc)
- PIN 2: - 15 V (- Vc)
- PIN 3: sensor input (M)
- PIN 4: 0 V sensor (0)

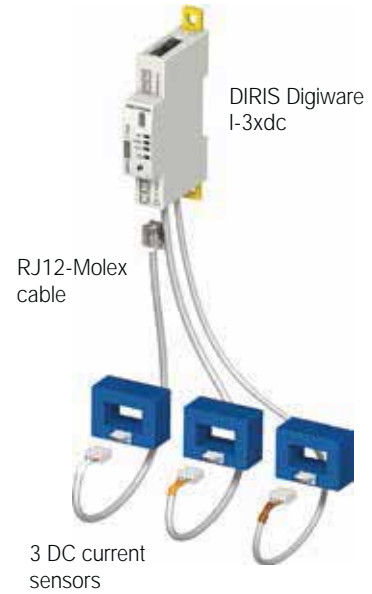

Technical characteristics

Type of current sensor	Open-loop Hall effect
Connection	Specific Socomec cable with RJ12-Molex connectors
Accuracy of current measurement	Solid-core sensors: 50 ... 600 A: < 1% Solid-core sensors: 850 ... 5000 A: < 1% Split-core sensors: 50 ... 500 A: < 2% Split-core sensors: 800 ... 2000 A: < 2%

Weight	Solid-core sensors 50 ... 600 A	60 g
	Solid-core sensors 850 ... 5000 A	450 g
	Split-core sensors 50 ... 500 A	80 g
	Split-core sensors 800 ... 2000 A	590 g
Operating temperature	Solid-core sensors 50 ... 600 A	-10 ... +80°C
	Solid-core sensors 850 ... 5000 A	-25 ... +85°C
	Split-core sensors 50 ... 500 A	-10 ... +70°C
	Split-core sensors 800 ... 2000 A	-10 ... +70°C
Storage temperature	Solid-core sensors 50 ... 600 A	-25 ... +80°C
	Solid-core sensors 850 ... 5000 A	-25 ... +85°C
	Split-core sensors 50 ... 500 A	-20 ... +85°C
	Split-core sensors 800 ... 2000 A	-25 ... +85°C

References

DC current sensors	Reference
Solid-core sensors (frame size 1)	
50 A	4829 0700
100 A	4829 0701
200 A	4829 0702
300 A	4829 0703
400 A	4829 0704
500 A	4829 0705
600 A	4829 0706
Solid-core sensors (frame size 2)	
850 A	4829 0707
1000 A	4829 0708
1500 A	4829 0709
2000 A	4829 0710
2500 A	4829 0711
5000 A	4829 0712
Split-core sensors (frame size 1)	
50 A	4829 0750
100 A	4829 0751
200 A	4829 0752
300 A	4829 0753
400 A	4829 0754
500 A	4829 0755
Split-core sensors (frame size 2)	
800 A	4829 0756
1000 A	4829 0757
1500 A	4829 0758
2000 A	4829 0759

RJ12-MOLEX cables		
Number of cables	Length of cables	Reference
3	0.3 m	4829 0782
3	0.5 m	4829 0783
3	1 m	4829 0784
3	2 m	4829 0785
1	5 m	4829 0786



Multi-circuit metering & measurement

DIRIS Digiware IO

Digital and analogue input/output modules



DIRIS Digiware IO-10
4 digital inputs/2 digital outputs

DIRIS Digiware IO-20
2 analogue inputs



Configuration with EasyConfig, see page 160.

Function

DIRIS Digiware IO modules enrich the measurement system with multiple features:

- DIRIS Digiware IO-10 modules have 4 digital inputs and 2 digital outputs.

The 4 digital inputs can be used to monitor the status of third-party devices (position of protective devices, trip counter) or to collect pulses from multi-fluid meters.

The 2 digital outputs allow the remote control of third-party equipment signal.

Alarms can be configured and assigned to the digital outputs.

- Thanks to their 2 analogue inputs, DIRIS Digiware IO-20 modules can collect data from analogue sensors (pressure, humidity, temperature...).

All the information reported by the IO-10 and IO-20 modules can be viewed on DIRIS Digiware D-xx displays and on Webview, the web server embedded in DIRIS G gateways and in the DIRIS Digiware D-70 display unit.

Advantages

Plug & Play

The IO modules can be easily added anywhere within the measurement system thanks to a quick RJ45 connection.

Multifunction

The combination of voltage measuring modules, current measuring modules, and input/output modules makes DIRIS Digiware a complete and versatile system.

Integrated

All the reported information is accessible from the displays, from WEBVIEW or any other centralised management software.

Compact

The modular format allows the quick connection of a large number of IO-10 and IO-20 modules.

The solution for

- > Industry
- > Building
- > Data center



Strong points

- > Plug & Play
- > Multifunction
- > Integrated
- > Compact

Compliance with standards

- > IEC 61557-12
- > IEC 61010



- > ISO 14025



- > UL



Create your project

- > Find the best DIRIS Digiware configuration: www.meter-selector.com



Application diagram

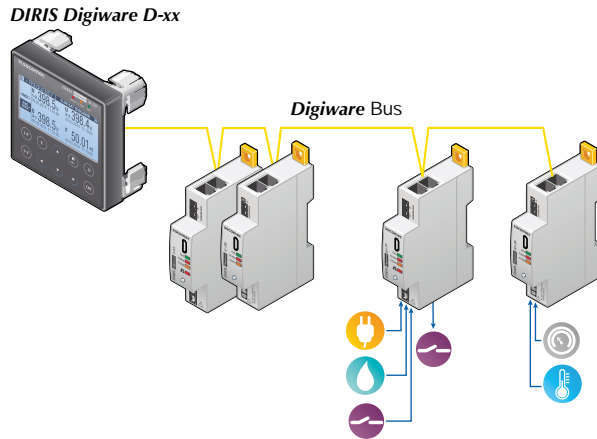

Connections

DIRIS Digiware IO-10

Digital inputs/outputs

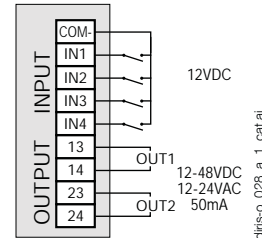

Digiware Bus

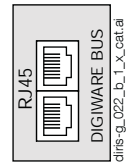

DIRIS Digiware IO-20

Analogue inputs

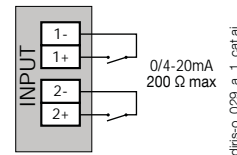

Digiware Bus

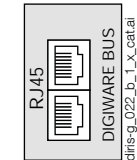

Dimensions (mm)

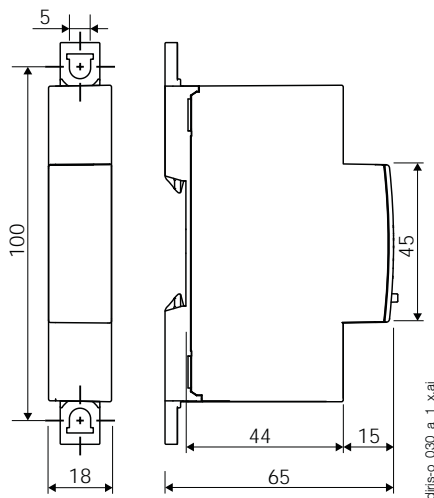

Technical characteristics

Measuring characteristics

Digital inputs/outputs- DIRIS Digiware IO-10

Number of inputs	4
Type/power supply	Insulated input, internal polarisation 12 VDC max., 3 mA
Input function	- Status of third-party devices - Monitoring of protective devices (ON/OFF, Trip) - Pulse counter
Number of outputs	2
Type	Insulated output, 48 VDC max., 50 mA and 24 VAC max.
Output function	- Remote control of devices - Alarm signal linked to the inputs (exceeding threshold, status...)
Input/output connection	Removable screw terminal block, 9 positions (5 dedicated to inputs, 4 dedicated to outputs) Stranded or solid 0.14 to 1.5 mm ² cable

Analogue inputs - DIRIS Digiware IO-20

Number of inputs	2
Type/power supply	0/4-20 mA, 200 Ω max
Accuracy	0.5% full scale
Function	Connection of analogue sensors (pressure, humidity, temperature...) with choice of interpolation (linear or quadratic)
Input connection	Removable screw terminal block 2x2 positions, Stranded or solid 0.14 to 1.5 mm ² cable

References

Digiware connection cables		Reference
RJ45 cables for Digiware Bus	Length 0.06 m	4829 0189
	Length 0.10 m	4829 0181
	Length 0.20 m	4829 0188
	Length 0.50 m	4829 0182
	Length 1 m	4829 0183
	Length 2 m	4829 0184
	Length 5 m	4829 0186
	Length 10 m	4829 0187
50 m reel + 100 connectors		4829 0185
Termination for Digiware Bus (supplied with interfaces C and D)		4829 0180
USB configuration cable		4829 0050

DIRIS Digiware input/output modules		Reference
IO-10	4 digital inputs/2 outputs module	4829 0140
IO-20	2 analogue input module	4829 0145



DIRIS Q800

Electrical network analyser

quality analysis of electrical energy and power grids

Single-circuit metering,
measurement &
analysis



DIRIS Q

diris-q_012_a

The solution for

- > Industry
- > Infrastructure
- > Healthcare buildings
- > Data centers



Strong points

- > Large colour touchscreen
- > High performance and accuracy
- > Regulatory compliance
- > Multiple communication channels

Compliance with standards

- > IEC 61000-4-30 class A
- > IEC 62586-2
- > IEC 62053-22
- > IEC 62053-24
- > EN 50160



Function

The **DIRIS Q800** is a multifunction network analyser for all energy efficiency projects. It helps to actively ensure the electrical system runs continuously and at optimised rates.

As such, with this system you can:

- Improve the efficiency of your facility.
- Reduce production losses.
- Optimise running costs.
- Reduce maintenance costs.

To achieve these objectives, the DIRIS Q800 does the following:

- Measures electrical parameters and status (via auxiliary contacts).
- Analyses the quality of energy according to class A IEC 61000-4-30.
- Measures differential current.
- GPS synchronisation.

Advantages

Large colour touchscreen

The 192 x 144 mm color touchscreen is tactile, easy to operate and provides intuitive navigation.

Regulatory compliance

By its compliance with IEC 61000-4-30 Class A and IEC 62586-2, you have the assurance of a certified and high quality product.

Multiple communication channels

With its multiple communication options, the DIRIS Q800 can be integrated into any type of communication infrastructure:

- 1 rear Ethernet port for permanent cable connection.
- 1 front Ethernet for local diagnostics.
- 1 Wifi port.
- 1 RS485 port.
- 1 USB port.
- GPS synchronisation.
- Built-in Webserver.
- Protocols: HTTP, HTTPS, FTP, NTP, MODBUS, PQDIF.

Functions

Measurements

- Measures across 4 quadrants
- Voltage by phase, current by phase, frequency.
- Neutral current, differential current.
- Neutral/earth voltage.
- Active, reactive and apparent power.
- Cos phi and power factor.
- THD and spectral analysis up to the 63rd for current and voltage.
- Flicker (Pst, Plt).
- Voltage imbalance.
- Remote control signals.

Logging

- EN 50160 events ½ period (10 ms): voltage dips, voltage interruptions, voltage swells.
- Data exported automatically via FTP.
- EN50160 compliant.
- Transients (20 micro seconds).

Inputs/outputs

- 4 digital inputs.
- 4 digital outputs.
- 4 analogue outputs.

Dimensions (mm)

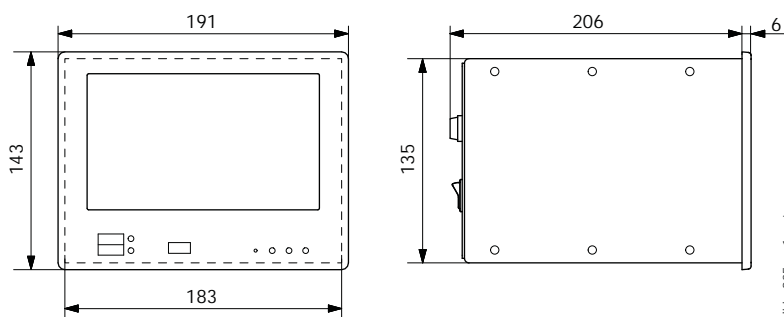

Dimensions

Cutout	192 x 144 DIN / 186 x 138 mm
Front panel (L x H)	191 x 143 mm
Enclosures (L x H x P)	183 x 135 x 190 mm
Weight	1400 g

Specifications

Auxiliary power supply	
Voltage range	100 ... 240 VAC / 65 ... 250 VDC
Frequency	50/60 Hz
Power consumption	Max. 15 VA
Backup battery	Li-ion 2500 mAh (>15 min autonomy)
Measurement inputs	
Direct voltage measurement input	P-N: max 580 V RMS CAT III L-L: max 1000 V RMS CAT III
U4 direct voltage measurement input	Max 580 V RMS CAT II
Voltage input crest factor	2
Current inputs	Max 7 A RMS
Current input consumption	0.04 VA
Current input crest factor	3
Voltage input impedance	> 6 MΩ
Frequency range	42.5 to 57.5 Hz/51 to 69 Hz
Voltage reference channel	U1N/U12
Sampling	51.2 kHz @50 Hz
Accuracy	
Three-phase voltage	± 0.1%
4 th voltage (neutral/earth)	± 0.2%
Currents	± 0.2%
Power	± 0.2%
Frequency	± 10 mHz
Harmonics	Class. 1 IEC/EN 61000-4-7
Active energy	Class. 0.5S IEC/EN 62053-22
Reactive energy	Class. 1 IEC/EN 62053-24

Communication	
Ethernet ports	2 Auto MDIX RJ45 10/100 Base Ethernet
RS485 opto-insulated port (slave)	0.5 UL 4800 to 115200 bps
Passive WIFI antenna	RP-SMA female
Active GPS antenna	SMA female
Protocols	HTTP, HTTPS, FTP, SFTP, NTP, NMEA, Modbus RTU/TCP
USB port	USB 2.0
Environmental conditions	
Operating temperature (max. range)	-25 ... +55°C
Storage temperature	-25 ... +75°C
Humidity	Max. 95 %
Max.altitude	2000 m
Standards and safety	
Product conformity	IEC/EN 62586-2
Safety	EN 61010-2-030
Degree of pollution	2 (EN 61010-1)
Degree of protection	IP40 front, IP20 rear
Directive	RED §3.1a Health EN 62311 :2008 RED § 3.1b EMC

References

Designation	Reference
DIRIS Q800	4826 0100

DIRIS Q800

Electrical network analyser

quality analysis of electrical energy and power grids

Terminals

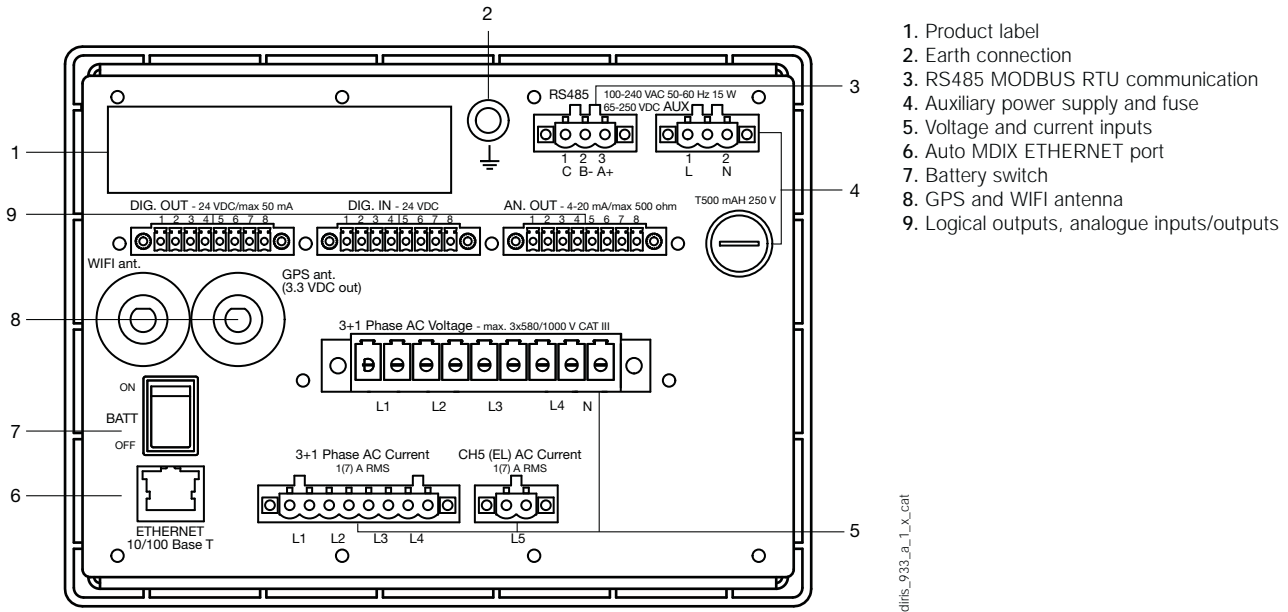

Communication via RS485 link

AC and DC auxiliary power supply

Ethernet communication

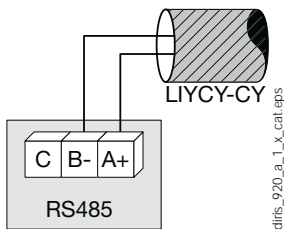

100-240 VAC
65/250 VDC

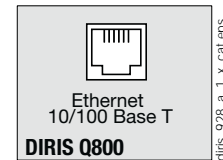
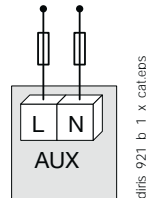

Digital outputs

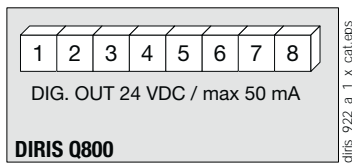

Digital inputs

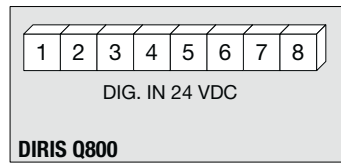

Analogue outputs

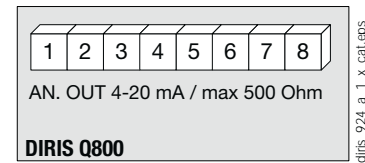

Current and voltage inputs

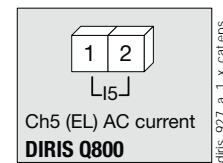
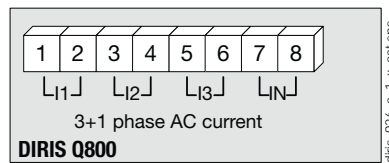
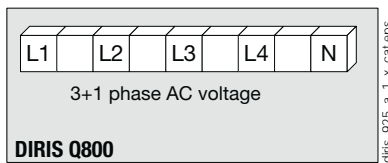

L1, L2, L3, L4, N: voltage inputs

1-2: current input i1
3-4: current input i2
5-6: current input i3
7-8: current input iN

1-2: differential core connections

Connections

4 wires with 4 CT + differential measurements (1/5 A)

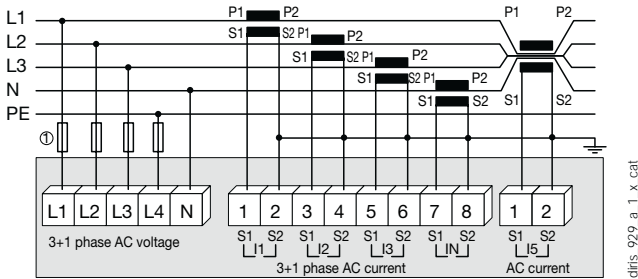

1. 0.5 A gG / 0.5 A class CC fuses.

diris_929_a_1_x_cat

3 wires with 3 CT + differential measurements (1/5 A)

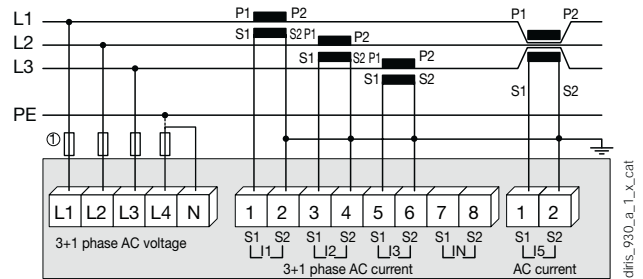

1. 0.5 A gG / 0.5 A class CC fuses.

diris_930_a_1_x_cat

3 wires with 2 CT + differential measurements

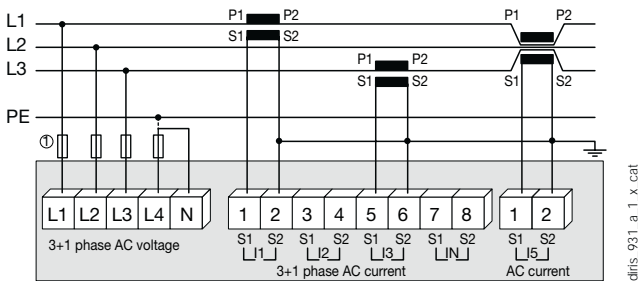

1. 0.5 A gG / 0.5 A class CC fuses.

diris_931_a_1_x_cat

Single-phase with 2 CT + differential measurements (1/5 A)

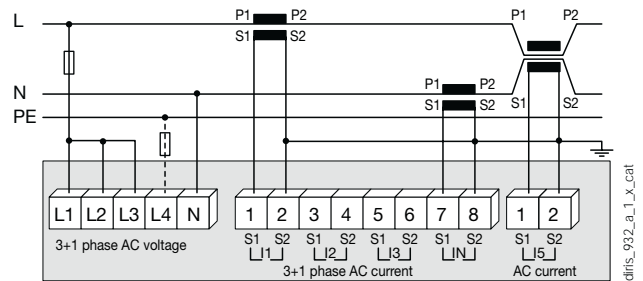

1. 0.5 A gG / 0.5 A class CC fuses.

diris_932_a_1_x_cat

Expert Services

- > Study, definition, advice, implementation, maintenance and training... Our experts "Expert Services" offer complete support for the success of your project.





MULTIS L50

Digital panel meter

three phases - via CT up to 6000 A dimensions 96 x 96 mm

Single-circuit metering,
measurement &
analysis



MULTIS L50

The solution for

- > Industry
- > Infrastructure



Strong points

- > Large backlit LCD display
- > Direct display of multimeasurement and metering values
- > RS485 MODBUS communication
- > Inputs/Output for control/command ou pulses

Conformity to standards

- > IEC 62053-21 class 1
- > IEC 62053-23 class 2



Function

The MULTIS L50 is a panel mounted digital meter displaying multi-measurement and energy values directly on its large backlit LCD display. It is designed for utilisation on three-phase or single-phase networks with connection via CT and is suitable for applications of up to 6000 A. The product can be configured by the user via the keypad and the display.

Advantages

Easy to use

Thanks to its large backlit LCD display and its multiple viewing screens with direct pushbutton access, MULTIS L50 provide clear readings and are easy to use.

They directly display a number of multi-measurement and metering values.

Advanced functionalities

The MULTIS L50 offers input/output functions as standard and has a pulse output or RS485 MODBUS communication output.

Principle diagram

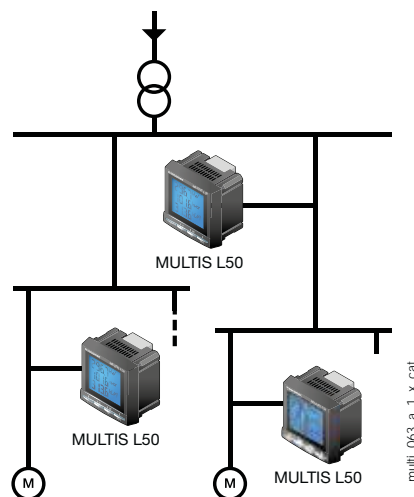

Functions

Multi-measurement

- Currents
 - instantaneous: I1, I2, I3, In
 - maximum average: I1, I2, I3, In
- Voltages & frequency
 - instantaneous: V1, V2, V3, U12, U23, U31, F
- Power
 - instantaneous: 3P, ΣP, 3Q, ΣQ, 3S, ΣS
 - maximum average: ΣP, ΣQ, ΣS
 - unbalance: U unb
- Power factors
 - instantaneous: 3PF, Σ

Metering

- Active energy: ± kWh
- Reactive energy: ± kvarh
- Hours: ⌚

Harmonic analysis

- Total harmonic distortion (level 51)
 - Currents: thd I1, thd I2, thd I3
 - Phase-to-neutral voltage: thd V1, thd V2, thd V3
 - Phase-to-phase voltage: thd U12, thd U23, thd U31

Communications⁽¹⁾

RS485 with MODBUS protocol

Output

- Remote command of device
- Pulse report

Inputs

- Remote status device

(1) Available as an option (see the following pages).

Front panel



1. Backlit LCD display.
2. Direct access key for currents (instantaneous and max. values), current THD.
3. Direct access key for voltages, frequency and voltage THD.
4. Pushbutton for active, reactive, and apparent power (instantaneous and max. values) and power factor.
5. Direct access key for energies, hour meter and programming menu.

Case

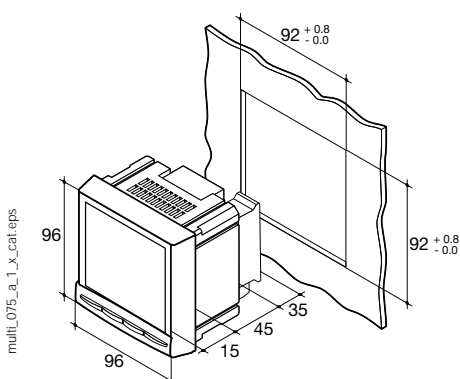

Type	panel mounting
Dimensions W x H x D	96 x 96 x 60 mm
Case degree of protection	IP30
Front degree of protection	IP52
Display type	backlit LCD display
Terminal block type	fixed or plug-in
Voltage and other connection cross-section	0.2 ... 2.5 mm ²
Current connection cross-section	0.5 ... 6 mm ²
Weight	400 g

Plug-in modules

MULTIS L50



1 Output

1 output assignable to:

- Pulses: configurable (type, weight, duration) in kWh or kvarh.
- Remote command of device.



Communication

RS485 link with JBUS / MODBUS protocol (speed up to 38400 bauds)



3 inputs, 1 output

3 inputs assignable to:

- Remote status device.

1 output assignable to:

- Pulses: configurable (type, weight, duration) in kWh or kvarh.
- Remote command of device.

Accessories

Current transformers
(see page 126)

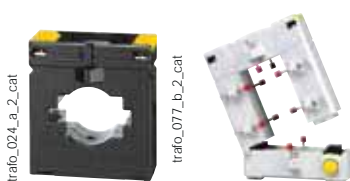

IP65 protection



Panel mounting kit
for a 144 x 96 mm cut-out



MULTIS L50

Digital panel meter

three phases - via CT up to 6000 A dimensions 96 x 96 mm

Electrical characteristics

Current measurement (TRMS)	
Via CT primary	9 999 A
Via CT secondary	5 A
Measurement range	0 ... 11 kA
Input consumption	0.6 VA
Measurement updating period	1 s
Accuracy	1%
Permanent overload	6 A
Intermittent overload	10 I _n for 1 s
Voltage measurements (TRMS)	
Direct measurement between phases	50 ... 500 VAC
Direct measurement between phase and neutral	28 ... 289 VAC
Input consumption	≤ 0.1 VA
Measurement updating period	1 s
Accuracy	1%
Permanent overload	800 VAC
Power measurement	
Measurement updating period	1 s
Accuracy	1%
Power factor measurement	
Measurement updating period	1 s
Accuracy	1%
Frequency measurement	
Measurement range	45 ... 65 Hz
Measurement updating period	1 s
Accuracy	0.1 %

Energy accuracy	
Active (according to IEC 62053-21)	Class 1
Reactive (according to IEC 62053-23)	Class 2
Auxiliary power supply	
Alternating voltage	110 ... 250 VAC
AC tolerance	± 10 %
Direct voltage	120 ... 250 VDC
DC tolerance	± 10%
Frequency	50 / 60 Hz
Consumption	10 VA
Pulse or alarm output	
Number	1
Type	100 VDC - 0.5 A - 10 VA
Max. number of operations	≤ 10 ⁸
Inputs	
Number	3
Power supply	10 ... 30 VDC
Minimum signal width	10 ms
Minimum duration between 2 pulses	18 ms
Type	Phototransistors
Communication	
Link	RS485
Type	2 ... 3 half duplex wires
Protocol	MODBUS RTU
MODBUS [®] speed	1400 ... 38400 bauds
Operating conditions	
Operating temperature	- 10 ... + 55 °C
Storage temperature	- 20 ... + 85 °C
Relative humidity	95 %

Terminals

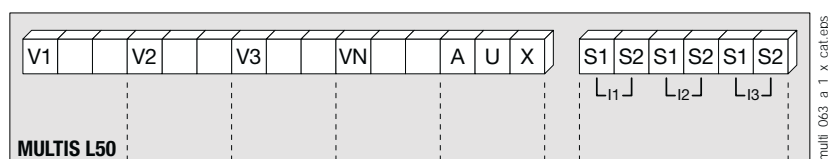

S1 - S2: current inputs.

AUX: auxiliary power supply U_s.
V1, V2, V3 & VN: voltage inputs.

Communication module

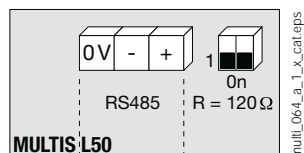

RS485 link.
R = 120 Ω: selectable internal resistance for RS485 end of line termination.

Output or alarm module

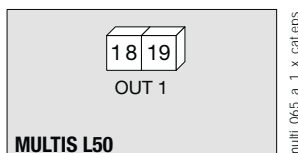

18 - 19: output n°1

3 inputs, 1 output module

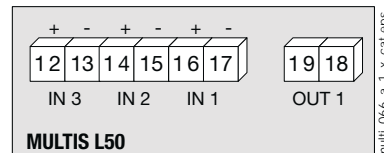

Connection

Recommendation:

- For IT earthing systems, it is recommended that the CT secondary is not connected to earth.
- When disconnecting the DIRIS, the secondary of each current transformer must be short-circuited. This operation can be carried out automatically by a SOCOMEC PTI, an accessory which is included in this catalogue. Please consult us.

Low voltage balanced network

3/4 wires with 1 CT

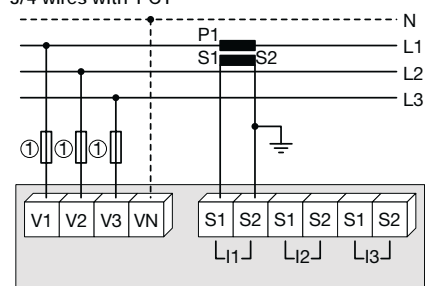

Use of 1 CT reduces by 0.5% the accuracy of the phases, the current of which is worked out by vector calculation.
1. Fuses 0.5 A gG / 0.5 A class CC.

Single-phase

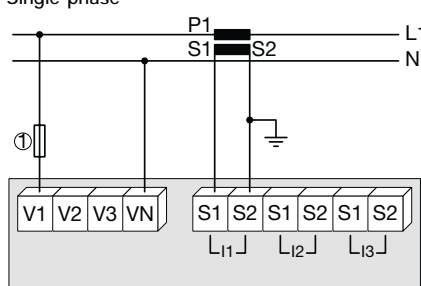

1. Fuses 0.5 A gG / 0.5 A class CC.

Two-phase

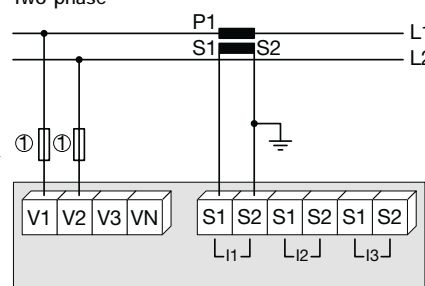

1. Fuses 0.5 A gG / 0.5 A class CC.

Low voltage unbalanced network

3/4 wires with 3 CTs

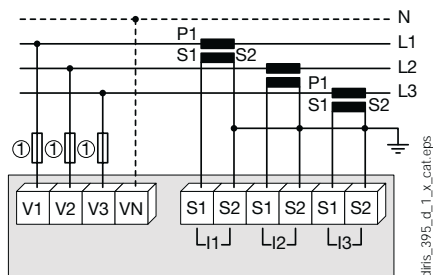

1. Fuses 0.5 A gG / 0.5 A class CC.

3 wires with 2 CTs

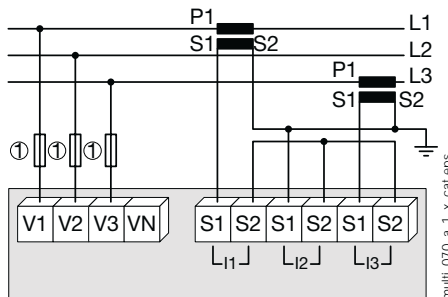

Use of 2 CTs reduces by 0.5% the accuracy of the phases, the current of which is worked out by vector calculation.

1. Fuses 0.5 A gG / 0.5 A class CC.

3 wires with 2 CTs

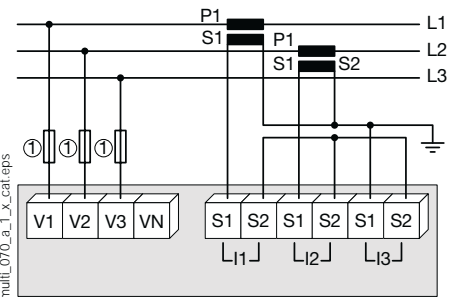

Use of 2 CTs reduces by 0.5% the accuracy of the phases, the current of which is worked out by vector calculation.

1. Fuses 0.5 A gG / 0.5 A class CC.

Additional information

Communication via RS485 link

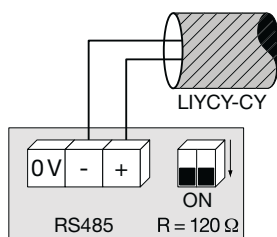

AC & DC auxiliary power supply

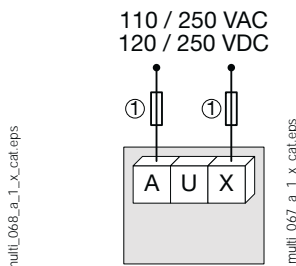

1. Fuses 0.5 A gG / 0.5 A class CC.

References

Basic device	MULTIS L50
MULTIS L50	Reference 192J 9120
Optional plug-in modules	Reference
1 output	4825 0080
RS485 MODBUS® communication	4825 0082
3 inputs, 1 output	4825 0083
Accessories	
Description of accessories	To be ordered in multiples of
IP65 protection	1
Panel mounting kit for a 144 x 96 mm cut-out	1
Fuse holder for the protection of voltage inputs (type RM) 3 poles	4
Fuse holder for the protection of the auxiliary supply (type RM) 1 pole + neutral	6
Fuse type gG 10x38 0.5 A	10
Ferrite to be associated with communication modules	1
Current transformer range	1
	Reference
	4825 0089
	4825 0088
	5601 0018
	5601 0017
	6012 0000
	4899 0011
	See page 126

Expert Services

> Study, definition, advice, implementation, maintenance and training...
Our experts "Expert Services" offer complete support for the success of your project.





DIRIS A-10

Multifunction meters - PMD
modular multifunction meter

Single-circuit metering,
measurement &
analysis



DIRIS A-10

diris_978_a_front_eps

The solution for

- > Industry
- > Infrastructures
- > Tertiary



Strong points

- > Easy to use
- > Integrated temperature sensor
- > Detects wiring errors
- > Compliant with IEC 61557-12

Conformity to standards

- > IEC 61557-12
- > IEC 62053-22 class 0.5S
- > IEC 62053-23 class 2
- > UL



Function

The **DIRIS A-10** is a modular multifunction meter for measuring electrical values in low voltage networks.

It allows all electrical parameters to be displayed and utilised for communication and/or output functions.

Advantages

Easy to use

Five direct access pushbuttons enable all measurements to be clearly viewed on its backlit LCD display.

Integrated temperature sensor

It allows variations in temperature to be detected.

Detects wiring errors

An integrated test function can be utilised to detect incorrect wiring and to automatically correct CT installation errors.

Compliant with IEC 61557-12

IEC 61557-12 is a high-level standard for all PMDs (Performance Monitoring Devices) that are designed to measure and monitor electrical parameters in distribution networks. Compliance with IEC 61557-12 ensures a high level of equipment performance, in terms of metrology, and the mechanical and environmental aspects (EMC, temperature, etc.).

Principle diagram

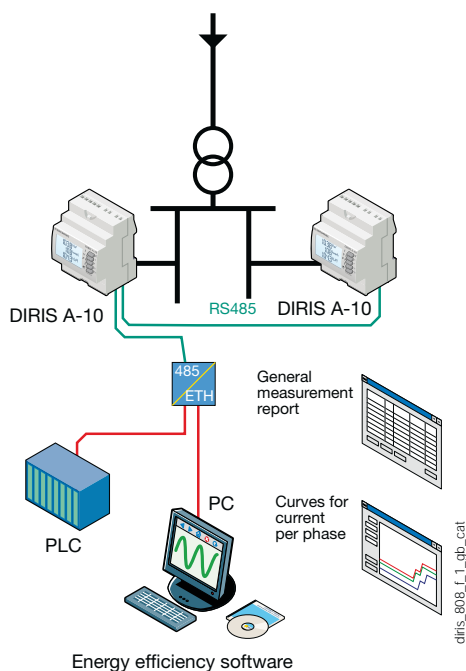

diris_808_L1_glb_cat

Functions

Multi-measurement

- Currents
 - instantaneous: I1, I2, I3, In
 - maximum average: I1, I2, I3, In
- Voltages & frequency
 - instantaneous: V1, V2, V3, U12, U23, U31, F
- Power
 - instantaneous: 3P, ΣP, 3Q, ΣQ, 3S, ΣS
 - maximum average: ΣP, ΣQ, ΣS
- Power factors
 - instantaneous: 3PF, ΣPF

Metering

- Active energy: +/- kWh
- Reactive energy: +/- kVarh
- Hours: ⌚
- Harmonic analysis
 - Total harmonic distortion (level 51)
 - Currents: thd I1, thd I2, thd I3
 - Phase-to-neutral voltage: thd V1, thd V2, thd V3
 - Phase-to-phase voltage: thd U12, thd U23, thd U31

Dual tariff function

Selection of one out of 2 billing tariffs

Events

Alarms on all electrical values

Communications⁽¹⁾

RS485 with MODBUS protocol

Input

- Tariff selection
- Remote device status

Output

- Remote command of device
- Alarm report
- Pulse report

⁽¹⁾ Available on specific version (see the following pages).

Front panel

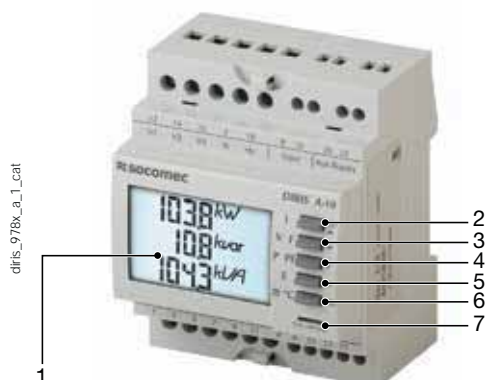

1. Backlit LCD display.
2. Direct access key for currents (instant and maximum), current THD and test function.
3. Direct access key for voltages, frequency and voltage THD.
4. Direct access key for active, reactive and apparent power (instantaneous and max. values) and power factor.
5. Direct access key for energies.
6. Pushbutton for hour meter, temperature and programming menu access.
7. Metrological LED.

Case

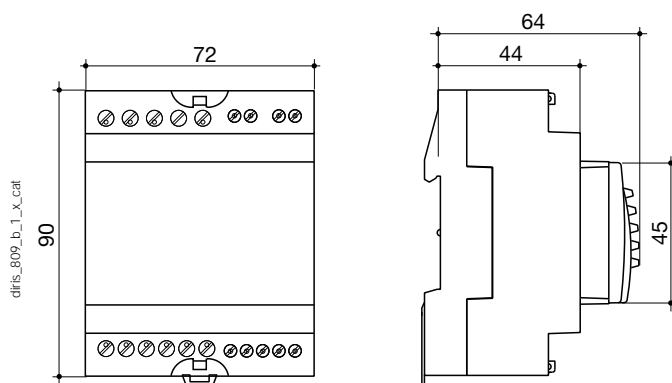

Type	modular
Number of modules	4
Dimensions W x H x D	72 x 90 x 64 mm
Case degree of protection	IP 30
Front degree of protection	IP 52
Display type	backlit LCD display
Voltage and current connection cross-section	4 mm ²
Connection cross-section for AUX supply, input, output and comms.	2.5 mm ²
Weight	205 g (4825 0010) - 215 g (4825 0011)

Electrical characteristics

Current measurement (TRMS)	
Via CT primary	9 999 A
Via CT secondary	5 A
Measurement range	0 ... 11 kA
Input consumption	0.6 VA
Measurement updating period	1 s
Accuracy	0.2 %
Permanent overload	6 A
Intermittent overload	10 I _n for 1 s
Voltage measurements (TRMS)	
Direct measurement between phases	50 ... 500 VAC
Direct measurement between phase and neutral	28 ... 289 VAC
Input consumption	≤ 0.1 VA
Measurement updating period	1 s
Accuracy	0.2 %
Power measurement	
Measurement updating period	1 s
Accuracy	0.5 %
Power factor measurement	
Measurement updating period	1 s
Accuracy	0.5 %
Frequency measurement	
Measurement range	45 ... 65 Hz
Measurement updating period	1 s
Accuracy	0.1 %

Energy accuracy	
Active (according to IEC 62053-22)	Class 0.5 S
Reactive (according to IEC 62053-23)	Class 2
Auxiliary power supply	
Alternating voltage	110 ... 277 VAC
AC tolerance	± 15 %
Frequency	50 / 60 Hz
Consumption	< 3 VA
Digital output (pulses or on/off)	
Number	1
Type	20 / 30 VDC - 0.5 A - 10 VA
Max. number of operations	≤ 10 ⁸
Input (tariff)	
Number	1
Type	0 VAC: T1 / 200-277 VAC: T2
Communication	
Link	RS485
Type	2 ... 3 half duplex wires
Protocol	MODBUS RTU
MODBUS [®] speed	2400 ... 38400 bauds
Operating conditions	
Operating temperature	- 10 ... + 55 °C
Storage temperature	- 20 ... + 70 °C
Relative humidity	85 %

DIRIS A-10

Multifunction meters - PMD
modular multifunction meter

Connection

Recommendation:

- For IT earthing systems, it is recommended that the CT secondary is not connected to earth.
- When disconnecting the DIRIS, the secondary of each current transformer must be short-circuited. This operation can be carried out automatically by a SOCOMEC PTI, an accessory which is included in this catalogue. Please consult us.
- It is recommended that the earthing point for the DIRIS A-10 and the current transformer secondaries are not earthed at the same time.

Low voltage balanced network

3/4 wires with 1 CT

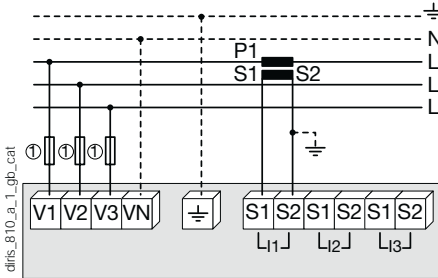

1. Fuses 0.5 A gG / 0.5 A class CC.

Single-phase

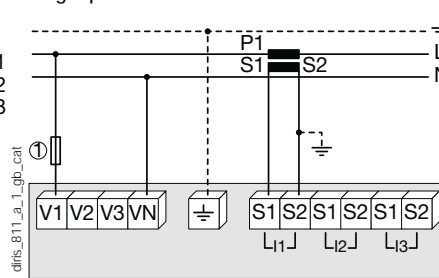

1. Fuses 0.5 A gG / 0.5 A class CC.

Two-phase

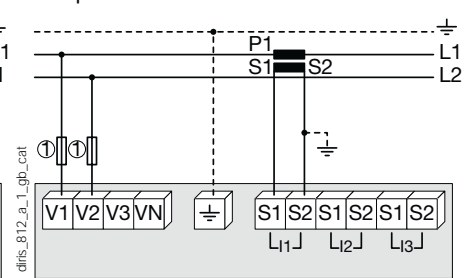

1. Fuses 0.5 A gG / 0.5 A class CC.

Low voltage unbalanced network

3/4 wires with 3 CTs

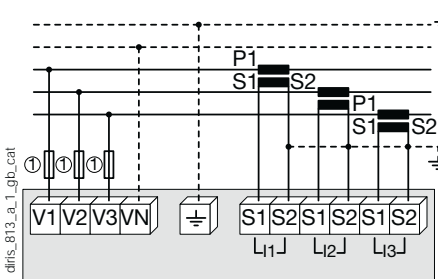

1. Fuses 0.5 A gG / 0.5 A class CC.

3 wires with 2 CTs

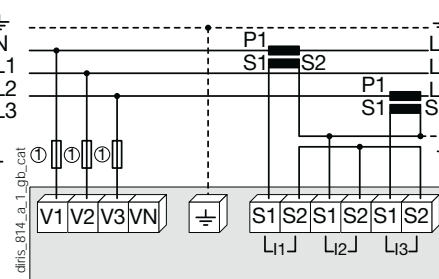

Use of 2 CTs reduces by 0.5% the accuracy of the phases, the current of which is worked out by vector calculation.
1. Fuses 0.5 A gG / 0.5 A class CC.

3 wires with 2 CTs

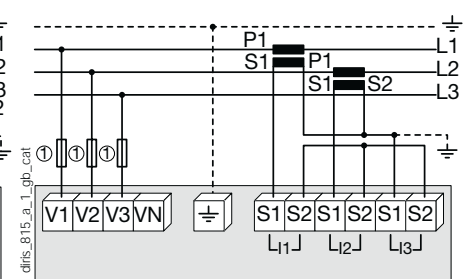

Use of 2 CTs reduces by 0.5% the accuracy of the phases, the current of which is worked out by vector calculation.
1. Fuses 0.5 A gG / 0.5 A class CC.

Additional information

Communication via RS485 link

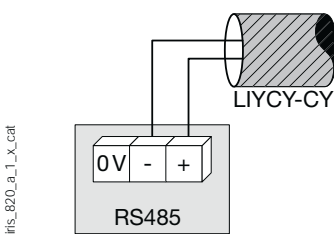

diris_820_a_1_x_cat

AC auxiliary power supply

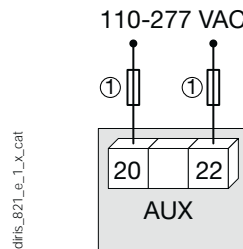

diris_821_e_1_x_cat

1. Fuses 0.5 A gG / 0.5 A class CC.

Terminals

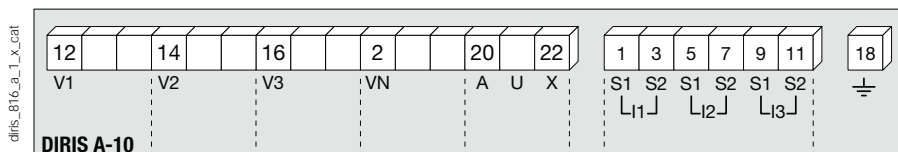

AUX: auxiliary power supply U_s .
V1, V2, V3 & VN: voltage inputs.

S1 - S2: current inputs.

Communication terminals

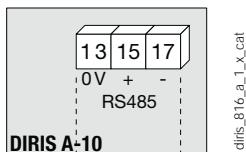

RS485 link.

Pulse or alarm output terminals

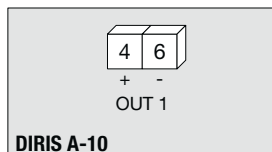

4 - 6: output n°1

Input terminals

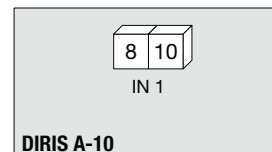

8 - 10: input n°1

References

Basic device		DIRIS A-10
Description		Reference
DIRIS A-10		4825 0400
DIRIS A-10 with RS485 MODBUS communication		4825 0401
Description of accessories	To be ordered in multiples of	Reference
Fuse disconnect switches for the protection of voltage inputs (type RM) 3 poles	4	5701 0018
Fuse disconnect switches for the protection of the auxiliary supply (type RM) 1 pole + neutral	6	5701 0017
Fuses type gG 10x38 0.5 A	10	6012 0000
Current transformer range	1	See page 46
Management software for DIRIS		See page 160

Expert Services

- > Study, definition, advice, implementation, maintenance and training... Our experts "Expert Services" offer complete support for the success of your project.





DIRIS A14

Multifunction measuring unit - PMD - MID
multi-measurement

Single-circuit metering,
measurement &
analysis



diris_964_a_1_cat

DIRIS A14 panel mounted



diris_908_a_1_cat

DIRIS A14 DIN rail mounted

The solution for

- > Industry
- > Infrastructures
- > Data centers



Strong points

- > Single phase and three phase MID certified
- > Bi-directional metering
- > Multi-measurement and load curves
- > IEC 61557-12 measuring method
- > Detection of connection errors

Compliance with standards

- > IEC 61557-12
- > IEC 62053-23 class 2
- > EN50470-1
- > EN50470-3 class C



Function

The DIRIS A14 is an MID approved multifunction meter - for measuring electrical values in low voltage networks. It allows all electrical parameters to be displayed and utilised for communication and/or output functions.

Advantages

Single phase and three phase MID certified

DIRIS A14 products with MID certification provide the guaranteed accuracy required for applications in which sub-billing of the electrical energy consumed is necessary, whether on a three-phase or single-phase network. "Module B+D" certification guarantees that the design and manufacturing process of products are approved by an accredited laboratory.

Bi-directional metering (four quadrants)

This function is for metering energy production or energy consumption.

Multi-measurement and load curve

Display of electrical values (I, U, V, ΣP , ΣQ , ΣS , PF) and P+ load curve over a 7 day period via communication.

Functional diagram

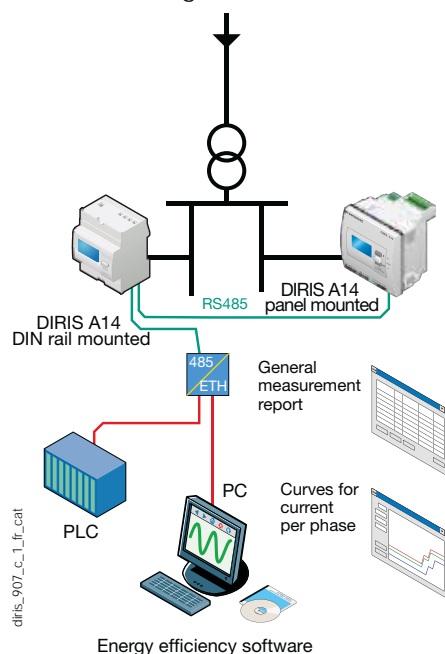

diris_907_c_1_fr_cat

IEC 61557-12 measuring method

IEC 61557-12 is a high-level standard covering all PMDs (Performance Monitoring Devices). By using the measuring method of IEC 61557-12 ensures a high level of equipment performance, in terms of metrology.

Detection of connection errors

The product is protected against phase/neutral inversion and detects wiring errors. The power supply internally derived from the voltage connections ensures realtime MID counting as soon as the mains voltage is present.

Functions

Multi-measurement

- Currents
 - instantaneous: I1, I2, I3, In
 - maximum average: I1, I2, I3, In
- Frequency
- Voltages
 - instantaneous: V1, V2, V3, U12, U23, U31, F
- Powers
 - instantaneous: ΣP , ΣQ , ΣS
 - maximum average: ΣP , ΣQ , ΣS
- Power factor (cos φ)
 - instantaneous: $\Sigma \cos \varphi$
 - maximum average: $\Sigma \cos \varphi$

Total and partial metering

- Active energy: + kWh, - kWh
- Reactive energy: + kvarh, - kvarh

Harmonic analysis (via communication)

- Total harmonic distortion (rank 63)
 - Currents: thd I1, thd I2, thd I3
 - Phase-to-neutral voltage: thd V1, thd V2, thd V3
 - Phase-to-phase voltage: thd U12, thd U23, thd U31

Multi tariff function (via communication)

Selection of one out of 4 billing tariffs

Events (via communication)

- Active energy consumption: day n-1 / week n-1 / month n-1
- Active power load curves: P 10 minutes over 7 days with time-log

Communications

RS485 with MODBUS protocol

Front panel

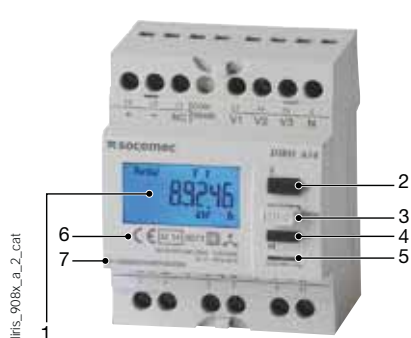

1. Backlit LCD display
2. Direct access for energies and validation key
3. Programming key
4. Navigation key for measurements
5. Metrological LED
6. MID marking
7. Serial Number



Case

DIRIS A14 DIN rail mounted

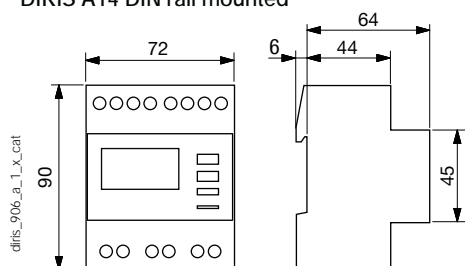

DIRIS A14 door mounted

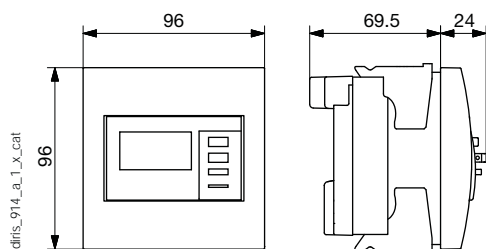

	DIRIS A14 DIN rail mounted	DIRIS A14 door mounted
Type	modular	Recessed
Number of modules	4	-
Dimensions W x H x D	72 x 90 x 64 mm	96 x 96 x 69.5 mm
Case degree of protection	IP20	
Front degree of protection	IP51	
Display type	Backlit LCD	
Rigid cable cross-section	1.5 ... 10 mm ²	
Flexible cable cross-section	1 ... 6 mm ²	
Weight	240 g	450 g

Electrical characteristics

Current measurement (TRMS)	
Via CT primary	10 ... 2500 A
Via CT secondary	5 A
Input consumption	0.6 VA
Startup current (Ist)	5 mA
Minimum current (I _{min})	50 mA
Transmission current (I _{tr})	250 mA
Reference current (I _{ref})	5 A
Measurement updating period	1 s
Accuracy	0.5%
Permanent overload	6 A
Intermittent overload	120 A for 0.5 s
Voltage measurements (TRMS)	
Direct measurement (four phases)	50 ... 460 VAC
Input consumption	2 VA
Measurement updating period	1 s
Accuracy	0.2%
Permanent overload	480 V (phase-to-phase measurement)
Power measurement	
Measurement updating period	1 s
Accuracy	0.5%
Power factor measurement (cos φ)	
Measurement updating period	1 s
Accuracy	0.01

Energy accuracy	
Active (according to IEC 62053-22)	Class 0.5 S
Reactive (according to IEC 62053-23)	Class 2
Active (according to EN 50470)	Class C
Metrological LED (EA*, EA*)	
Pulse weight	10000 pulses/kWh
Colour	Red
Auxiliary power supply	
Self-powered	Yes
Frequency	50 / 60 Hz
Communication	
Link	RS485
Type	2 to 3 half duplex wires
Protocol	MODBUS® RTU
MODBUS® speed	4800 ... 38400 bauds
Operating conditions	
Operating temperature	-10 ... +55°C
Storage temperature	-20 ... +70°C
Relative humidity	95% non-condensing

DIRIS A14

Multifunction measuring unit - PMD - MID
multi-measurement

Connection

Low voltage balanced network

Recommendation:

- For IT earthing systems, it is recommended that the CT secondary is not connected to earth.
 - When disconnecting the DIRIS, the secondary of each current transformer must be short-circuited.
- This operation can be carried out automatically by a SOCOMEC PTI, which can be found in the SOCOMEC catalogue: please consult us.

Low voltage unbalanced network

3/4 wires with 3 CTs

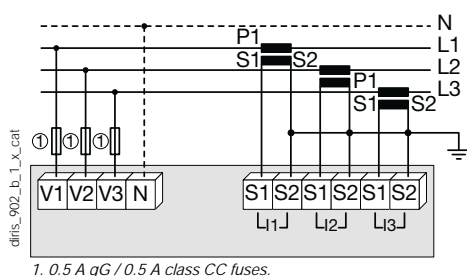

Single-phase

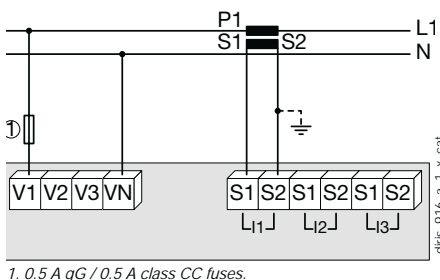

3 wires with 2 CTs

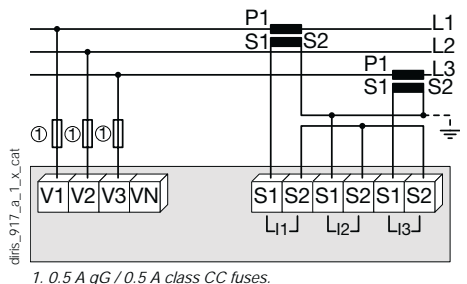

3 wires with 2 CTs

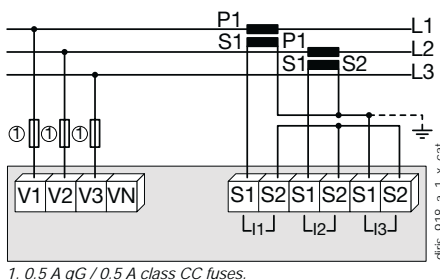

Additional information

Communication via RS485 link

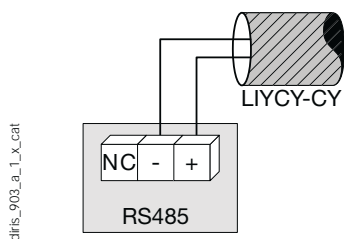

Terminals

Voltage outlets	
V	12
V2	14
V3	16
N	2
ICM (Intelligent Communication Module)	
RS485 "+"	15
RS485 "-"	17
RS485'NC"	13

Current inputs	
I1 S1	1
I1 S2	3
I2 S1	5
I2 S2	7
I3 S1	9
I3 S2	11

References

Basic device	DIRIS A14
Description	Reference
DIRIS A14 MID DIN rail mounted	4825 0020
DIRIS A14 MID panel mounted	4825 0021

Expert Services

- > Study, definition, advice, implementation, maintenance and training...
 Our experts "Expert Services" offer complete support for the success of your project.





DIRIS A-20

Multifunction power monitoring device - PMD

Multi-measurement

Single-circuit metering,
measurement &
analysis



DIRIS A-20

DAM_diris_981_a_fronteps

The solution for

- > Industry
- > Infrastructure
- > Building



Strong points

- > User-friendly operation
- > Compliant with IEC 61557-12
- > Detects wiring errors
- > Customisable

Compliance with standards

- > IEC 61557-12
- > IEC 62053-22 class 0.5S
- > IEC 62053-23 class 2
- > UL



Related software

- > To use Socomec PMDs effectively, we can offer you several dedicated software tools. See page 160.

Function

DIRIS A-20 units are performance metering and monitoring devices that provide the user with all of the measurements needed to complete energy efficient projects successfully and to provide assured monitoring of electrical distribution.

All of this information can be used and analysed remotely with the help of energy efficiency software programs.

Advantages

User-friendly operation

With its large backlit multiple-display screen with 4 hot keys, the DIRIS A-20 is easy to use.

Compliant with IEC 61557-12

Reference standard for PMDs (Performance metering & monitoring devices), IEC 61557-12 guarantees performance levels and satisfactory performance from the PMDs under the environmental conditions typical of industrial and tertiary applications.

Detects wiring errors

The DIRIS A-20 is equipped with an error correction function for CT connection.

Customisable

Additional communication and input/output modules can extend the basic functional scope of this product. Equipped with additional modules, the DIRIS A-20 can provide the user with flexibility and expandability throughout the service life of the product.

Functional diagram

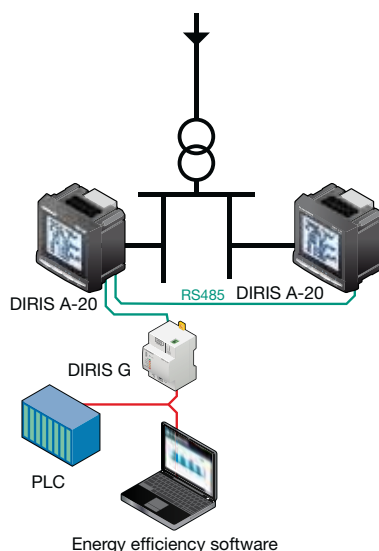

DIRIS_576_L1_en_cat

Functions

Multi-measurement

- Currents
 - instantaneous: I1, I2, I3, In
 - maximum average: I1, I2, I3, In
- Voltages & frequency
 - instantaneous: V1, V2, V3, U12, U23, U31, F
- Powers
 - instantaneous: 3P, ΣP, 3Q, ΣQ, 3S, ΣS
 - maximum average: ΣP, ΣQ, ΣS
- Power factors
 - instantaneous: 3PF, ΣPF

Metering

- Active energy: +/- kWh
- Reactive energy: +/- kvarh
- Hours: ⌚

Harmonic analysis

- Total harmonic distortion (rank 51)
 - Currents: thd I1, thd I2, thd I3
 - Phase-to-neutral voltage: thd V1, thd V2, thd V3
 - Phase-to-phase voltage: thd U12, thd U23, thd U31

Events

Alarms on all electrical parameters

Communications⁽¹⁾

RS485 with MODBUS protocol

Output

- Equipment control
- Alarm report
- Pulse report

Input

- Information report from a dry external contact

(1) Available as an option (see the following pages).

Front panel



1. Backlit LCD display
2. Pushbutton for currents (instantaneous and maximum), THD currents and the connection correction function.
3. Pushbutton for voltages, frequency and THD voltages.
4. Pushbutton for power (instantaneous and maximum), active, reactive and effective, power factor.
5. Pushbutton for energy sources and timer counter.

Case

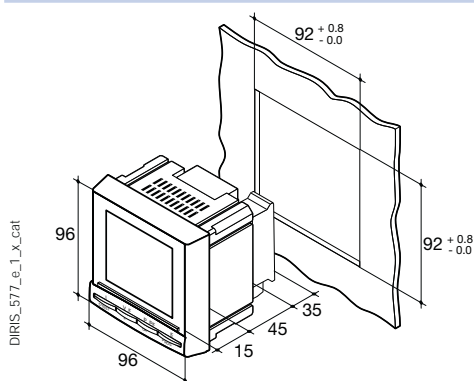

Type	Plug-in
Dimensions L x H x P	96 x 96 x 60 mm
Case degree of protection	IP30
Front degree of protection	IP52
Display type	Backlit LCD
Type of terminal strips	Fixed or removable
Section for connection of voltages and other terminals	0.2 ... 2.5 mm ²
Section for connection of currents	0.5 ... 6 mm ²
Weight	400 g

Plug-in optional modules

DIRIS® A-20



1 output

- 1 output that can be configured for:
- pulses: configurable (type, weight, duration) to kWh or kVarh.
 - Monitoring: 3I, In, 3V, 3U, F, ΣP, ΣQ, ΣS, ΣPFL/C, THD 3I, THD 3V, THD 3U and timer meter.
 - Equipment control



Communication

RS485 link with MODBUS protocol (speed up to 38 400 baud).



3 inputs , 1 output

- 3 inputs can be configured into:
- Information report from an external contact.
- 1 output that can be configured for:
- pulses: configurable (type, weight, duration) to kWh or kVarh.
 - Monitoring: 3I, In, 3V, 3U, F, ΣP, ΣQ, ΣS, ΣPFL/C, THD 3I, THD 3V, THD 3U and timer meter.
 - Equipment control

Accessories

Current transformer (see page 46)

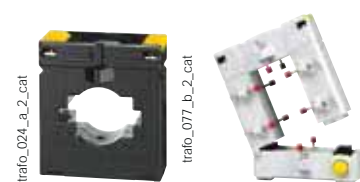

IP65 protection



DIRIS A-20

Multifunction power monitoring device - PMD

Multi-measurement

Electrical characteristics

Current measurement (TRMS)	
Via CT primary	9 999 A
Via CT secondary	5 A
Measurement range	0 ... 11 kA
Input consumption	0.6 VA
Measurement updating period	1 s
Accuracy	0.2%
Permanent overload	6 A
Intermittent overload	10 I _n over 1 sec
Voltage measurements (TRMS)	
Direct measurement between phases	50 ... 500 VAC
Direct measurement between phase and neutral	28 ... 289 VAC
Input consumption	≤ 0.1 VA
Measurement updating period	1 s
Accuracy	0.2%
Power measurement	
Measurement updating period	1 s
Accuracy	0.5%
Power factor measurement	
Measurement updating period	1 s
Accuracy	0.5%
Frequency measurement	
Measurement range	45 ... 65 Hz
Measurement updating period	1 s
Accuracy	0.1%

Energy accuracy	
Active (according to IEC 62053-22)	Class 0.5 S
Reactive (in acc. with CEI 62053-23)	Class 2
Auxiliary power supply	
Alternative voltage	110 ... 400 VAC
AC tolerance	± 10%
DC voltage	120 ... 289 VDC
DC tolerance	± 20%
Frequency	50 / 60 Hz
Power consumption	10 VA
Pulse or alarm output	
Number	1
Type	100 VDC - 0.5 A - 10 VA
Max. number of manoeuvres	≤ 10 ⁸
Inputs	
Number	3
Power supply	10 ... 30 VDC
Minimum width of signal	10 ms
Minimum length between 2 pulses	18 ms
Type	Optical couplers
Communication	
Link	RS485
Type	2 to 3 half duplex wires
Protocol	MODBUS® in RTU mode
MODBUS® speed	1400 ... 38400 baud
Operating conditions	
Operating temperature range	- 10 ... + 55°C
Storage temperature	- 20 ... + 85°C
Relative humidity	95%

Terminals

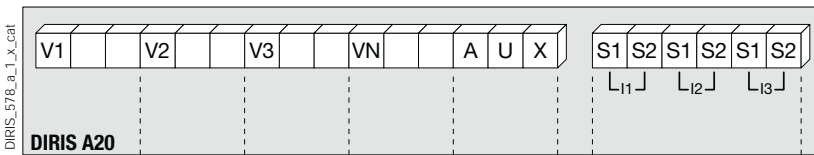

S1 - S2: current inputs.

AUX: auxiliary power supply U_s.
V1, V2, V3 & VN: voltage inputs.

Module communication

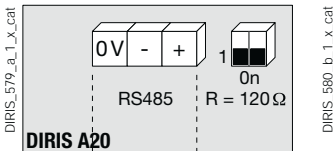

RS485 link.
R = 120 Ω: internal resistance for the RS485 link.

Output or alarm module

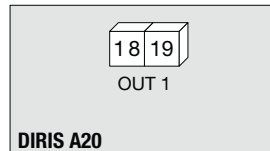

18 - 19: output n°1

Module with 3 inputs, 1 output

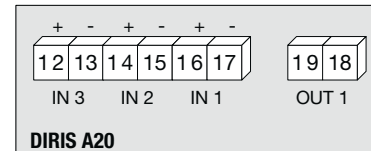

Connection

Low voltage balanced network

Recommendation

- For IT earthing systems, it is recommended that the CT secondary is not connected to earth.
- When disconnecting the DIRIS, the secondary of each current transformer must be short-circuited. This operation can be carried out automatically by a SOCOMEC PTI, which can be found in the SOCOMEC catalogue: please consult us.

3/4 wires with 1 CT

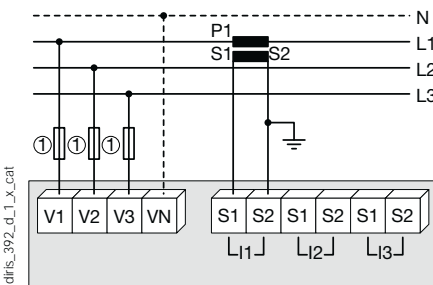

The 1CT solution reduces by 0.5% the accuracy of the phase for which the current is deduced by a vector calculation.
1. 0.5 A gG / 0.5 A class CC fuses.

Single-phase

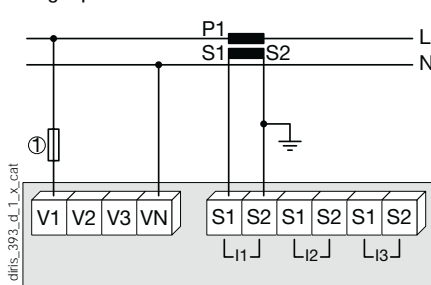

1. 0.5 A gG / 0.5 A class CC fuses.

Two-phase

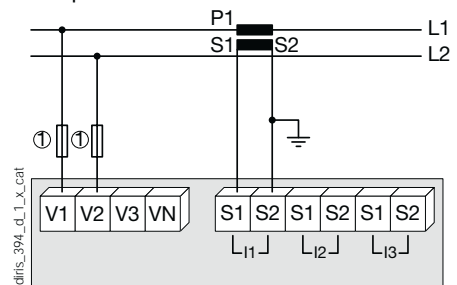

1. 0.5 A gG / 0.5 A class CC fuses.

Low voltage unbalanced network

3/4 wires with 3 CTs

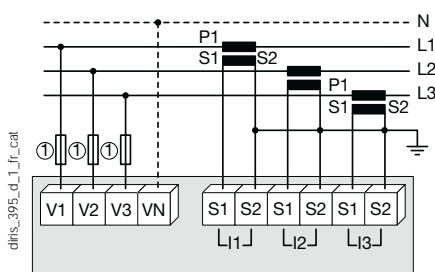

1. 0.5 A gG / 0.5 A class CC fuses.

3 wires with 2 CTs

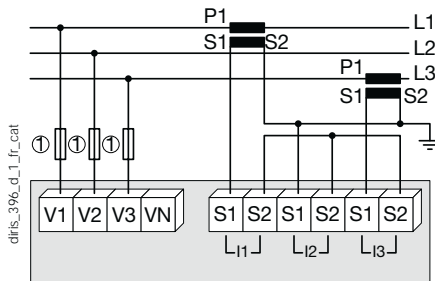

The 2CT solution reduces by 0.5% the accuracy of the phase for which the current is deduced by a vector calculation.

1. 0.5 A gG / 0.5 A class CC fuses.

3 wires with 2 CTs

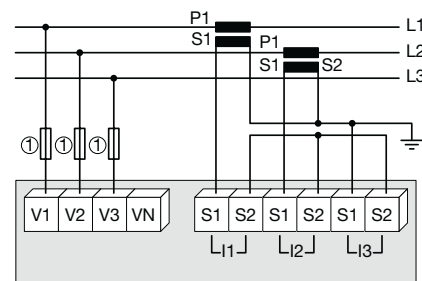

The 2CT solution reduces by 0.5% the accuracy of the phase for which the current is deduced by a vector calculation.

1. 0.5 A gG / 0.5 A class CC fuses.

Additional information

Communication via RS485 link

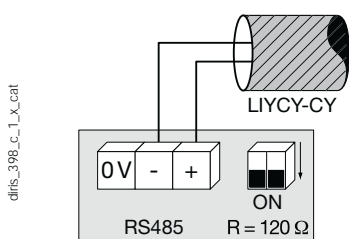

AC and DC auxiliary power supply

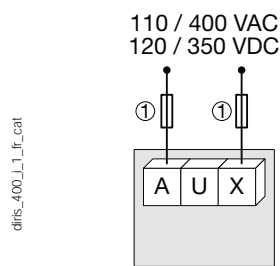

1. 0.5 A gG / 0.5 A class CC fuses.

References

Basic device	DIRIS A-20	
Auxiliary power supply U_s	Reference	
110 ... 400 VAC / 120 ... 350 VDC	4825 0402	
Options		
Plug-in modules	Reference	
On/Off output.	4825 0080	
RS485 MODBUS® communication	4825 0082	
3 inputs, 1 output	4825 0083	
Accessories		
Description of accessories	To be ordered in multiples of	Reference
Protection IP65	1	4825 0089
Plug-in kit for cutout 144 x 96 mm	1	4825 0088
Fuse holders to protect voltage inputs (type RM) 3 pole	4	5601 0018
Fuse holders to protect the auxiliary power supply (type RM) 1 pole + neutral	6	5601 0017
gG 10x38 0.5 A fuses	10	6012 0000
Ferrite for use with communication modules	1	4899 0011
Current transformer range	1	See page 46
Software associated with DIRIS		See page 160

Expert Services

> Study, definition, advice, implementation, maintenance and training ...
Our experts "Expert Services" offer complete support for the success of your project.





DIRIS A-30/A-41

Multifunction power monitoring device - PMD
Energy monitoring

Single-circuit metering,
measurement &
analysis



DIRIS A-30

diris_984_from.psd

The solution for

- > Industry
- > Building
- > Infrastructures



Strong points

- > User-friendly operation
- > Detects wiring errors.
- > Customisable
- > Compliant with IEC 61557-12

Compliance with standards

- > IEC 61557-12
- > IEC 62053-22 class 0.5 S
- > IEC 62053-23 class 2
- > UL



Function

The DIRIS A-30 and A-41 are power monitoring devices that provide the user with all of the measurements needed to complete energy efficiency projects and to assure the monitoring of electrical distribution.

All the information can be used and analysed remotely using energy efficiency software packages.

Advantages

User-friendly operation

With its large backlit multiple-display screen with 6 hot keys, the DIRIS A-30 is easy to use.

Detects wiring errors.

The DIRIS A-30 is provided with a correction function for TC wiring errors.

Customisable

The DIRIS A-30 can be equipped with additional modules that give the user flexibility throughout the service life of the product. Communication modules and additional digital or analogue inputs/outputs can be used to increase its range of functionality.

Functional diagram

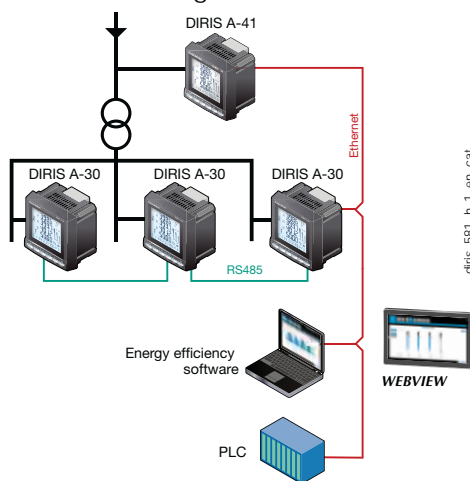

diris_581_h_1_en_cat

Compliant with IEC 61557-12

Reference standard for PMDs (Performance metering & monitoring devices), IEC 61557-12 guarantees performance levels and satisfactory performance from the PMDs under the environmental conditions typical of industrial and tertiary applications.

Functions

Multi-measurement

- Currents
 - instantaneous: I1, I2, I3, In, Isystem
 - average/max average: I1, I2, I3, In
- Voltages & frequency
 - instantaneous: V1, V2, V3, U12, U23, U31, F, Vsystem, Ussystem
 - average/max average: V1, V2, V3, U12, U23, U31, F
- Powers
 - instantaneous: 3P, ΣP, 3Q, ΣQ, 3S, ΣS
 - max average: ΣP, ΣQ, ΣS
 - predictive: (ΣP), (ΣQ), (ΣS)
- Power factors
 - instantaneous: 3PF, ΣPF
 - average/max average: ΣPF

- Kfactor
- Temperatures⁽¹⁾
 - internal
 - external via 3 PT100 probes

Metering

- Active energy: +/- kWh
- Reactive energy: +/- kvarh
- Effective power: kVAh
- Hours: ⌚

Harmonic analysis

- Level of harmonic distortion
 - Currents: thd I1, thd I2, thd I3, thd In
 - Phase-to-neutral voltage: thd V1, thd V2, thd V3
 - Phase-to-phase voltage: thd U12, thd U23, thd U31

- Individual harmonics up to 63rd
 - Currents: HI1, HI2, HI3, HIn
 - Phase-to-neutral voltage: HV1, HV2, HV3,
 - Phase-to-phase voltages: HU12, HU23, HU31
- Load curve⁽¹⁾
 - Active & reactive power: ΣP+/-; ΣQ+/-
 - Voltages & frequency: V1, V2, V3, U12, U23, U31, F
- Events⁽¹⁾
 - Alarms on all electrical parameters.

Communications⁽¹⁾

- RS485 (Modbus)
- Ethernet (Modbus/TCP or Modbus RTU)
- Ethernet with RS485 Modbus RTU gateway over TCP
- Profibus DP Sub-D9

Inputs/ Outputs⁽¹⁾

- Pulse counting
- Checking / control of equipment
- Alarm report
- Pulse report

Analogue output

- Analogue 0/4- 20 mA
- (1) Available as an option (see following pages).

Front panel



1. Backlit LCD display
2. Pushbutton for currents and for connection correction function
3. Pushbutton for voltages and frequency.
4. Pushbutton for active, reactive and effective powers and for power factor.
5. Pushbutton for maximum and average values for currents and power levels.
6. Pushbutton for harmonics.
7. Pushbutton for electrical energy meters, timers and impulse counters

Plug-in modules

DIRIS® A-30



diris_773_a

DIRIS® A-41*



diris_774_a

* With current measurement module for Neutral as standard.



Pulse outputs

2 configurable pulse outputs (type, weight and run) on \pm kWh, \pm kvarh and kVAh.



MODBUS® communication

RS485 link with MODBUS® protocol (speed up to 38400 baud).



PROFIBUS® DP communication

SUB-D9 link with PROFIBUS® DP protocol (speed up to 12 Mbaud).



Analogue outputs

You can connect a maximum of 2 modules, i.e. 4 analogue outputs.
2 outputs can be allocated to:
3I, In, 3V, 3U, F, \pm Σ P, \pm Σ Q, Σ S, Σ PFL/C, Isys, Vsys, Usys, Ppred, Qpred, Spred, T°C internal, T°C 1, T°C 2, T°C3 and to 30 VDC power supply.



2 inputs - 2 outputs

You can connect a maximum of 3 modules, i.e. 6 inputs / 6 outputs.
2 outputs can be allocated to:
- monitoring: 3I, In, 3V, 3U, F, \pm Σ P, \pm Σ Q, Σ S, Σ PFL/C, THD 3I, THD In, THD 3V, THD 3U, Ppred, Qpred, Spred, T°C internal, T°C 1, T°C2, T°C3 and of time counter,
- remote control,
- timed remote control,
- 2 inputs for pulse counting.



Storage capability

- Memory function up to max. 62 days for P+, P-, Q+, Q- with a TOP for internal or external synchronisation of 5, 8, 10, 15, 20, 30 and 60 minutes.
- Memory function for the last 10 timed and dated alarms.
- Memory function for the last min and max instantaneous values for 3U, 3V, 3I, In, F, Σ P \pm , Σ Q \pm , Σ S, THD 3U, THD 3V, THD, 3U, THD, 3V, THD, 3I, THD In.
- Memory function of average values 3U, 3V et F as a function of synchronisation (maximum 60 days).



Ethernet communication

- Ethernet link with MODBUS/TCP or MODBUS RTU over TCP.



Ethernet communication with RS485 MODBUS gateway

- Ethernet link with MODBUS/TCP or MODBUS RTU over TCP.
- Connect 1 to 247 RS485 MODBUS slaves.

DIRIS A-30/A-41

Multifunction power monitoring device - PMD

Energy monitoring

Accessories

Current transformer



IP65 protection



Terminals

DIRIS A-30

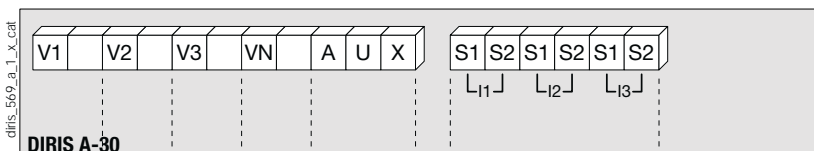

S1 - S2: current inputs

AUX: auxiliary power supplies U_s

V1 - V2 - V3 - VN: voltage inputs

DIRIS A-41

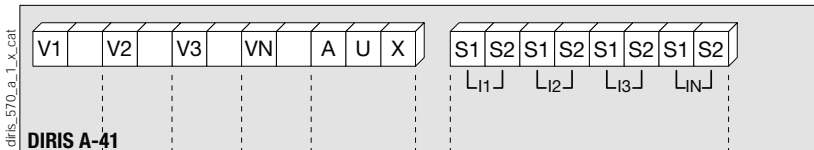

S1 - S2: current inputs

AUX: auxiliary power supplies U_s

V1 - V2 - V3 - VN: voltage inputs

Communication module

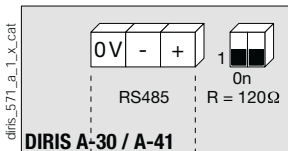

RS485 link.

R = 120 Ω : internal resistance for the RS485 link.

Pulse output module

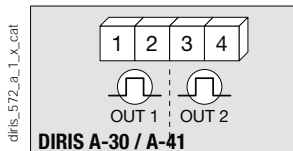

1 - 2: pulse output n°1.

3 - 4: relay output n°2.

Analogue output module

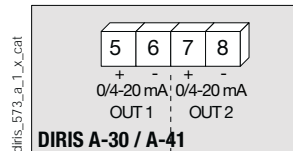

5 - 6: analogue output n°1.

7 - 8: analogue output n°2.

2 input / 2 output module

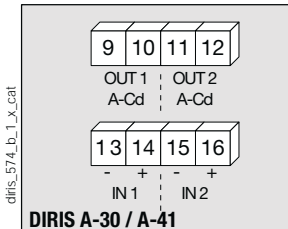

9 - 10: relay output n°1.

11 - 12: relay output n°2.

13 - 14: optical input n°1.

15 - 16: optical input n°2.

Memory module

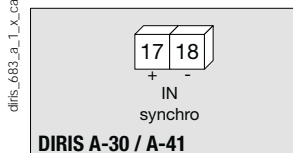

17 - 18: synchronisation input.

Temperature module

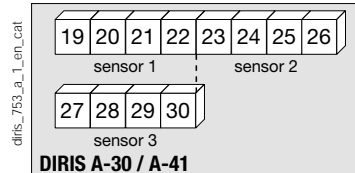

Probe 1	Probe 2	Probe 3
19: red	23: red	27: red
20: red	24: red	28: red
21: white	25: white	29: white
22: white	26: white	30: white

Ethernet module

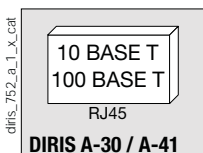

DIRIS A-30 / A-41

Ethernet module + RS485 MODBUS gateway

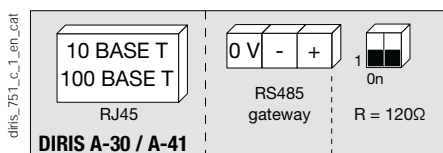

DIRIS A-30 / A-41

Electrical characteristics

Measurement of currents on insulated inputs (TRMS)	
Via CT primary	9,999 A
Via CT secondary	1 or 5 A
Measurement range	0 ... 11 kA
Input consumption	≤ 0,1 VA
Measurement updating period	1 s
Accuracy	0.2%
Permanent overload	6 A
Intermittent overload	10 I _n for 1 s
Voltage measurements (TRMS)	
Direct measurement between phases	50 to 1039 VAC
Direct measurement between phase and neutral	28 to 600 VAC
VT primary measurement	500,000 VAC
VT secondary measurement	60, 100, 110, 173, 190 VAC
Frequency	50 / 60 Hz
Input consumption	≤ 0,1 VA
Measurement updating period	1 s
Accuracy	0.2%
Current - voltage product	
Limitation for TC 1 A	10,000,000
Limitation for TC 5 A	10,000,000
Power measurement	
Measurement updating period	1 s
Accuracy	0.5%
Power factor measurement	
Measurement updating period	1 s
Accuracy	0.5%
Frequency measurement	
Measurement range	45 ... 65 Hz
Measurement updating period	1 s
Accuracy	0.1%
Energy accuracy	
Active (according to IEC 62053-22)	Class 0.5 S
Reactive (according to IEC 62053-23)	Class 2
Auxiliary power supply	
Alternative voltage	110 ... 400 VAC
AC tolerance	± 10 %
Direct current	120 ... 350 VDC / 12 ... 48 VDC
DC tolerance	± 20 % / - 6 ... + 20 %
Frequency	50 / 60 Hz
Power consumption	≤ 10 VA

Module 2 inputs - 2 outputs: outputs (alarms / control)	
Number of relays	2 ⁽¹⁾
Type	250 VAC - 5 A - 1150 VA
Module 2 inputs - 2 outputs: optical coupler inputs	
Number	2 ⁽¹⁾
Power supply	10 ... 30 VDC
Minimum width of signal	10 ms
Minimum length between 2 pulses	18 ms
Type	Optical couplers
Pulse output module	
Number of relays	2
Type	100 VDC - 0.5 A - 10 VA
Max. number of manoeuvres	≤ 10 ⁸
Analogue output module	
Number of outputs	2 ⁽²⁾
Type	Insulated
Scale	0 / 4 ... 20 mA
Load resistance	600 Ω
Maximum current	30 mA
MODBUS communication module	
Link	RS485
Type	2 to 3 half duplex wires
Protocol	MODBUS [®] RTU
MODBUS [®] speed	4800 to 38400 baud
PROFIBUS DP communication module	
Link	SUB-D9
Protocol	PROFIBUS [®] DP
PROFIBUS [®] speed	9.8 kbaud ... 12 Mbaud
Ethernet communication module	
Connection technology	RJ45
Baud rate	10 base T / 100 base T
Protocol	MODBUS TCP or MODBUS RTU on TCP
Temperature module (inputs)	
Type	PT100
Connection	2, 3 or 4 wires
Dynamic	- 20°C ... 150°C
Accuracy	± 1 digit
Maximum length	300 cm
Operating conditions	
Operating temperature range	-10 to +55°C
Storage temperature	-20 to 85°C
Relative humidity	95%

(1) Max. 3 modules / DIRIS.

(2) Max. 2 modules / DIRIS.

Case

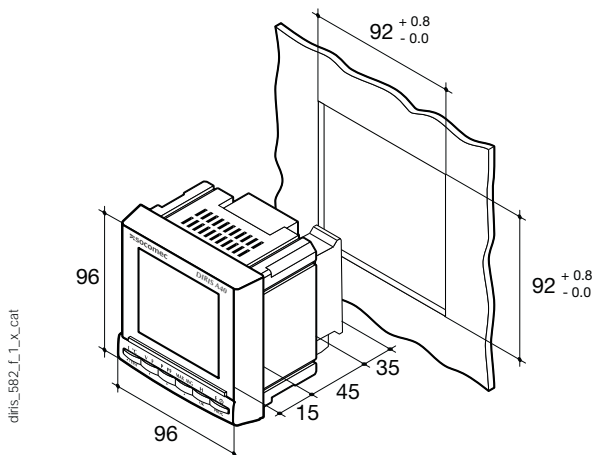

Type	Panel mounting
Dimensions W x H x D	96 x 96 x 60 mm
Case degree of protection	IP30
Front degree of protection	IP52
Display type	Backlit LCD display
Type of terminal strips	Fixed or detachable
Section of connection for voltages and other terminals	0,2 ... 2.5 mm ²
Section of connection for currents	0.5 ... 6 mm ²
Weight	400 g

DIRIS A-30/A-41

Multifunction power monitoring device - PMD

Energy monitoring

Connections

Balanced low-voltage network for DIRIS A-30

Recommendation: When disconnecting the DIRIS, the secondary of each current transformer must be short-circuited. This operation can be carried out automatically by a SOCOMEC PTI, which can be found in the SOCOMEC catalogue: please consult us. In TNC mode, it is advisable to connect the DIRIS A-30/A-41 to earth using the functional earth module.

3/4 wires with 1 CT

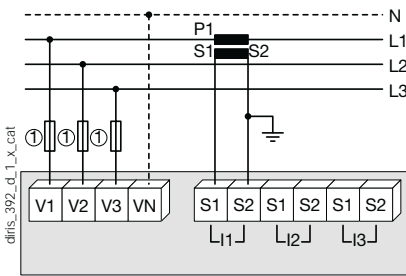

The use of 1 TC reduces by 0.5% the accuracy of the phases, the current for which is worked out by vector calculation.
1. 0.5 A gG / 0.5 A class CC fuses.

Single-phase

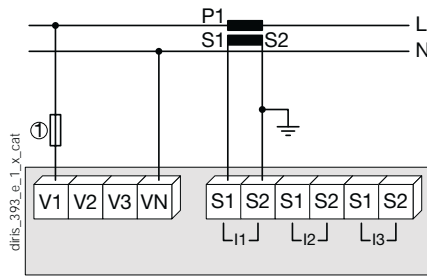

1. 0.5 A gG / 0.5 A class CC fuses.

Two-phase

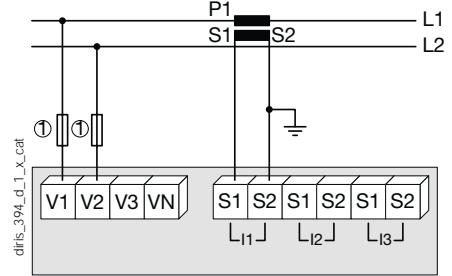

1. 0.5 A gG / 0.5 A class CC fuses.

Balanced low-voltage network for DIRIS A-30

3/4 wires with 3 CTs

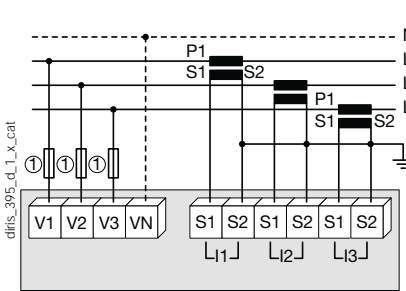

1. 0.5 A gG / 0.5 A class CC fuses.

3 wires with 2 CTs

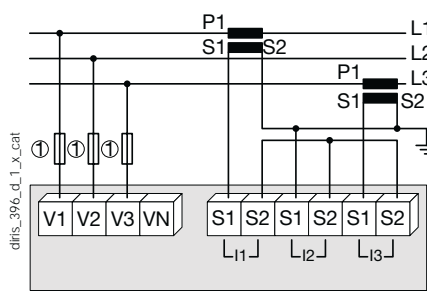

The use of 2 TC reduces by 0.5% the accuracy of the phase, the current for which is worked out by vector calculation.
1. 0.5 A gG / 0.5 A class CC fuses.

3 wires with 2 CTs

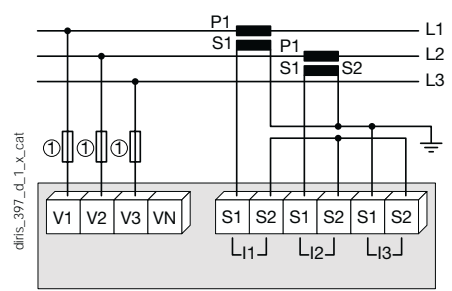

The use of 2 TC reduces by 0.5% the accuracy of the phase, the current for which is worked out by vector calculation.
1. 0.5 A gG / 0.5 A class CC fuses.

Balanced low-voltage network for DIRIS A-41

4 wires with 4 CTs

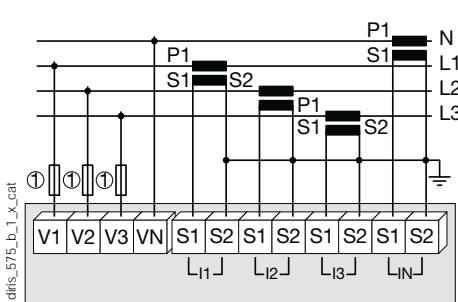

1. 0.5 A gG / 0.5 A class CC fuses.

Additional information

Communication via RS485 link

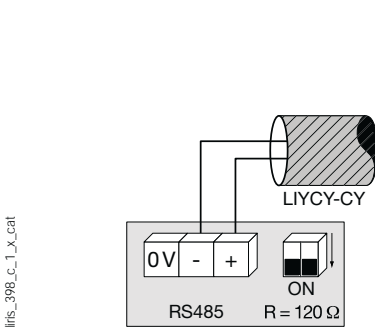

Connection of potential transformer for HV networks

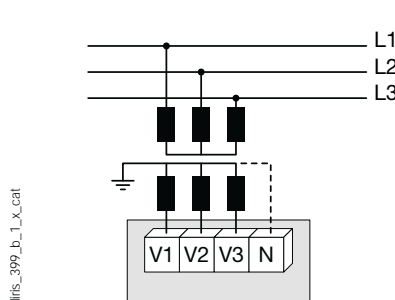

AC and DC auxiliary power supply

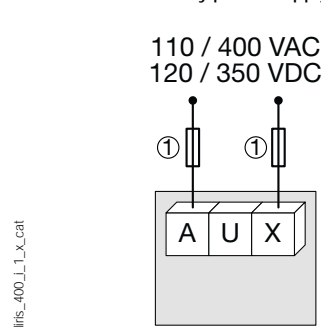

1. 0.5 A gG / 0.5 A class CC fuses.

References

Basic device	DIRIS A-30		DIRIS A-41 With TC on the neutral
Auxiliary power supply U_s	Reference		Reference
110 ... 400 VAC / 120 ... 350 VDC	4825 0403		4825 0404
12 ... 48 VDC	4825 0405		4825 0406

Options			
Plug-in modules⁽¹⁾	Reference		Reference
Pulse outputs	4825 0090		4825 0090
RS485 MODBUS [®] communication	4825 0092		4825 0092
PROFIBUS [®] DP communication	4825 0205		4825 0205
Analogue outputs	4825 0093		4825 0093
2 inputs - 2 outputs	4825 0094		4825 0094
Storage capability	4825 0097		4825 0097
Ethernet communication ⁽²⁾	4825 0203		4825 0203
Ethernet communication + RS485 gateway ⁽²⁾	4825 0204		4825 0204
Temperature inputs.	4825 0206		4825 0206

(1) Ease of integration of additional functions (maximum 4 slots on A-30 and 3 on A-41).

(2) Dimensions: 2 slots.

Accessories				
Description of accessories	To be ordered in multiples of	Reference	To be ordered in multiples of	Reference
IP65 protection.	1	4825 0089	1	4825 0089
Integration kit for 144 x 96 mm cutout	1	4825 0088	1	4825 0088
Fuse holders to protect voltage inputs (type RM) 3 pole	4	5701 0018	4	5701 0018
Fuse holders to protect the auxiliary power supply (type RM) 1 pole + neutral	6	5701 0017	6	5701 0017
gG 10x38 0.5 A fuses	10	6012 0000	10	6012 0000
Range of current transformers	1	See "TE sensors" pages	1	See "TE sensors" pages
Ferrite for use with communication modules	1	4899 0011		4899 0011
PT100 temperature probe, M6 screw	1	4825 0208	1	4825 0208
PT100 temperature probe, M6 lug	1	4825 0209	1	4825 0209
Associated DIRIS software		See "Management software tools" pages		

Expert Services

- > Study, definition , advice, implementation , maintenance and training...
Our experts "Expert Services" offer complete support for the success of your project.





DIRIS A-40

Multi-function meters

Single-circuit metering & measurement



DIRIS A-40

Function

The DIRIS A-40 is a panel-mounted power monitoring device (PMD). It is designed for measuring, monitoring and reporting electrical energy.

The DIRIS A-40 offers a range of functions for measuring voltage, current, power, energy and quality. It allows the analysis of a single-phase or three-phase load.

Advantages

Assisted configuration

The configuration wizard guides the user step by step. It also detects and corrects configuration errors. This cuts the commissioning time in half and always delivers a reliable result.

Smart sensors

Three current sensor formats (solid-core TE, split-core TR/ITR and Rogowski coil TF) allow integration of the DIRIS A-40 into new and existing electrical installations.

Connected to the Cloud

The range comprises IoT ready connected products that enable data to be exported automatically for remote operation without any limit on time, distance and time in storage.

Compliant with IEC 61557-12

Reference standard for PMDs (Performance metering & monitoring devices), IEC 61557-12 standard guarantees performance levels and satisfactory performance from the PMDs under the environmental conditions typical of industrial and tertiary applications.

The solution for

- > Industry
- > Building
- > Infrastructure



Strong points

- > Assisted configuration
- > Connected to the Cloud
- > Compliant with IEC 61557-12
- > Smart sensors

Integrated technologies



For more information see our website www.socomec.com

Conformity to standards

- > IEC 61557-12
- > UL E257746
- > EN 50160



Functions

Multi-measurement

- Currents
 - I1, I2, I3, In, Isystem
- Voltages & frequency
 - V1, V2, V3, VN, Vsystem, U12, U23, U31, Usystem, f
- Powers
 - P1, P2, P3, ΣP, Q1, Q2, Q3, ΣQ, S1, S2, S3, ΣS
 - Predictive powers ΣP, ΣQ, ΣS
- Power factor
 - PF1, PF2, PF3, ΣPF
- Cos φ & tangent φ
 - Instantaneous values per phase

Metering

- Active energy: +/- kWh
- Reactive energy: +/- kvarh
- Apparent power: kVAh
- Multi-tariff (8 max.)
- Hour Meter

Quality

- Voltage Unbalance
 - Vdir, Vinv, Vhom, Udir, Uinv, Unba, Vnba, Vnb, Unb
- Current unbalance
 - Idir, linv, Ihom, Inba, Inb
- Total harmonic distortion
 - Currents THDi1, THDi2, THDi3, THDiN, TDDI
 - Phase-to-neutral voltage THDv1, THDv2, THDv3
 - Phase-to-phase voltage THDu12, THDu23, THDu31
- Individual harmonics up to 63rd
 - Currents: HI1, HI2, HI3, HIn
 - Phase-to-neutral voltage: HV1, HV2, HV3
 - Phase-to-phase voltage: HU12, HU23, HU31
- Kfactor & Crest factor
- Events according to EN 50160
 - Voltage dips, outages, interruptions, swells

Monitoring of protection

- Auxiliary contact monitoring
- Report and alarm on trips
- Number of operations

Load curves and historical records (max. 130 days)

- Active, reactive and apparent power
- Currents, voltages and frequency

Alarms

- Alarms for all electrical values, events and input status changes, possibility of logical combination
- Time-stamping of events

Communication

- DIRIS A-40 RS485 Modbus as standard
- DIRIS A-40 Ethernet Modbus
- DIRIS A-40 PROFIBUS DPV1

Inputs

- 3 digital inputs
 - Power supplied from DIRIS A-40 or an external source
 - Function: logic status, status of circuit breaker, counting of pulses or synchronization multifunction metering
- 2 logical outputs
 - Function: Command, energy pulse output, load shedding, alarm

Functions

Monitoring

- Real-time measurement of electrical values.
- View data as graphs or tables.
- Power quality analysis of the utility supply and of loads.



Metering

- Measurement of active, reactive and apparent energies.
- Historical record of measurements.
- Graphic display on monthly, weekly, daily or hourly basis.



Alarming

- Display of alarms.
- History of alarms.



Terminals

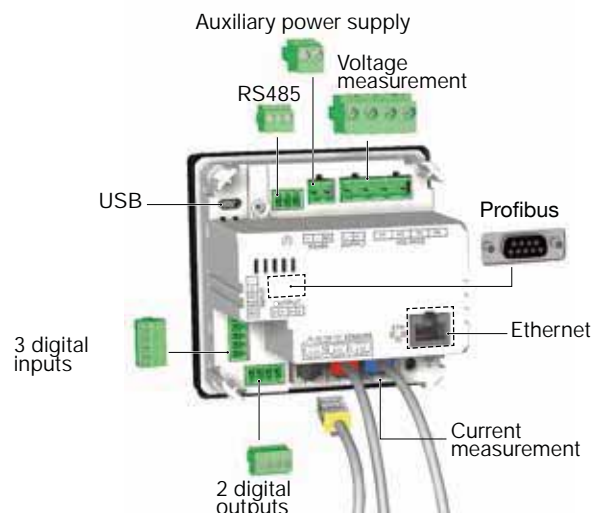

Dimensions (mm)

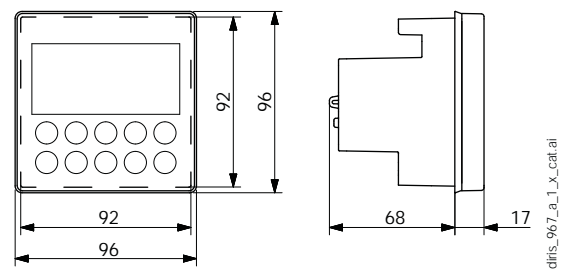

Current measurement

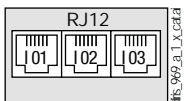

3 inputs supplied by the product

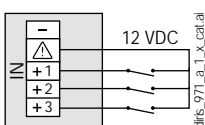

3 inputs with external power supply

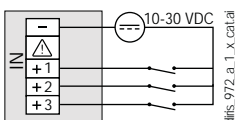

Voltage connections inc auxiliary power supply

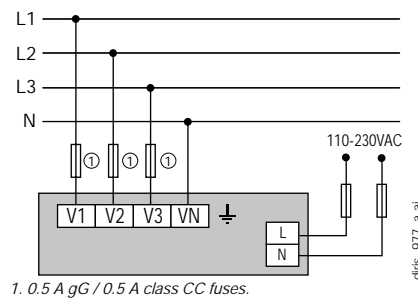

2 outputs

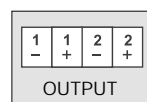

Earth



RS485

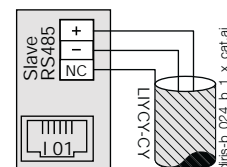

Connections

Associated current sensors

Various types of current sensors can be connected to the DIRIS A-40: solid-core (TE), split-core (TR/iTR) or Rogowski (TF). This range of sensors is suitable for all types of new or existing installations. A quick RJ12 connection makes wiring easy and reliable and prevents wiring errors. The DIRIS A-40 automatically recognizes the sensor size and type. This guarantees the overall accuracy of the DIRIS A-40 + current sensor measurement chain.
 For more information: see "TE sensors" pages.

TE solid current sensors

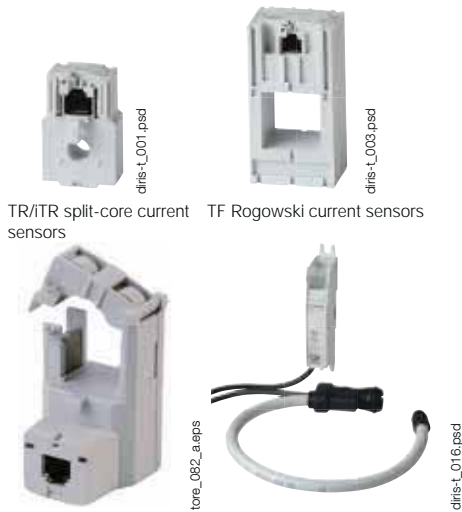

TE / TR/iTR / TF current sensors



Network and connection examples

Three phase + Neutral

3P+N - 3 CT (1 three-phase load + calculated Neutral)

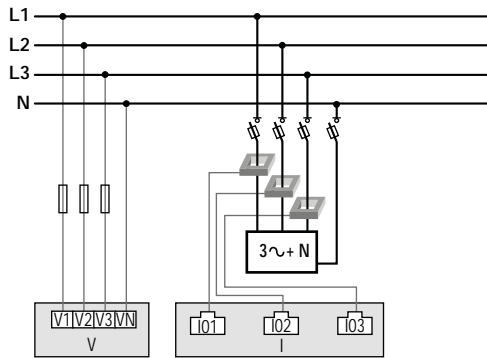

Three-phase

3P - 3CT (1 three-phase load)

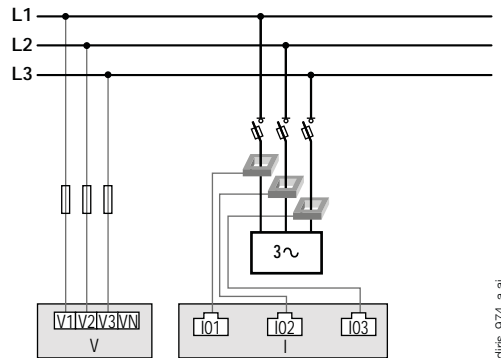

Three-phase

3P - 1CT (1 balanced three-phase load)

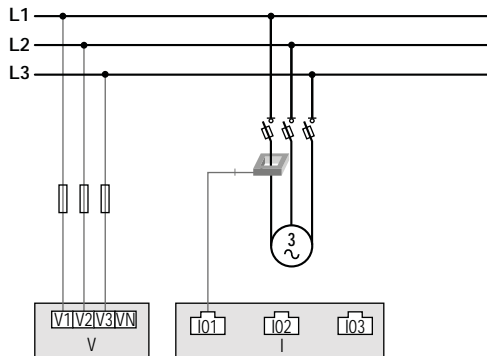

Single-phase

1P+N - 1CT (1 single-phase load)

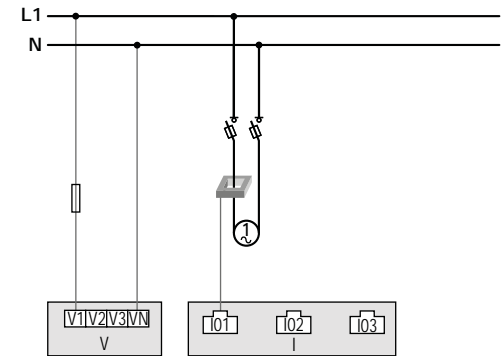

1. 0.5 A gG / 0.5 A class CC fuses.
 If self-supplied, a fuse must always be added to the Neutral.



DIRIS A-40 characteristics

Electrical characteristics

Auxiliary power supply	
Alternative voltage	110/400 VAC or 120/300 VDC - Cat III
Frequency	50/60 Hz
Power consumption	5VA AC / 1,5VA DC (48250500) 8VA AC / 2,5VA DC (48250501 & 48250502)
Connection	Removable spring-cage terminal block, 2x 2 positions, 0,5 - 2,5 mm ² solid cable or 0,25 - 1,5 mm ² stranded cable with end piece

Measurement characteristics

Power and energy measurement	
Accuracy	Class 0.2 DIRIS A-40 only
Active energy and active power	Class 0.5 with TE, TF or ITR sensors Class 1 with TR sensors
Accuracy of reactive energy	Class 2 with TE, TR/ITR or TF sensors

Power factor measurement	
Accuracy	Class 0.5 with TE, TF or ITR sensors Class 1 with TR sensors

Voltage measurement	
Characteristics of the network measured	50-300VAC (Ph/N) - 87-520VAC (Ph/Ph) - CAT III
Frequency range	45 to 65Hz
Frequency accuracy	Class 0.02
Network type	Single-phase/ Two-phase / Two-phase with neutral / Three-phase / Three-phase with neutral
Measurement by voltage transformer	Primary: 400 000 VAC Secondary: 60, 100, 110, 173, 190 VAC
Input consumption	≤ 0,1 VA
Accuracy of voltage measurement	Class 0.2
Connection	Removable spring-cage terminal block, 4 positions, 0,5 - 2,5 mm ² solid cable or 0,25 - 1,5 mm ² stranded cable with end piece

Current measurement	
Number of current inputs	3
Associated current sensors	Solid TE, split-core TR/ITR, flexible TF current sensors
Accuracy	0.2 DIRIS A-40 class only Class 0.5 with TE, TF or ITR sensors Class 1 with TR sensors
Connection	Specific Socomec cable with RJ12 connectors

Input characteristics

Number	3
Type / Power supply	Optocoupler with internal (12 VDC ± 10%) or external (12-24 VDC ± 20%) polarisation
Input function	Logic status, status of circuit breaker, synchronization topography, multifluid pulse metering
Connection	Removable screw terminal block, 5 positions, stranded or solid 0.14 - 1.5 mm ² cable

Output characteristics

Number	2
Type	Optocoupler 30 Vd.c. max 20mA max - SELV
Output function	Command, energy pulse output, load shedding, alarm
Connection	Removable screw terminal block, 4 positions, stranded or solid 0.14 - 1.5 mm ² cable

Communication characteristics

DIRIS A-40 RS485	
Link	RS485
Connection type	2 to 3 half duplex wires
Protocol	Modbus RTU
Baud rate	1200 to 115 200 baud
USB	Configuration of DIRIS A-40

References

DIRIS A-40 monitoring devices		Reference
DIRIS A-40	RS485 Modbus - 3 inputs / 2 outputs	4825 0500
DIRIS A-40	Ethernet Modbus TCP or BACnet IP - webserver - RS485 Modbus - 3 inputs / 2 outputs	4825 0501
DIRIS A-40	Profibus DPV1 - RS485 Modbus - 3 inputs / 2 outputs	4825 0502



DIRIS A60

Multifunction meters - PMD

energy monitoring and event analysis - dimensions 96 x 96 mm

Single-circuit metering,
measurement &
analysis



DIRIS A60

Principle diagram

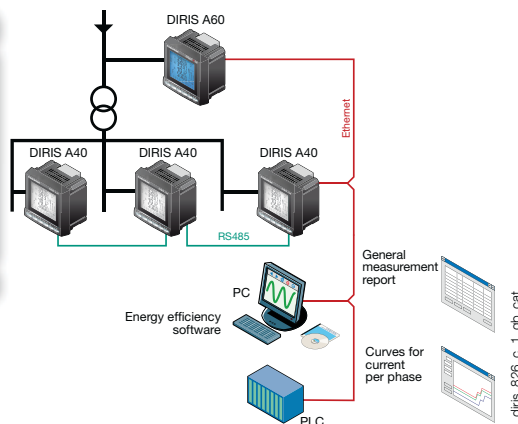

The solution for

- > Industry
- > Infrastructure
- > Data centre



Strong points

- > Easy to use
- > Detects wiring errors
- > Compliant with IEC 61557-12
- > Management softwares
- > Conformity to standard EN 50160

Conformity to standards

- > IEC 61557-12
- > IEC 62053-22 class 0.5S
- > IEC 62053-23 class 2
- > EN 50160



Function

DIRIS A60 is a panel mounted multifunction meter which incorporates all functions of the DIRIS A40 with the addition of enhanced data logging functions, recording curves for quality events. All this information can be analysed remotely using the Analysis software which is available at no charge and can be downloaded from the SOCOMEC website www.socomec.com.

Advantages

Easy to use

Thanks to its large backlit LCD display and its multiple viewing screens with direct key access, the DIRIS A60 provides clear readings and is easy to use.

It directly displays a number of multi-measurement and metering values : +/- kWh, +/- kvarh, kVAh, I, U, V, F, P, Q, S, PF, etc.

Detects wiring errors

An integrated test function can be utilised to detect incorrect wiring and to automatically correct CT installation errors.

Compliant with IEC 61557-12

IEC 61557-12 is a high-level standard for all PMDs (Performance Monitoring Devices) that are designed to measure and monitor electrical parameters in distribution networks.

Compliance with IEC 61557-12 ensures a high level of equipment performance, in terms of metrology, and the mechanical and environmental aspects (EMC, temperature, etc.).

Management softwares

- Optional Ethernet module with Webserver function: For measurement monitoring, data exploitation and the export of load curves remotely without a specific software (web browser access).
- Analysis software: For the analysis of events data in order to improve the reliability of the electrical installation.
- Easy Config software: For quick and easy remote device configuration; configuration files can be copied from and sent to the DIRIS A60, or they can be created without communication and sent at a later time. Multiple devices can be configured from a single file, which is especially useful for OEMs and panel builders.

Conformity to standard EN 50160

EN 50160 is a standard which defines events relating to the quality of electrical networks. The DIRIS A60 captures voltage events in accordance with this standard.

Functions

In addition to the functions of the DIRIS A40, the DIRIS A60 also:

- shows the current and voltage unbalance
- shows the tangent φ
- stores the load curves (60 days with an interval of 10 minutes) for the active, reactive and apparent power: ΣP +/-; ΣQ +/-; ΣS
- detects and stores the last 40 events concerning:
 - overvoltage
 - voltage dips
 - cut-offs
 - overcurrent.

For each stored event, the DIRIS A60 records the relevant RMS 10 ms interval curves for the voltages V1, V2, V3, U12, U23, U31 and the currents I1, I2, I3, In, giving a total of 400 curves.

Other functions:

Multi-measurement

Currents

- instantaneous: I1, I2, I3, In, Isystem,
- average/maximum average: I1, I2, I3, In,
- unbalance: I unb.
- Voltages & frequency
 - instantaneous: V1, V2, V3, U12, U23, U31, F, Vsystem, Usystem
 - average/maximum average: V1, V2, V3, U12, U23, U31, F
 - unbalance: U unb.
- Power
 - instantaneous: 3P, ΣP , 3Q, ΣQ , 3S, ΣS
 - maximum average: ΣP , ΣQ , ΣS
 - predictive: ΣP , ΣQ , ΣS .
- Power factor - PF, ΣPF
- Instantaneous total tangent φ
- Instantaneous, average and max. average unbalance

- Temperatures⁽¹⁾

- internal,
- external via 3 PT100 sensors

Metering

- Active energy: +/- kWh
- Reactive energy: +/- kvarh
- Apparent power: kVAh
- Hours: \odot

Harmonic analysis (level 63)

- Total harmonic distortion
 - Currents: thd I1, thd I2, thd I3, thd In
 - Phase-to-neutral voltage: thd V1, thd V2, thd V3
 - Phase-to-phase voltage: thd U12, thd U23, thd U31
- Individual
 - Currents: HI1, HI2, HI3, HIn
 - Phase-to-neutral voltage: HV1, HV2, HV3,
 - Phase to phase voltage: HU12, HU23, HU31

Events⁽¹⁾

- Alarms on all electrical values

Communications⁽¹⁾

- 0/4- 20 mA analogue output
- RS485 MODBUS RTU
- Ethernet (MODBUS TCP or MODBUS RTU over TCP and Webserver)
- Ethernet (MODBUS TCP or MODBUS RTU over TCP and Webserver) with RS485 MODBUS RTU gateway
- Inputs / Outputs⁽¹⁾
 - Pulse metering
 - Remote control/command
 - Alarm report
 - Pulse report

⁽¹⁾ Available as an option (see the following pages).

Front panel



1. Backlit LCD display.
2. Direct access key for currents, temperatures and test function.
3. Direct access key for voltages and frequency.
4. Direct access key for active, reactive, and apparent powers and power factor.
5. Direct access key for maximum and average current, voltage and power values.
6. Direct access key for harmonics values.
7. Direct access key for energies, hour meter and programming menu.

Plug-in modules

DIRIS® A60*



* With integrated memory module.



Pulse outputs

- 2 configurable pulse outputs (type, weight and duration) on \pm kWh, \pm kvarh and kVAh.



Communication MODBUS®

- RS485 link with MODBUS® protocol (speed up to 38400 bauds).



Ethernet communication

- Ethernet connection with MODBUS TCP or MODBUS RTU over TCP protocol.
- Embedded Webserver function⁽¹⁾.



Ethernet communication with RS485 MODBUS gateway

- Ethernet connection with MODBUS TCP or MODBUS RTU over TCP protocol.
- Connection of 1 to 247 RS485 MODBUS slaves.
- Embedded Webserver function⁽¹⁾.



Analogue outputs

- A maximum of 2 modules may be connected, providing up to 4 analogue outputs.
- Per module 2 outputs assignable to: 3I, In, 3V, 3U, F, \pm Σ P, \pm Σ Q, Σ S, Σ PFL/C, Isys, Vsys, Usys, Ppred, Q pred, Spred, T°C internal, T°C 1, T°C 2, T°C3 and to 30 VDC power supply.



2 inputs - 2 outputs

- A maximum of 3 modules may be connected, providing up to 6 inputs and 6 outputs.
- Per module 2 outputs assignable to:
 - monitoring: 3I, In, 3V, 3U, F, \pm Σ P, \pm Σ Q, Σ S, Σ PFL/C, THD 3I, THD In, THD 3V, THD 3U, Ppred, Qpred, Spred, T°C internal, T°C 1, T°C2, T°C3 and hour meter,
 - remote control,
 - timed remote control,
- 2 inputs for pulse metering.



Temperature⁽²⁾

- Temperature indication:
- Internal
 - External sensor PT 100 (T°C 1)
 - External sensor PT 100 (T°C 2)
 - External sensor PT 100 (T°C 3).

⁽¹⁾ See "Management softwares for DIRIS" p.150.

⁽²⁾ See "External sensor PT 100" in general catalog.

DIRIS A60

Multifunction meters - PMD

energy monitoring and event analysis - dimensions 96 x 96 mm

Accessories

Current transformers
(see page 128)



Split-core current transformers



IP65 protection



Panel mounting kit
for a 144 x 96 mm cut-out



Terminals

DIRIS A60

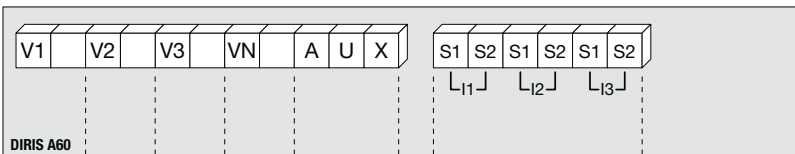

S1 - S2: current inputs

AUX: auxiliary power supplies U_s
V1 - V2 - V3 - VN: voltage inputs

RS485 MODBUS module

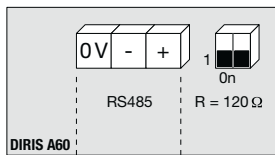

DIRIS A60

RS485 link.
R = 120 Ω : selectable internal resistance for RS485 end of line termination.

Ethernet module

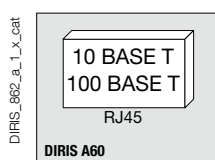

DIRIS A60

Ethernet module + RS485 MODBUS gateway

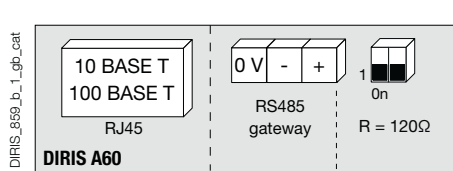

DIRIS A60

RS485 gateway resistor.
R = 120 Ω : selectable internal resistance for RS485 end of line termination.

Pulse output module

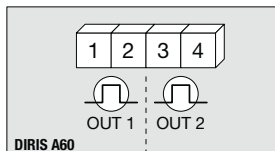

DIRIS A60

1 - 2: pulse output n°1.
3 - 4: pulse output n°2.

Temperature module

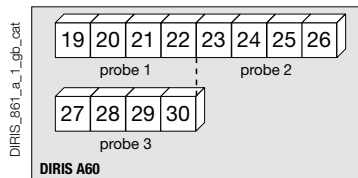

DIRIS A60

2 inputs / 2 outputs module

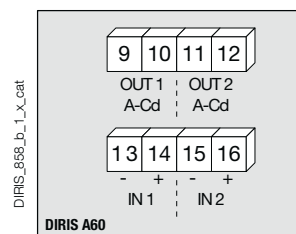

DIRIS A60

9 - 10: relay output n°1.
11 - 12: relay output n°2.
13 - 14: opto input n°1.
15 - 16: opto input n°2.

Analogue output module

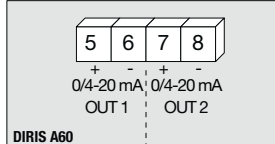

DIRIS A60

5 - 6: analogue output n°1.
7 - 8: analogue output n°2.

Electrical characteristics

Current measurement on insulated inputs (TRMS)	
Via CT primary	9 999 A
Via CT secondary	1 or 5
Measurement range	0 ... 11 kA
Input consumption	≤ 0.1 VA
Measurement updating period	1 s
Accuracy	0.2 %
Permanent overload	6 A
Intermittent overload	10 I _n for 1 s
Voltage measurements (TRMS)	
Direct measurement between phases	50 ... 700 VAC
Direct measurement between phase and neutral	28 ... 404 VAC
VT primary	500 000 VAC
VT secondary	60, 100, 110, 173, 190 VAC
Frequency	50 / 60 Hz
Input consumption	≤ 0.1 VA
Measurement updating period	1 s
Accuracy	0.2 %
Permanent overload	800 VAC
Current-voltage product	
Limitation for 1A CT	10 000 000
Limitation for 5A CT	10 000 000
Power measurement	
Measurement updating period	1 s
Accuracy	0.5 %
Power factor measurement	
Measurement updating period	1 s
Accuracy	0.5 %
Frequency measurement	
Measurement range	45 ... 65 Hz
Measurement updating period	1 s
Accuracy	0.1 %
Energy accuracy	
Active (according to IEC 62053-22)	Class 0.5 S
Reactive (according to IEC 62053-23)	Class 2
Auxiliary power supply	
Alternating voltage	110 ... 400 VAC
AC tolerance	± 10 %
Direct voltage	120 ... 350 VDC
DC tolerance	± 20 %
Frequency	50 / 60 Hz
Consumption	≤ 10 VA

2 inputs / 2 outputs module: Outputs (alarms / control)	
Number of relays	2 ⁽¹⁾
Type	250 VAC - 5 A - 1150 VA
2 inputs / 2 outputs module: Phototransistor inputs (pulse metering)	
Number	2 ⁽¹⁾
Power supply	10 ... 30 VDC
Minimum signal width	10 ms
Minimum duration between 2 pulses	18 ms
Type	phototransistors
Pulse output module	
Number of relays	2
Type	100 VDC - 0.5 A - 10 VA
Max. number of operations	≤ 10 ⁸
Analogue output module	
Number of outputs	2 ⁽²⁾
Type	insulated
Range	0 / 4 ... 20 mA
Load resistance	600 Ω
Maximum current	30 mA
MODBUS communication module	
Link	RS485
Type	2 ... 3 half duplex wires
Protocol	MODBUS RTU
MODBUS [®] speed	4800 ... 38400 bauds
Ethernet communication module	
Connection	RJ45
Speed	10 base T / 100 base T
Protocol	MODBUS TCP or MODBUS RTU over TCP
Temperature inputs	
Type	PT100
Connection	2, 3 or 4 wires
Dynamic	- 20 ... 150 °C
Accuracy	± 1 digit
Maximum length	300 cm
Operating conditions	
Operating temperature	- 10 ... + 55 °C
Storage temperature	- 20 ... + 85 °C
Relative humidity	95 %

(1) Max. 3 modules / DIRIS.

(2) Max. 2 modules / DIRIS.

Case

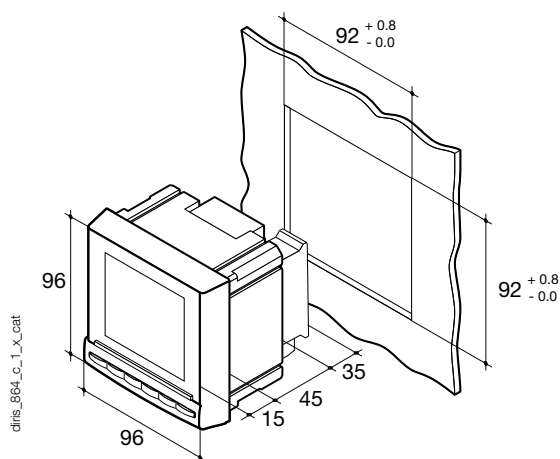

Type	panel mounting
Dimensions W x H x D	96 x 96 x 80 mm
Case degree of protection	IP30
Front degree of protection	IP52
Display type	backlit LCD display
Terminal blocks type	fixed or plug-in
Voltage and other terminals connection cross-section	0.2 ... 2.5 mm ²
Current connection cross-section	0.5 ... 6 mm ²
Weight	450 g

DIRIS A60

Multifunction meters - PMD

energy monitoring and event analysis - dimensions 96 x 96 mm

Connection

Low voltage balanced network for DIRIS A60

Recommendation: When disconnecting the DIRIS, the secondary of each current transformer must be short-circuited. This operation can be carried out automatically by a SOCOMEC PTI, which can be found in the SOCOMEC catalogue: please consult us.

3/4 wires with 1 CT

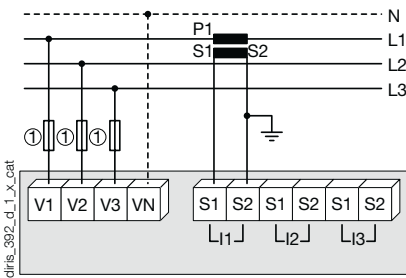

Use of 1 CT reduces by 0.5% the accuracy of the phases, the current of which is worked out by vector calculation.
1. Fuses 0.5 A gG / 0.5 A class CC.

Single-phase

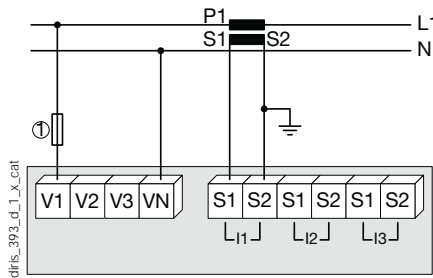

1. Fuses 0.5 A gG / 0.5 A class CC.

Two-phase

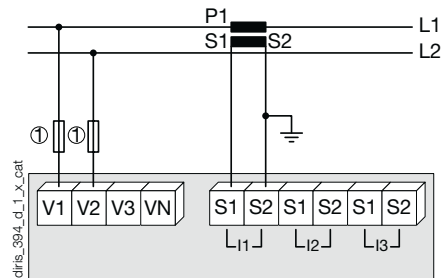

1. Fuses 0.5 A gG / 0.5 A class CC.

Low voltage unbalanced network for DIRIS A60

3/4 wires with 3 CTs

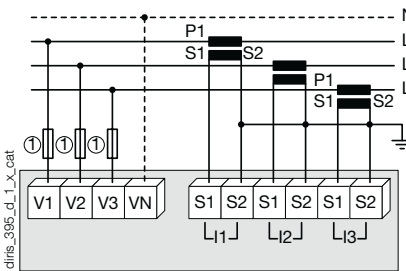

1. Fuses 0.5 A gG / 0.5 A class CC.

3 wires with 2 CTs

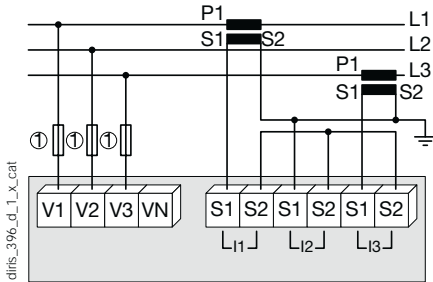

Use of 2 CTs reduces by 0.5% the accuracy of the phases, the current of which is worked out by vector calculation.
1. Fuses 0.5 A gG / 0.5 A class CC.

3 wires with 2 CTs

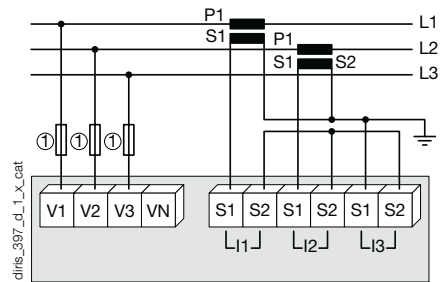

Use of 2 CTs reduces by 0.5% the accuracy of the phases, the current of which is worked out by vector calculation.
1. Fuses 0.5 A gG / 0.5 A class CC.

Additional information

Communication via RS485 link

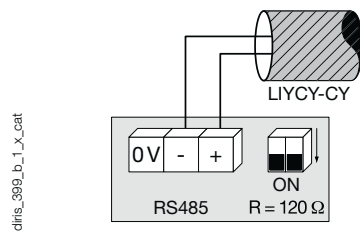

diris_399_b_1_x_cat

Connection of voltage transformer for HV networks

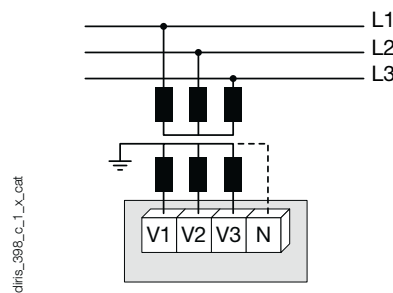

diris_398_c_1_x_cat

AC & DC auxiliary power supply

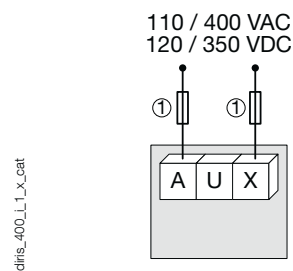

diris_400_l_1_x_cat

1. Fuses 0.5 A gG / 0.5 A class CC.

References

Basic device	DIRIS A60
Auxiliary power supply U_s	Reference
110 ... 400 VAC / 120 ... 350 VDC	4825 0207
Options	
Plug-in-modules⁽¹⁾	Reference
Pulse outputs	4825 0090
RS485 MODBUS [®] communication	4825 0092
Analogue outputs	4825 0093
2 inputs / 2 outputs	4825 0094
Ethernet communication (embedded Ethernet Webserver) ⁽²⁾	4825 0203
Ethernet communication + RS485 MODBUS gateway (embedded Ethernet Webserver) ⁽²⁾	4825 0204
Temperature inputs	4825 0206

(1) Easy integration of additional functions (maximum 3 slots per device).

(2) Dimension of the plug-in module: 2 slots.

Options	To be ordered in multiples of	Reference
Description of accessories		
IP65 protection	1	4825 0089
Panel mounting kit for a 144 x 96 mm cut-out	1	4825 0088
Fuse disconnect switches for the protection of voltage inputs (type RM) 3 poles	4	5601 0018
Fuse disconnect switches for the protection of the auxiliary supply (type RM) 1 pole + neutral	6	5601 0017
Fuse type gG 10 x 38 0.5 A	10	6012 0000
Ferrite to be associated with communication modules	1	4899 0011
Current transformer range	1	See page 128
Temperature sensor PT100 - M6 screw type	1	4825 0208
Temperature sensor PT100 - M6 eyelet type	1	4825 0209
Management softwares for DIRIS		See page 150

Expert Services

- > Study, definition, advice, implementation, maintenance and training...
Our experts "Expert Services" offer complete support for the success of your project.





DIRIS B

Multifunction power monitoring devices

Measurement & wireless metering



Configuration with EasyConfig.

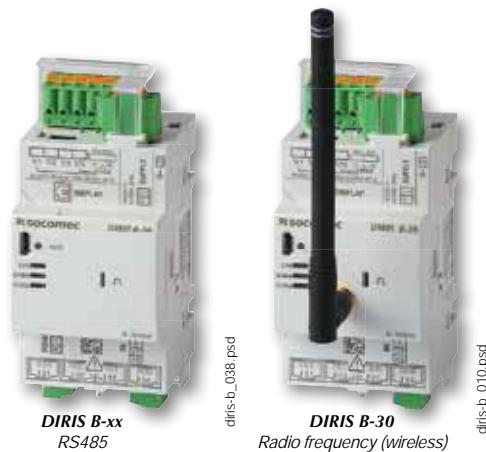

DIRIS B-xx
RS485

diris-b_038.psd

DIRIS B-30
Radio frequency (wireless)

diris-b_010.psd

The solution for

- > Industry
- > Building
- > Infrastructure
- > Local authority



Strong points

- > Plug & Play
- > Global accuracy class 0.5 in accordance with IEC 61557-12
- > Multi-circuit
- > Communication

Integrated technologies



For more information see our website www.socomec.com

Conformity to standards

- > UL E257746
- > IEC 61557-12
- > EN 50160
- > ISO 14025



Function

The DIRIS B is a power monitoring device in a modular format that communicates wirelessly (DIRIS B-30 RF only) or via RS485. The 4 RJ12 independent current inputs of the device allow it to manage several types and number of circuits: for example, 4 single-phase loads or 1 three-phase load + 1 single-phase load.

The DIRIS B is connected to current sensors (RJ12 connection) that are suitable for all types of installation: solid TE, split-core TR/ITR, and flexible TF current sensors.

Advantages

Plug & Play

A rapid RJ12 connection makes wiring easy and reliable and prevents wiring errors. Automatically addressing and configuring the product (communication address, load type, type and ratio of current sensor) allow you to simplify implementation and to save time.

Class 0.5 in accordance with IEC 61557-12



- Class 0.2 for the meter alone.
- Class 0.5 from 2% to 120% of nominal current for the global measurement chain (associated with TE/ITR/TF current sensors).

Multi-circuit

- 4 current measurement inputs allow you to configure multiple circuits in order to optimise the number of measurement devices per installation.

Communication

- The DIRIS B can be connected to:
 - a remote DIRIS D-30 screen for displaying measurement and metering data.
 - a DIRIS G gateway for centralisation and communication of data wirelessly or via RS485 and Ethernet.
 - optional modules to communicate in BACnet IP, BACnet MSTP and PROFIBUS DP protocol. Digital or analogue input/output modules can also be connected.

Application	Local metering	Local analysis	Remote analysis
			
DIRIS B	B-10 RS485	B-30 RS485	B-30 RF
Number of current inputs	4	4	4
Metering			
± kWh, ± kvarh, kVAh	•	•	•
Load curves		•	•
Multi-tariff	•	•	•
Multi-measurement			
U12, U23, U31, V1, V2, V3, f	•	•	•
U system, V system	•	•	•
I1, I2, I3, In, ΣP, ΣQ, ΣS, ΣPF	•	•	•
P, Q, S, PF per phase	•	•	•
Predictive power	•	•	•
Ph/N unbalance	•	•	•
Ph/Ph unbalance	•	•	•
Current unbalance (Inba, Idir, linv, lhom, lnb)	•	•	•
Phi, cos Phi, tan Phi	•	•	•
Quality analysis			
THDv1, THDv2, THDv3, THDu12, THDu23, THDu31	•	•	•
THDi1, THDi2, THDi3, THDin	•	•	•
Individual harmonics U & V (up to 63rd)		•	•
Individual harmonics I (up to 63rd)		•	•
Crest factor I1, I2, I3, In		•	•
Crest factor V1, V2, V3, U12, U23, U31		•	•
Voltage dips, interruptions, swells (EN 50160)		•	•
Overcurrents		•	•
Alarms			
On threshold		•	•
Inputs/outputs		•	•
History of average values			
45 days (max)		•	•
Communication			
RS485 Modbus	•	•	
868 Mhz radio-frequency			•
2 inputs (status/pulse)	•	•	•

Accessories

DIRIS B sealing cover

- Prevents access to the cabling of the monitoring device.



Remote radio antenna

- Mounted outside the enclosure of the DIRIS B-30 monitoring device to increase the transmission distance.

USB configuration cable (2 m)

- Advanced configuration of DIRIS B gateways can be achieved using the EASY CONFIG software via Ethernet or direct USB connection.

DIRIS B

Multifunction power monitoring devices

DIRIS D-30 display

DIRIS D-30

Connection



diris-d_001_a_1_cat

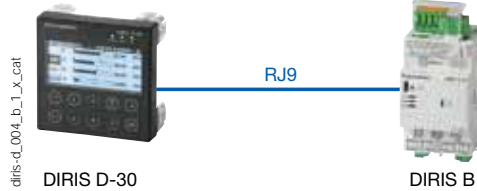

Optional modules

DIRIS O



diris-b_031_a

Optional module

DIRIS B



Optional modules (4 max.)*

- Digital inputs/outputs
- Analogue inputs/outputs
- Temperature inputs
- Communication protocols

* maximum 4 optional modules with maximum 1 temperature module and 1 communication module (Modbus, PROFIBUS, BACnet IP or BACnet MSTP).



diris-o_019_a

DIRIS O-iod

- 2 digital inputs centralises the metering pulses or the input status changes of the auxiliary contacts.
- 2 digital outputs can be connected to configurable alarms warning of exceeded thresholds (power, current, etc.) or can be piloted remotely.



diris-o_024_a

DIRIS O-m

- Provides a second RS485 Modbus communication port to the DIRIS B for simultaneous sending of information via RS485 to two supervision stations.



diris-o_018_a

DIRIS O-ioa

- 2 inputs (4-20 mA) centralise analogue sensors (pressure, humidity, temperature, etc.)
- 2 outputs (4-20 mA) report the measurements (power, currents, etc.) to PLCs.



diris-o_023_a

DIRIS O-p

- Adds a PROFIBUS DPV1 communication port to the DIRIS B.



diris-o_020_a

DIRIS O-it

- 3 temperature inputs to be connected to PT100 or PT1000 sensors.
- Ambient air temperature:



diris-o_022_a

DIRIS O-b/ip

- Adds a BACnet IP communication port to the DIRIS B.



diris-o_021_a

DIRIS O-b/mstp

- Adds a BACnet MSTP communication port to the DIRIS B.

DIRIS B terminals

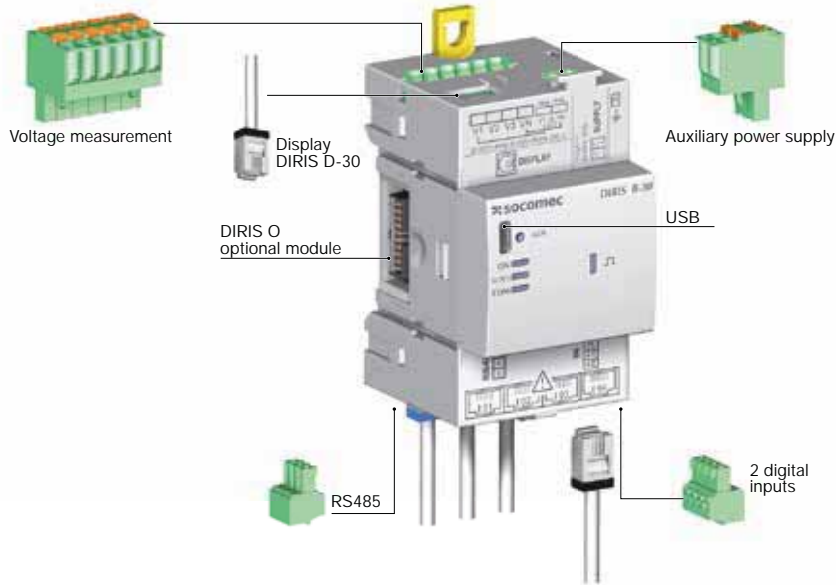

dfiris-d_027_b_1_gb_cat

Current measurement

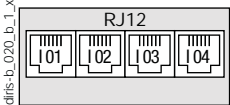

Voltage measurement and auxiliary power supply

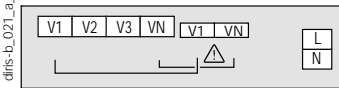

2 inputs supplied by the product

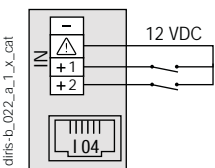

dfiris-b_021_a_1_x_cat

Self supply

Easy connection of the power supply from the measurement terminal (specific terminals)

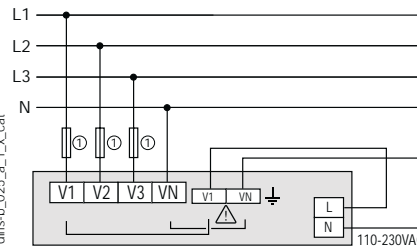

1. Fuses 0.5 A gG / 0.5 A class CC.

2 inputs with external power supply

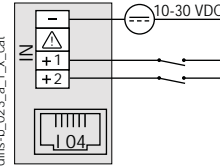

dfiris-b_025_a_1_x_cat

Separate power supply

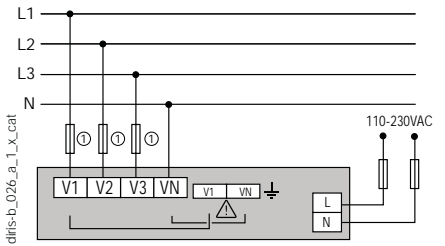

1. Fuses 0.5 A gG / 0.5 A class CC.

RS485

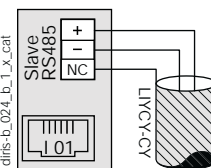

dfiris-b_026_a_1_x_cat

RJ9 for DIRIS D-30 (self-supply and data)



dfiris-b_026_b_1_x_cat

Terminals of optional DIRIS O modules

Optional module power supply

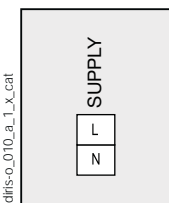

dfiris-o_010_a_1_x_cat

DIRIS O-iod

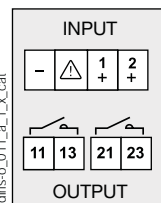

dfiris-o_011_a_1_x_cat

DIRIS O-ioa

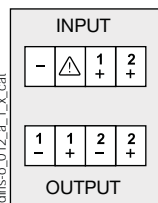

dfiris-o_012_a_1_x_cat

DIRIS O-it

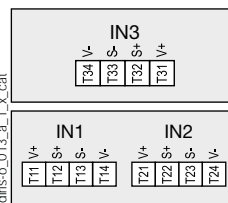

dfiris-o_013_a_1_x_cat

DIRIS O-m RS485

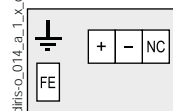

dfiris-o_014_a_1_x_cat

DIRIS O-p

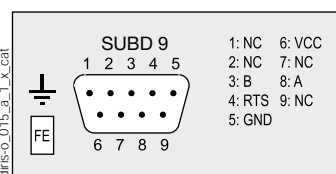

dfiris-o_015_a_1_x_cat

DIRIS O-b/ip

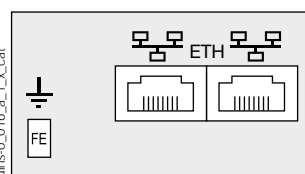

dfiris-o_016_a_1_x_cat

DIRIS O-b/mstp

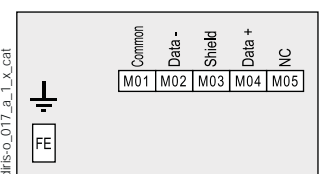

dfiris-o_017_a_1_x_cat

Connections

Associated current sensors

Various types of current sensors can be connected to the DIRIS B: Solid TE, split-core TR/iTR, flexible TF current sensors. This range of sensors can be adapted to all types of new or existing installations. A rapid RJ12 connection makes wiring easy and reliable and prevents wiring errors. The DIRIS B automatically recognises the type of sensor used and its current rating. This guarantees the overall accuracy of the DIRIS B + current sensor measurement chain.
 For more information: see "TE sensors" pages.

TE solid current sensors

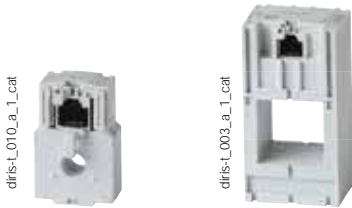

TR/iTR Split-core current sensors TF Flexible current sensors

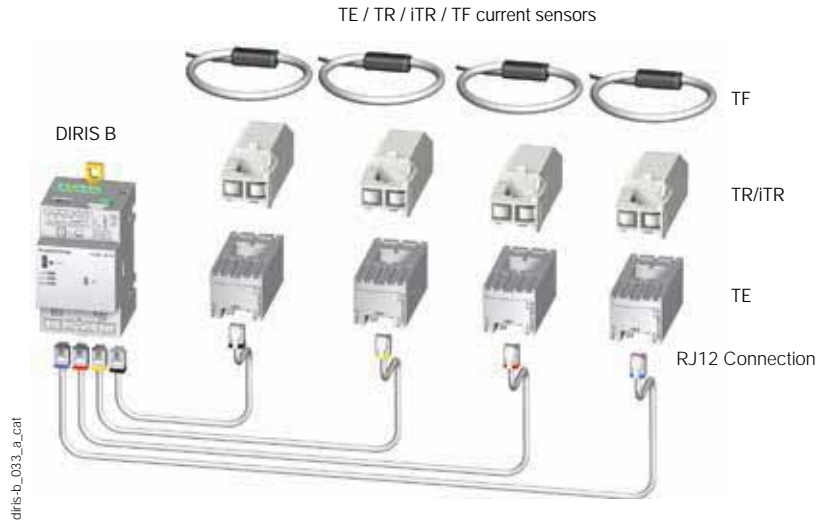

Network and connection examples

Three phase + neutral

3P+N - 4 CTs (measurement for 1 three-phase load + Neutral)

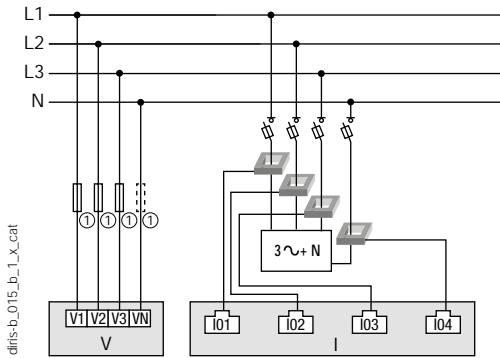

Three-phase

3P - 2 CTs (2 three-phase loads without neutral)

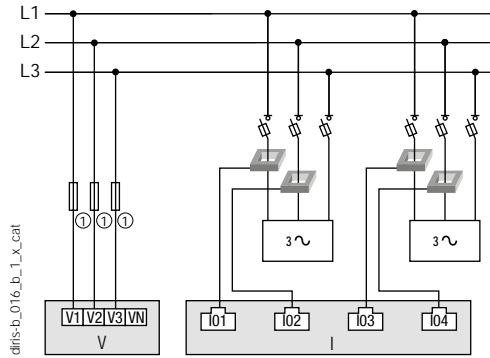

Three-phase

3P+N - 3 CTs & 1P+N - 1 CT (1 three-phase load & 1 single-phase load)

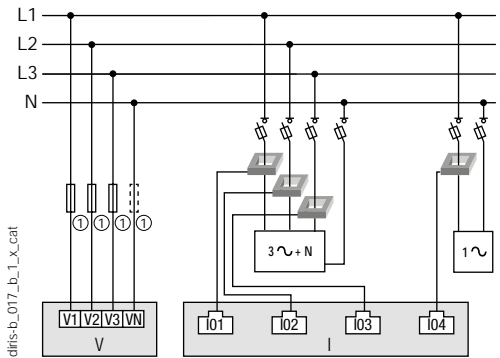

Single-phase

1P+N-1CT (4 single-phase loads)

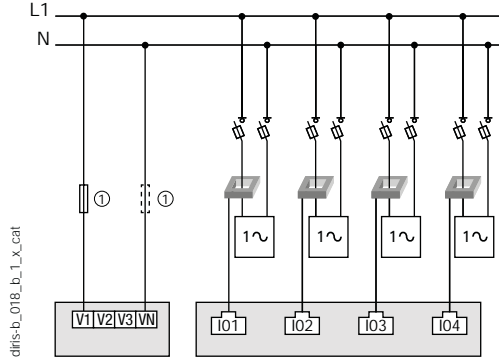

1. Fuses 0.5 A gG / 0.5 A class CC.
 In case of self-supply, a fuse must be added on the neutral.



Dimensions (mm)

DIRIS B

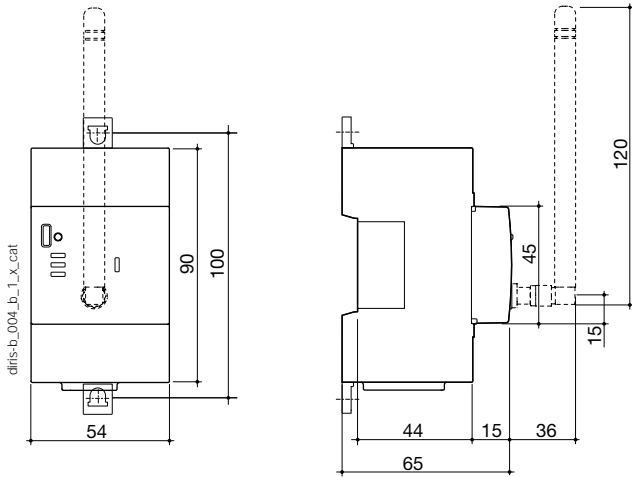

DIRIS O optional modules

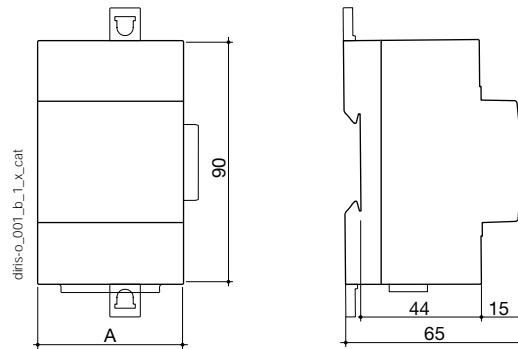

DIRIS O optional modules	A
DIRIS O-iod - DIRIS O-ioa - DIRIS O-it	45 mm
DIRIS O-m - DIRIS O-p - DIRIS O-b/ip - DIRIS O-b/mstp	54 mm

DIRIS D-30

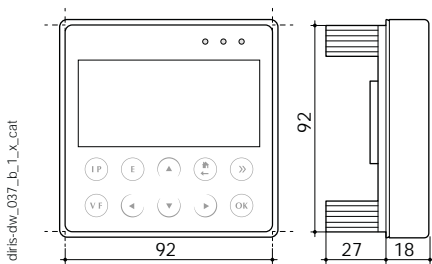

Communication architecture

Example of communication architecture with DIRIS G gateway and WEBVIEW embedded WEB server
For more information about DIRIS G, see "DIRIS G" pages.

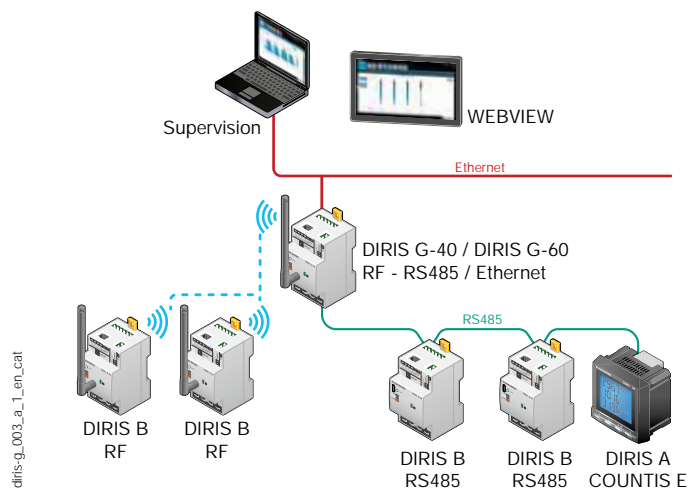

DIRIS B characteristics

Electrical characteristics

Auxiliary power supply	
AC voltage	110-230VAC ±15 % (Ph/N ou Ph/Ph) Cat III
Frequency	50/60 Hz
Consumption	< 2VA without display < 6VA with display
Connection	Removable spring-cage terminal, 2 x 2 positions, 0.5 ... 2.5 mm ² solid cable or 0.25 ... 1.5 mm ² stranded cable with ferrule

Measurement characteristics

Energy and power measurement	
Accuracy	Class 0.2 DIRIS B alone
Active energy and active power	Class 0.5 with TE or TF current sensors Class 1 with TR current sensors
Reactive energy accuracy	Class 2 with TE, TR or TF current sensors

Power factor measurement	
Accuracy	Class 0.5 with TE or TF current sensors Class 1 with TR current sensors

Voltage measurement	
Network characteristics measured	50-300VAC (Ph/N) - 87-520VAC (Ph/Ph) - CAT III
Frequency range	45 ... 65Hz
Frequency accuracy	Class 0.02
Network type	Single-phase / Two-phase / Two-phase with neutral / Three-phase / Three-phase with neutral
Measurement by voltage transformer	Primary: 400 000 VAC Secondary: 60, 100, 110, 173, 190 VAC
Input consumption	≤ 0.1 VA
Permanent overload	300VAC Ph/N
Voltage measurement accuracy	Class 0.2
Connection	Removable spring-cage terminal, 2 x 6 positions, 0.5 ... 2.5 mm ² solid cable or 0.25 ... 1.5 mm ² stranded cable with ferrule

Current measurement	
Number of current inputs	4
Associated current sensors	Solid TE , split-core TR/iTR , flexible TF current sensors
Accuracy	Class 0.2 DIRIS B alone Class 0.5 with TE or TF current sensors Class 1 with TR current sensors
Connection	RJ12 connectors with specific SOCOMEC cable

Input characteristics

Number	2
Type / Power supply	Optocoupler internal polarisation (12 VDC ± 10 %) or external polarisation (10-30 VDC ± 10%)
Input function	Logic status, pulse meter or synchronisation pulse status (input 1)

Communication characteristics

DIRIS B RS485	
Link	RS485
Connection type	2 ... 3 half duplex wires
Protocol	Modbus RTU
Speed	1200 ... 115200 bauds
USB	DIRIS B RS485 configuration

DIRIS B-30 RF	
Link	Wireless radio frequency
Frequency band	868 MHz (low frequency: 868.1 MHz and high frequency: 869.5875 MHz)
Speed	38400 bauds
USB	DIRIS B-30 RF configuration

Environment characteristics

Operating temperature	-10 ... +70 °C
Storage temperature	-25 ... +85 °C
Operating humidity	55 °C / 97% relative humidity
Operating altitude	2000 m
Vibration	1G from 10 Hz to 100Hz

DIRIS D-30 display characteristics

Mechanical characteristics	
Screen type	Capacitive touch-screen technology, 10 keys
Screen resolution	350 x 160 pixels
Single product connection	
RJ9	Self-supply and data
Micro-USB	Updating
Degree of protection	IP65 (front face)
Environment	
Storage temperature (°C)	-20 ... +70°C
Operating temperature (°C)	-20 ... +70°C
Humidity	95 % to 40°C
Installation category	CAT III
Degree of pollution	2

DIRIS O optional modules characteristics

Power supply ⁽¹⁾	
AC voltage	110-230 VAC ±15 %
Frequency	50/60 Hz

(1) No power supply on DIRIS O-it.

DIRIS O-iod - 2 digital inputs/2 digital outputs	
Number of inputs	2 per optional modules - max. 4 optional modules
Type	Optocoupler internal polarisation (12 VDC ± 10 %) or external polarisation (10-30 VDC ± 10%)
Function	Logic status or pulse meter
Number of outputs	2 per optional modules - max. 4 optional modules
Type	Relay / 230VAC ±15 % - 1 A
Function	Configurable alarm (current, power,...) on threshold overruns or remote controlled status
Inputs/Outputs connection	Removable screw terminal, 4 positions, 0.14 to 1.5 mm ² stranded or solid cable

DIRIS O-ioa - 2 analogue inputs/2 analogue outputs	
Number of inputs	2 per optional modules - max. 4 optional modules
Type	4-20 mA
Function	Connection of analogue sensors (pressure, humidity, temperature...)
Number of outputs	2 per optional modules - max. 4 optional modules
Type	4-20 mA
Function	Transmission of measurement image (current, power...) to PLCs

DIRIS O-it - 3 temperature inputs	
Number of inputs	3 external inputs + 1 measurement for ambient temperature
Dynamic	-20 °C to 150 °C
Type	PT100 or PT1000
Function inputs 1, 2 and 3	Temperature measurement

DIRIS O-m - RS485 communication	
Link	RS485 2 ... 3 half duplex wires
Protocol	Modbus RTU
Speed	1200 ... 115200 bauds
Connection	Removable screw terminal, 3 positions, 0.14 to 1.5 mm ² stranded or solid cable

DIRIS O-p - PROFIBUS communication	
Protocol	PROFIBUS DPV1

DIRIS O-b/ip - BACnet IP communication	
Protocol	BACnet IP
Speed	10 ... 100 Mbit/s

DIRIS O-b/mstp - BACnet MSTP communication	
Protocol	BACnet MSTP
Speed	9600 ... 76800 bauds

References

DIRIS B monitoring devices		Reference
DIRIS B-10	RS485 - Modbus - 230 VAC	4829 0010
DIRIS B-30	RS485 - Modbus - 230 VAC	4829 0000
DIRIS B-30	RF - Modbus - 230 VAC	4829 0002

DIRIS O optional modules		Reference
DIRIS O-iod	2 digital inputs / 2 digital outputs	4829 0030
DIRIS O-ioa	2 analogue inputs/2 analogue outputs 4-20 mA	4829 0031
DIRIS O-it	3 temperature inputs PT 100 / PT 1000	4829 0032
DIRIS O-m	RS485 Modbus communication	4829 0033
DIRIS O-p	PROFIBUS communication	4829 0034
DIRIS O-b/ip	BACnet IP communication	4829 0035
DIRIS O-b/mstp	BACnet MSTP communication	4829 0036

Accessories		Reference
DIRIS D-30 - Single-point display		4829 0200
RJ9 cable for DIRIS D-30 display - 1.5 m		4829 0280
RJ9 cable for DIRIS D-30 display - 3 m		4829 0281
Wireless remote antenna, 868 MHz - 210 mm height		4854 0126
Cable for remote antenna - SMA connector - 3 meter length		4854 0127
DIRIS B-30 sealing cover for I/O terminals		4829 0049
USB configuration cable		4829 0050



COUNTIS E0x

Active energy meters
single-phase - direct 40 A

Single-circuit metering,
measurement &
analysis



COUNTIS E04 - MID

The solution for

- > Industry
- > Marinas
- > Shopping centers
- > Data center
- > Camping
- > EV Chargers



Strong points

- > Compactness
- > Output (pulses)
- > MID certified B+D module
- > RS485 (MODBUS) and M-Bus communication
- > Multi-measurement
- > Bi-directional metering

MID certification

- > COUNTIS E units comply with the MID directive to guarantee accuracy and reliability when metering, compulsory for energy billing applications.
- > COUNTIS E MID feature tamper-proof components to prevent fraud.



Conformity to standards

- > IEC 62053-21 class 1
- > IEC 62053-23 class 2
- > IEC 62053-31
- > IEC 62052-11
- > EN 50470-1
- > EN 50470-3



Function

The COUNTIS E0x is a modular energy meter displaying energies (kWh and kVarh) and other measurements directly on its backlit LCD display, allowing direct connection up to 40 A. COUNTIS E02, E04 and E06 are also MID-certified.

Advantages

Compactness

Only 1 module wide.

Output (pulses)

The pulse output enables the kWh consumption to be reported to a remote system (PC/BMS) so that it can be analysed for billing, energy saving or energy cost management purposes.

MID certified B+D module

COUNTIS E units comply with the MID directive to guarantee accuracy and reliability when metering, compulsory for energy billing applications. "Module B+D" certification guarantees that the design and manufacturing process of products are approved by an accredited laboratory.

Functional diagram

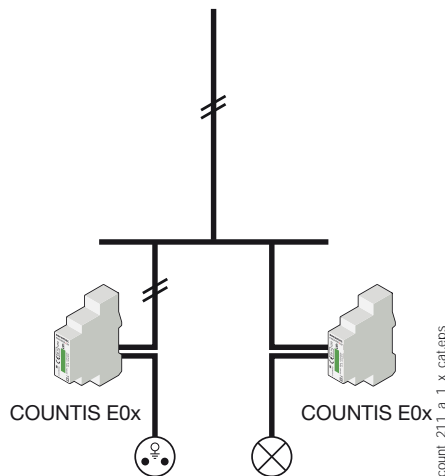

Common characteristics

- Compact dimensions.
- Measurement accuracy: 1%.
- Displayed on backlit screen.
- Multi-measurement available on display.

Models	Model-related specifications
E00	Pulse output
E02	Pulse output + MID
E03	Dual tariff + Pulse output + RS485 MODBUS communication
E04	Dual tariff + Pulse output + RS485 MODBUS communication + MID
E05	Dual tariff + Pulse output + M-Bus communication
E06	Dual tariff + Pulse output + M-Bus communication + MID

Front panel

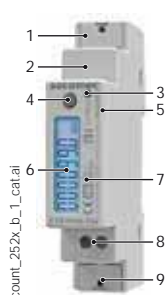

1. Neutral terminal and terminal shrouds (COUNTIS E02/E04/E06).
2. M-Bus/MODBUS connection.
3. Metrological LED.
4. Navigation button.
5. Serial number.
6. Backlit LCD display.
7. MID marking (COUNTIS E02/E04/E06).
8. Pulse output.
9. Current and voltage terminals.

Dimensions (mm)

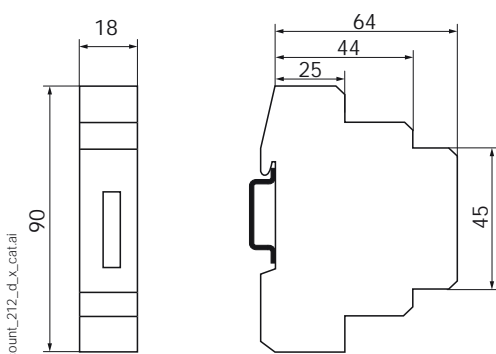

Type	modular
Number of modules	1
Dimensions W x H x D (mm)	18 x 90 x 64
Case degree of protection	IP 20
Front degree of protection	IP 51 ⁽¹⁾
Display type	7 digit LCD with backlighting
Rigid cable cross-section	1.5 ... 6 mm ²
Flexible cable cross-section	1.5 ... 6 mm ²
Weight	100 g E03/E04 80 g E00/E02/E05/E06

(1) For the installation in a cabinet at least with IP51 protection.

Electrical characteristics

Current measurement (TRMS)		
Type	single phase - direct 40 A	
Input consumption	max 0.5 VA	
Permanent overload	40 A	
Intermittent overload	30 I _{max} over 10 ms	
Startup current (I _{st})	20 mA	
Minimum current (I _{min})	0.25 A	
Transition current (I _{tr})	0.5 A	
Reference current (I _{ref})	5 A	
Voltage measurements (TRMS)		
Range of measurement	184 ... 276 VAC	
Input consumption	Max. 1.5 VA for E00/E02/E03/E04 Max. 1 VA for E05/E06	
Permanent overload	280 VAC	
Energy accuracy		
Active (according to IEC 62053-21)	Class 1	
Active (according to EN 50470)	Class B	
Reactive (according to IEC 62053-22)	Class 2	
Power supply		
Self-powered	yes	
Frequency	50/60 Hz	
Output (pulses)		
Number	1	
Type of optocoupler	27 VDC - 27 mA (IEC 62053-31)	
Fixed pulse weight	100 Wh	
Pulse duration	100 ms	
Operating conditions		
Operating temperature	-25 ... +55°C	
Storage temperature	-40 ... +75°C	
Relative humidity	80%	
Communication		
	COUNTIS E03/E04	COUNTIS E05/E06
Link	RS485	Wired
Type	2 ... 3 half duplex wires	2 half duplex
Protocol	MODBUS in RTU mode	M-Bus
Speed	2400 ... 38400 bauds	300, 2400, 9600 bps

Terminals and connections

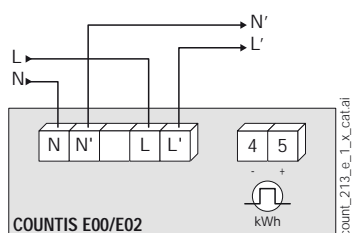

N - L: network input.

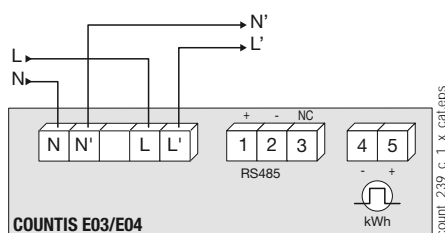

N' - L': network output.

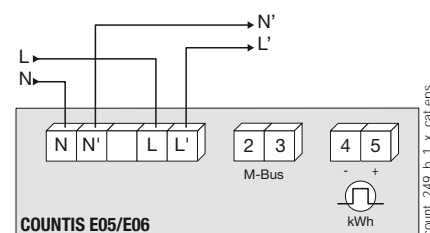

References

Type	COUNTIS E00 Reference	COUNTIS E02 Reference	COUNTIS E03 Reference	COUNTIS E04 Reference	COUNTIS E05 Reference	COUNTIS E06 Reference
Direct 40 A	4850 3058					
Direct 40 A - MID		4850 3059				
Direct 40 A - Dual tariff + RS485 MODBUS communication			4850 3039			
Direct 40 A - Dual tariff + RS485 MODBUS communication + MID				4850 3040		
Direct 40 A - Dual tariff + M-Bus communication					4850 3041	
Direct 40 A - Dual tariff + M-Bus communication + MID						4850 3042



COUNTIS E1x

Active-energy meters
single-phase - direct 80 A

Single-circuit metering,
measurement &
analysis



COUNTIS E14 - MID

Function

The **COUNTIS E1x** is a modular energy meter displaying the energies (kWh, kVAh and kVA) and other measurements directly on its backlit LCD display. It is designed for single-phase load metering and is used for direct connections of up to 80 A.

Advantages

RS485 (MODBUS), M-Bus communication, Ethernet or pulse outputs

To easily centralise your consumption, COUNTIS E1x devices have either one pulse output, one RS485 output (MODBUS), M-Bus or Ethernet Modbus TCP communication. With RS485 and Ethernet communication models, you can configure your meters remotely.

Multi-tariff

Lets you assign different time slots (every hour, dip times) or different sources (normal, back-up) to your energy readings to monitor your energy consumption in more detail.

MID certified B+D module

COUNTIS E units comply with the MID directive to guarantee accuracy and reliability when metering, compulsory for energy billing applications. "Module B+D" certification guarantees that the design and manufacturing process of products are approved by an accredited laboratory.

Functional diagram

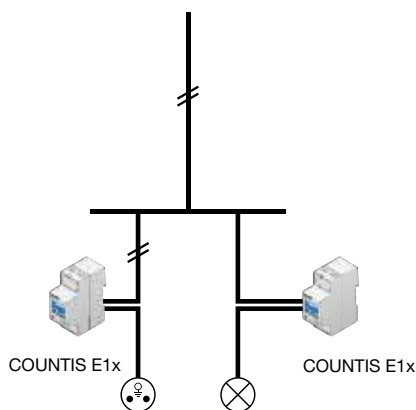

Common characteristics

- Measurement accuracy: 1%.
- Displayed on backlit screen.
- Multi-measurement available on display.
- Compact dimensions.

The solution for

- > Marinas
- > Shopping centers
- > Data centers
- > Industry
- > EV Chargers
- > Camping



Strong points

- > Compactness
- > Multi-measurement
- > Bi-directional metering
- > RS485 (MODBUS), M-Bus communication, Ethernet or pulse outputs
- > Multi-tariff
- > MID certified B+D module

MID certification

- > COUNTIS E units comply with the MID directive to guarantee accuracy and reliability when metering, compulsory for energy billing applications.
- > COUNTIS E MID feature tamper-proof components to prevent fraud.



Conformity to standards

- > IEC 62053-21 class 1
- > IEC 62053-23 class 2
- > IEC 62053-31
- > IEC 62052-11
- > EN 50470-1
- > EN 50470-3



Models	Model-related specifications
E11	Dual tariff + pulse output
E12	Dual tariff + pulse output + MID
E13	Dual tariff + pulse output + MODBUS RS485 communication
E14	Dual tariff + pulse output + MODBUS RS485 communication + MID
E15	Dual tariff + pulse output + M-BUS communication
E16	Dual tariff+ pulse output + M-BUS communication + MID
E17	Dual tariff + Ethernet
E18	Dual tariff + Ethernet + MID

Front panel

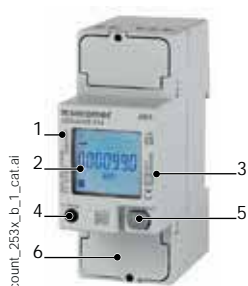

1. Serial number.
2. Backlit LCD display.
3. MID marking (COUNTIS E12/E14/E16/E18).
4. Metrological LED.
5. Navigation button.
6. Voltage, current, neutral terminals and terminal shrouds (COUNTIS E12/E14/E16/E18).

Dimensions (mm)

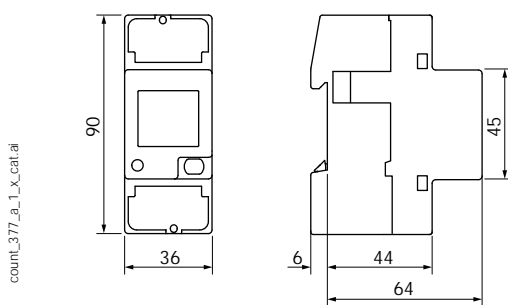

Type	modular
Number of modules	2
Dimensions W x H x D	36 x 90 x 64 mm
Case degree of protection	IP 20
Front degree of protection	IP 51 ⁽¹⁾
Display type	backlit LCD
Rigid cable cross-section	1.5 ... 35 mm ²
Flexible cable cross-section	1.5 ... 35 mm ²
Weight	215 g E13/E14/E17/E18 205 g E11/E12/E15/E16

(1) For the installation in a cabinet at least with IP51 protection.

Electrical characteristics

Measurement of currents			
Type	single phase - direct 80 A		
Input consumption	max. 0.5 VA		
Startup current (I _{st})	20 mA		
Minimum current (I _{min})	0.25 A		
Transition current (I _{tr})	0.5 A		
Reference current (I _{ref})	5 A		
Permanent overload (I _{max})	80 A		
Intermittent overload	30 I _{max} over 10 ms		
Voltage measurement			
Range of measurement	230 ... 240 V ± 20%		
Consumption (VA)	3.5 VA max E13/E14/E17/E18 7.5 VA max E11/E12/E15/E16		
Permanent overload	290 V phase-neutral		
Energy accuracy			
Active (according to IEC 62053-21)	Class 1		
Active (according to EN 50470)	Class B		
Reactive (according to IEC 62053-22)	Class 2		
Power supply			
Self-powered	Yes		
Frequency	50/60 Hz		
Output (pulses)			
Optocoupler type (IEC 62053-31)	250 VAC/DC - 100 mA (E11/E12) 27 VDC - 27 mA (E13/E14/E15/E16)		
Number	1		
Fixed pulse weight	100 Wh		
Pulse duration	50 ± 2 ms ON time 30 ± 2 ms OFF time		
Operating conditions			
Operating temperature	-25 ... 55°C		
Storage temperature	-25 ... 75°C		
Relative humidity	80%		
Communication			
	COUNTIS E13/14	COUNTIS E15/E16	COUNTIS E17/E18
Link	RS485	Wired	RJ45
Type	2 half duplex 2-3 half duplex (E13/E14)		Full duplex
Protocol	MODBUS® RTU	M-BUS	MODBUS TCP, HTTP, NTP, DHCP
Baudrate	1200 ... 115200 bauds	300 ... 9600 bauds	10/100 Mbps

Connection

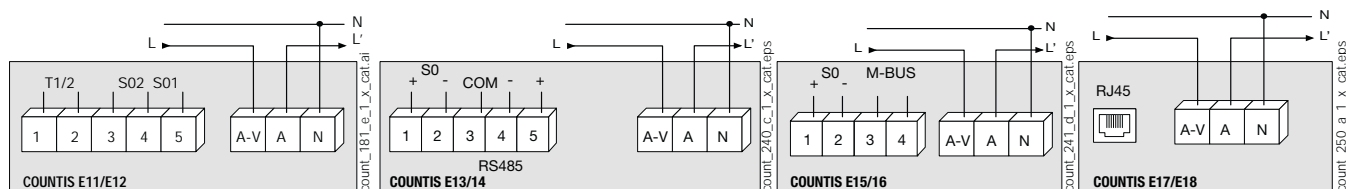

References

Type	COUNTIS E11	COUNTIS E12	COUNTIS E13	COUNTIS E14	COUNTIS E15	COUNTIS E16	COUNTIS E17	COUNTIS E18
	Reference	Reference	Reference	Reference	Reference	Reference	Reference	Reference
Direct 80 A - Dual tariff	4850 3060							
Direct 80 A - Dual tariff + MID		4850 3061						
Direct 80 A - Dual tariff + MODBUS communication via RS485			4850 3043					
Direct 80 A - Dual tariff + MODBUS communication via RS485 + MID				4850 3044				
Direct 80 A - Dual tariff + M-Bus communication					4850 3045			
Direct 80 A - Dual tariff + M-Bus communication + MID						4850 3046		
Direct 80 A - Dual tariff + Ethernet Modbus TCP communication							4850 3047	
Direct 80 A - Dual tariff + Ethernet Modbus TCP communication + MID								4850 3048



COUNTIS E2x

Active-energy meters

three-phase - direct 80 A

Single-circuit metering,
measurement &
analysis



COUNTIS E24 - MID

The solution for

- > Industry
- > Infrastructure
- > Data center
- > EV Chargers
- > Shopping centers



Strong points

- > RS485 (MODBUS), M-BUS, Ethernet or pulse outputs
- > Multi-tariff
- > MID certified B+D module
- > Multi-measurement on display
- > Bi-directional metering

MID certification

- > COUNTIS E units comply with the MID directive to guarantee accuracy and reliability when metering, compulsory for energy billing applications.
- > COUNTIS E MID feature tamper-proof components to prevent fraud.



Conformity to standards

- > IEC 62053-21 class 1
- > IEC 62053-23 class 2
- > IEC 62053-31
- > IEC 62052-11
- > EN 50470-1
- > EN 50470-3



Function

The COUNTIS E2x is a modular energy meter displaying the energies (kWh, kVAh and kVA) and other measurements directly on its backlit LCD display. It is designed for three-phase networks and allows a direct connection of up to 80 A.

Advantages

RS485 (MODBUS), M-BUS, Ethernet communication or pulse outputs

To easily centralise your consumption, COUNTIS E2x devices have either one pulse output, one RS485 (MODBUS), M-BUS or an Ethernet Modbus TCP communication output. With RS485 and Ethernet communication models, you can configure your meters remotely.

Multi-tariff

Lets you assign different time slots (every hour, dip times) or different sources (normal, back-up) to your energy readings to monitor your energy consumption in more detail.

MID certified B+D module

COUNTIS E units comply with the MID directive to guarantee accuracy and reliability when metering, compulsory for energy billing applications. "Module B+D" certification guarantees that the design and manufacturing process of products are approved by an accredited laboratory.

Functional diagram

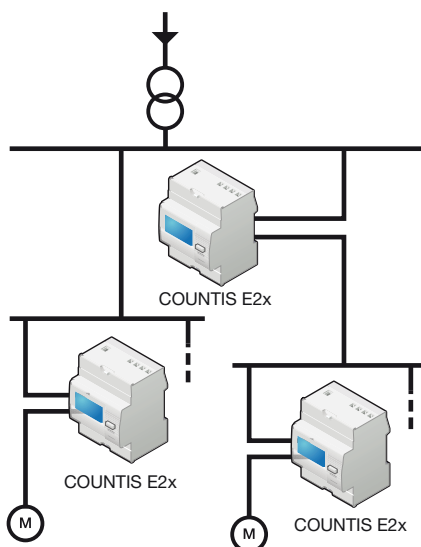

count_224_a_1_x_cat.eps

Common characteristics

- Measurement accuracy: 1%.
- Displayed on backlit screen.
- Multi-measurement available on display.

Models	Model-related specifications
E21	Dual tariff + pulse output
E22	Dual tariff + pulse output + MID
E23	Dual tariff + pulse output + MODBUS RS485 communication
E24	Dual tariff + pulse output + MODBUS RS485 communication + MID
E25	Dual tariff + pulse output + M-BUS communication
E26	Dual tariff+ pulse output + M-BUS communication + MID
E27	Dual tariff + pulse output + Ethernet
E28	Dual tariff + pulse output + Ethernet + MID

Front panel

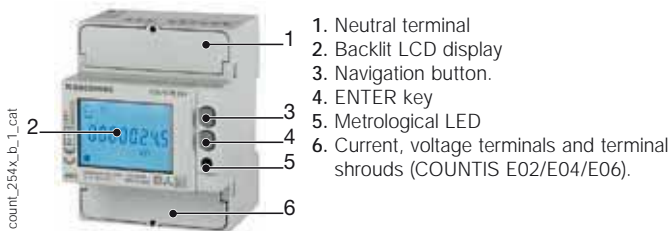

Dimensions (mm)

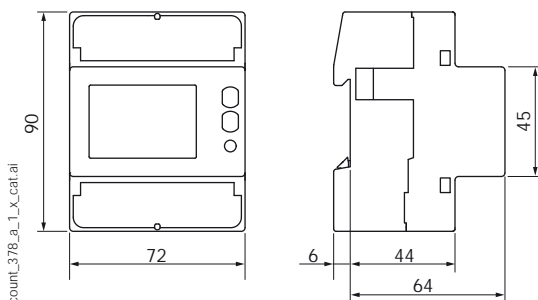

Type	modular
Number of modules	4
Dimensions W x H x D	72 x 90 x 64 mm
Case degree of protection	IP 20
Front degree of protection	IP 51 ⁽¹⁾
Display type	8-digit backlit LCD
Rigid cable cross-section	1.5 ... 35 mm ²
Flexible cable cross-section	1.5 ... 35 mm ²
Weight	440 g

(1) For the installation in a cabinet at least with IP51 protection.

Electrical characteristics

Measurement of currents			
Type	three-phase - direct 80 A		
Input consumption	0.5 VA max. per phase		
Startup current (I _{st})	20 mA		
Minimum current (I _{min})	0.25 A		
Transition current (I _{tr})	0.5 A		
Reference current (I _{ref})	5 A		
Permanent overload (I _{max})	80 A		
Intermittent overload	30 I _{max} over 10 ms		
Voltage measurement			
Range of measurement	230 ... 240 V ±20%		
Consumption (VA)	7.5 VA max (0.5 W) per phase E21/E22/E25/E26 3.5 VA max (1 W) per phase E23/E24/E27/E28		
Permanent overload	290 V phase-neutral / 500 V phase-phase		
Energy accuracy			
Active (according to IEC 62053-21)	Class 1		
Active (according to EN 50470)	Class B		
Reactive (according to IEC 62053-22)	Class 2		
Power supply			
Self-powered	Yes		
Frequency	50/60 Hz		
Output (pulses)			
Optoisolated type (IEC 62053-31)	250 VAC/DC - 100 mA (E21/E22) 27 VDC - 27 mA (E23 ... E28)		
Number	2 (E21/E22) 1 (E23 ... E28)		
Fixed pulse weight	100 Wh		
Pulse duration	50 ± 2 ms ON time 30 ± 2 ms OFF time		
Operating conditions			
Operating temperature	-25 ... 55°C		
Storage temperature	-25 ... 75°C		
Relative humidity	80%		
Communication			
Link	COUNTIS E23/24 RS485	COUNTIS E25/E26 Wired	COUNTIS E27/E28 RJ45
Type	2 half duplex 2 to 3 half duplex (E23/E24)		Full duplex
Protocol	MODBUS RTU	M-BUS	MODBUS TCP, HTTP, NTP, DHCP
Baudrate	1200 ... 115200 bauds	300 ... 9600 bauds	10/100 Mbps

Connection

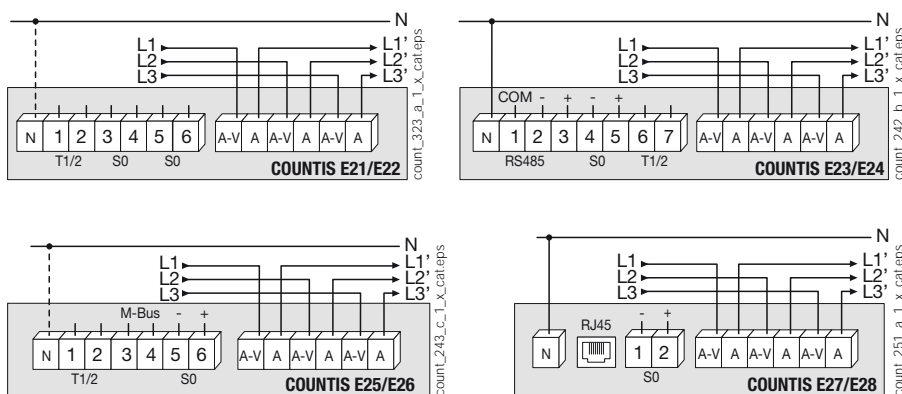

References

Type	COUNTIS E21 Reference 4850 3062	COUNTIS E22 Reference 4850 3049	COUNTIS E23 Reference 4850 3050	COUNTIS E24 Reference 4850 3051	COUNTIS E25 Reference 4850 3052	COUNTIS E26 Reference 4850 3053	COUNTIS E27 Reference 4850 3054	COUNTIS E28 Reference 4850 3055
Direct 80 A - Dual tariff								
Direct 80 A - Dual tariff + MID								
Direct 80 A - Dual tariff + MODBUS communication via RS485								
Direct 80 A - Dual tariff + MODBUS communication via RS485 + MID								
Direct 80 A - Dual tariff + M-Bus communication								
Direct 80 A - Dual tariff + M-Bus communication + MID								
Direct 80 A - Dual tariff + Ethernet Modbus TCP communication								
Direct 80 A - Dual tariff + Ethernet Modbus TCP + MID								



COUNTIS E3x

Active energy meters

three-phase - direct 100 A

Single-circuit metering,
measurement &
analysis



COUNTIS E32 - MID

Function

The COUNTIS E3x is a modular energy meter displaying the energy and power consumed (kWh and kW) directly on its backlit LCD display. It is designed for three-phase load metering and is used for direct connections of up to 100 A.

COUNTIS E32, E34 and E36 are MID certified.

Common characteristics

- Measurement accuracy: 1 %
- Backlit LCD display.
- Detects connection errors.

Advantages

RS485 communication (MODBUS or M-BUS) or pulse output

To enable the remote reporting of energy consumption, COUNTIS E3x are provided with either a pulse output or an RS485 communication output, with MODBUS or M-BUS protocol.

In addition to their reporting functions, COUNTIS E3x with RS485 can be configured remotely and enable access to multi-measurement values.

Detection of connection errors

The product is protected against phase/neutral inversion and detects wiring errors. This simplifies the installation and commissioning, thereby reducing associated costs, and ensures that the device operates correctly.

Principle diagram

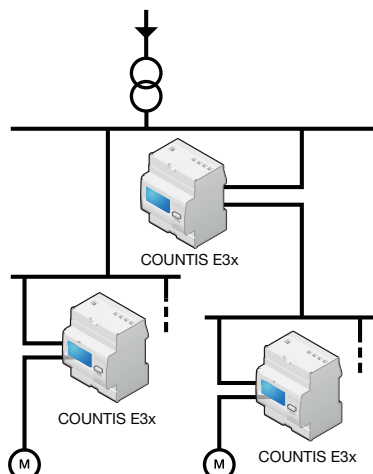

count_225_a_1_x_cat

MID certified B+D module

COUNTIS E products with MID certification provide the guaranteed accuracy required for applications in which sub-billing of the electrical energy consumed is necessary. "Module B+D" certification guarantees that the design and manufacturing process of products are approved by an accredited laboratory.

Bi-directional metering (available only on the E33 and E35)

This function is for metering energy production or energy consumption.

Multi-measurement and load curve

Display of electrical values (I, U, V, P, Q, S, PF) and load curve over a 7 day period via communication.

The solution for

- > Industry
- > Infrastructure
- > Data centre



Strong points

- > RS485 communication (MODBUS or M-BUS) or pulse output
- > Detection of connection errors
- > MID certified B+D module
- > Bi-directional metering
- > Multi-measurement and load curve

MID certification

- > COUNTIS E comply with the MID directive, guaranteeing accuracy and reliability when metering, an indispensable function for energy billing applications.
- > COUNTIS E MID feature tamper-proof components to prevent fraud.



Conformity to standards

- > IEC 62053-21 class 1
- > IEC 62053-31
- > IEC 62053-11
- > EN 50470-1
- > EN 50470-3



Models	Key characteristics
E30	Pulse output
E31	Dual tariff (2 partial counters) + Pulse output
E32	Dual tariff + MID + Pulse output
E33	Dual tariff + RS485 MODBUS communication
E34	Dual tariff + RS485 MODBUS communication + MID
E35	Dual tariff + M-BUS communication
E36	Dual tariff + M-BUS communication + MID

Front panel



1. Terminal shrouds (COUNTIS E32, E34 and E36).
2. Backlit LCD display.
3. MID marking (COUNTIS E32, E34 and E36).
4. Serial number (COUNTIS E32, E34 and E36).
5. Navigation key.
6. Reset key.
7. Metrological LED.

Dimensions (mm)

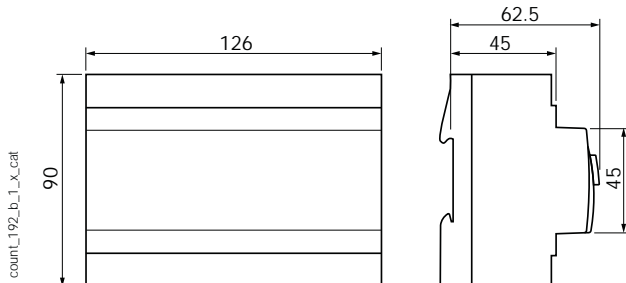

Type	modular
Number of modules	7
Dimensions W x H x D	126 x 90 x 62.5 mm
Case degree of protection	IP20
Front degree of protection	IP51
Display type	backlit LCD display
Rigid cable cross-section	2.5 ... 35 mm ²
Flexible cable cross-section	2.5 ... 35 mm ²
Weight	490 g

Electrical characteristics

Current measurement		
Type	three-phase - direct 100 A	
Input consumption	0.5 VA max. per phase	
Startup current (I_{s3})	80 mA	
Minimum current (I_{min})	0.5 A ⁽¹⁾	
Transition current (I_t)	2 A ⁽²⁾	
Reference current (I_{ref})	20 A ⁽³⁾	
Permanent overload (I_{max})	100 A	
Intermittent overload	3000 A max for 10 ms	
Voltage measurement		
Range of measurement	230 ... 400 V \pm 20 %	
Consumption (VA)	2	
Permanent overload	280 V phase-neutral / 480 V phase-phase	
Energy accuracy		
Active (according to IEC 62053-21)	Class 1	
Active (according to EN 50470)	Class B	
Power supply		
Self-supplied	yes	
Frequency	50 / 60 Hz	
Output (pulsed) (COUNTIS E30/E31/E32)		
Number	1	
Type of optocoupler	IEC 62053-31 class A (20 ... 30 VDC)	
Fixed pulse weight	100 Wh	
Pulse duration	100 ms	
Operating conditions		
Operating temperature	-10 ... 55 °C	
Storage temperature	-20 ... 70 °C	
Relative humidity	85 %	
Communication		
Link	COUNTIS E33/34	COUNTIS E35/E36
Type	RS485	Connection
Protocol	2 half duplex wires	2 half duplex wires
Speed	MODBUS RTU	M-BUS
	4800 ... 38 400 bauds	300 ... 9600 bauds

(1) $I_{min} \leq 0.5 \cdot I_{tr}$

(2) The accuracy class is guaranteed between I_{tr} and I_{max} .

(3) $I_{ref} = I_{b3}$ (base current) = $10 \cdot I_{b1}$ for direct connection COUNTIS.

Connection

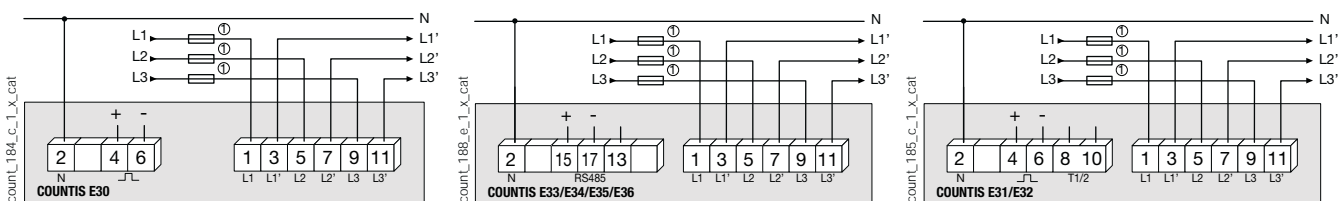

1. 100 A gG / Am fuses max.

References

Type	COUNTIS E30 Reference	COUNTIS E31 Reference	COUNTIS E32 Reference	COUNTIS E33 Reference	COUNTIS E34 Reference	COUNTIS E35 Reference	COUNTIS E36 Reference
100 A direct	4850 3005						
100 A direct - Dual tariff		4850 3006					
100 A direct - Dual tariff + MID			4850 3007				
100 A direct - Dual tariff + MODBUS communication via RS485 ⁽¹⁾				4850 3012			
100 A direct - Dual tariff + MODBUS communication via RS485 + MID ⁽¹⁾					4850 3013		
100 A direct - Dual tariff + M-Bus communication ⁽¹⁾						4850 3025	
100 A direct - Dual tariff + M-Bus communication + MID ⁽¹⁾							4850 3026

(1) 4 tariffs through RS485 communication.



COUNTIS E4x

Active energy meters

three-phase - via CT up to 12000 A

Single-circuit metering,
measurement &
analysis



COUNTIS E44 - MID

Function

The COUNTIS E4x is a modular electrical energy meter displaying the energies (kWh, kVAh and kVArh) and other measurements directly on its backlit LCD display. It is designed for three-phase load metering with connection via CT and is suitable for applications of up to 12000 A.

COUNTIS E42, E44, E46 and E48 are MID certified.

Common characteristics

- Measurement accuracy: 1 % / 0,5%(MID).
- Backlit LCD display.
- Multi-measurement available on display.

Advantages

RS485 (MODBUS), M-BUS, Ethernet communication or pulse outputs

To enable the remote reporting of energy consumption, COUNTIS E4x devices have either one pulse output, one RS485 (MODBUS), M-BUS or an Ethernet Modbus TCP communication output.

In addition to their reporting functions, COUNTIS E4x with RS485 and Ethernet can be configured remotely and enable access to multi-measurement values.

Principle diagram

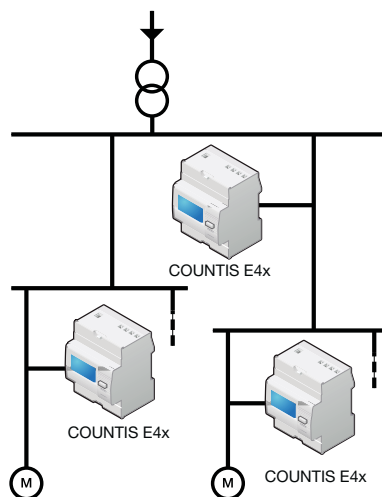

MID certified B+D module

COUNTIS E products with MID certification provide the guaranteed accuracy required for applications in which sub-billing of the electrical energy consumed is necessary. "Module B+D" certification guarantees that the design and manufacturing process of products are approved by an accredited laboratory.

Bi-directional metering

This function is for metering energy production or energy consumption.

Multi-measurement and load curve

Display of electrical values (I, U, V, P, Q, S, PF) and load curve over a 3 day period via communication.

The solution for

- > Industry
- > Infrastructure
- > Data centre
- > EV Chargers



Strong points

- > RS485 (MODBUS), M-BUS, Ethernet or pulse outputs
- > Multi-tariff
- > MID certified B+D module
- > Bi-directional metering
- > Multi-measurement and load curve

MID certification

- > COUNTIS E comply with the MID directive, guaranteeing accuracy and reliability when metering, an indispensable function for energy billing applications.



- > COUNTIS E MID feature tamper-proof components to prevent fraud.

Conformity to standards

- > IEC 62053-21 class 1
- > IEC 62053-23 class 2
- > IEC 62053-31
- > IEC 62053-11
- > EN 50470-1
- > EN 50470-3



Models	Key functions
E41	Dual tariff + Pulse output
E42	Dual tariff + Pulse output + MID
E43	Dual tariff + Pulse output + RS485 MODBUS communication
E44	Dual tariff + Pulse output + RS485 MODBUS communication + MID
E45	Dual tariff + Pulse output + M-BUS communication
E46	Dual tariff + Pulse output + M-BUS communication + MID
E47	Dual tariff + Pulse output + Ethernet
E48	Dual tariff + Pulse output + Ethernet + MID

Front panel

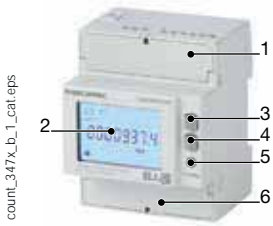

1. Terminal shrouds (COUNTIS E42, E44, E46 and E48).
2. Backlit LCD display.
3. Navigation button.
4. ENTER key.
5. Metrological LED.
6. Current, voltage terminals and terminal shrouds (COUNTIS E42/E44/E46/E48).

Dimensions (mm)

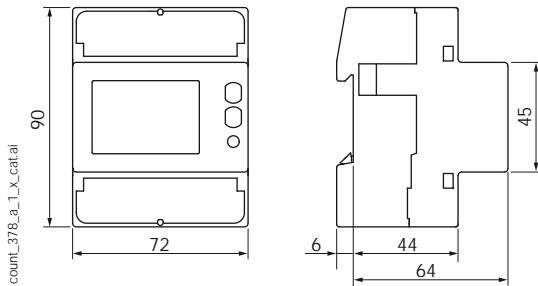

Type	modular
Number of modules	4
Dimensions W x H x D	72 x 90 x 64 mm
Case degree of protection	IP20
Front degree of protection	IP51
Display type	8-digit backlit LCD
Rigid cable cross-section	1.5 ... 6 mm ²
Flexible cable cross-section	1.5 ... 6 mm ²
Weight	322 g

Connection

Recommendation:

- For IT earthing systems, it is recommended that the CT secondary is not connected to earth.
- When disconnecting the COUNTIS, the secondary of each current transformer must be short-circuited. This operation can be carried out automatically by a SOCOMEC PTI, an accessory which is included in this catalogue. Please consult us.

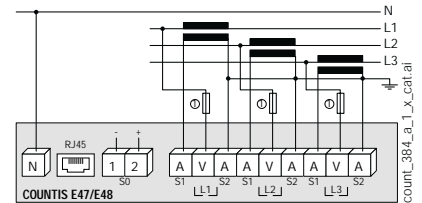
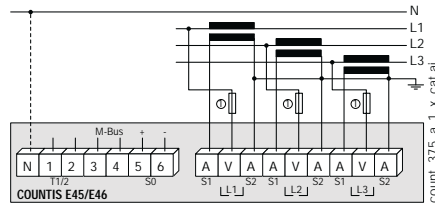
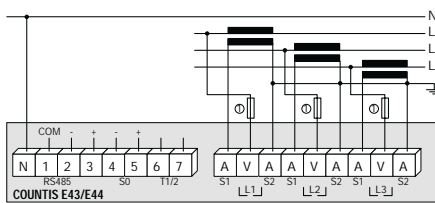
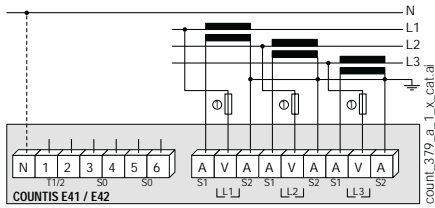

1. Fuses 0.5 A gG / 0.5 A class CC.

References

Type	COUNTIS E41 Reference	COUNTIS E42 Reference	COUNTIS E43 Reference	COUNTIS E44 Reference	COUNTIS E45 Reference	COUNTIS E46 Reference	COUNTIS E47 Reference	COUNTIS E48 Reference
Via CT - Dual tariff	4850 3063							
Via CT - Dual tariff + MID		4850 3064						
Via CT - Dual tariff + MODBUS communication via RS485 ⁽¹⁾			4850 3065					
Via CT - Dual tariff + MODBUS communication via RS485 + MID ⁽¹⁾				4850 3066				
Via CT - Dual tariff + M-Bus communication ⁽¹⁾					4850 3067			
Via CT - Dual tariff + M-Bus communication + MID ⁽¹⁾						4850 3068		
Via CT - Dual tariff + Ethernet Modbus TCP communication ⁽¹⁾							4850 3056	
Via CT - Dual tariff + Ethernet Modbus TCP communication + MID ⁽¹⁾								4850 3057

(1) 4 tariffs through RS485 communication.

Electrical characteristics

Current measurement

Type	three-phase on CT1 and 5A up to 12000 A
Input consumption	0.5 VA max. per phase
Startup current (I _{st})	1 mA - Class C
	2 mA - Class 1
Minimum current (I _{min})	10 mA
Transition current (I _{tr})	50 mA
Reference current (I _{ref})	1 A
Permanent overload (I _{max})	6 A
Intermittent overload	120 A for 0.5 s

Voltage measurement

Range of measurement	230 ... 240 V ± 20 %
Consumption (VA)	7.5 VA max (0.5 W) per phase E41/E42/E45/E46 3.5 VA max (1 W) per phase E43/E44/E47/E48
Permanent overload	290 V phase-neutral / 500 V phase-phase

Energy accuracy

Active (according to IEC 62053-21)	Class 1
Active (according to EN 50470)	Class C
Reactive (according to IEC 62053-22)	Class 2

Power supply

Self-supplied	yes
Frequency	50 / 60 Hz

Output (pulse)

Number	2 (E41/E42) 1 (E43 ... E48)
Type of optoisolated	250 VAC/DC - 100 mA (E41/E42) 27 VDC - 27 mA (E43 ... E48)
Pulse weight	1 Wh ⇒ CT = 1 ... 4 5 Wh ⇒ CT = 5 ... 24 25 Wh ⇒ CT = 25 ... 124 125 Wh ⇒ CT = 125 ... 624 1000 Wh ⇒ CT = 625 ... 3124 10000 Wh ⇒ CT = 3125 ... 12000
Pulse duration	50 ± 2 ms ON time 30 ± 2 ms OFF time

Operating conditions

Operating temperature	-25 ... +55 °C
Storage temperature	-25 ... +75 °C
Relative humidity	80 %

Communication	COUNTIS E43/E44	COUNTIS E45/E46	COUNTIS E47/E48
Link	RS485	Wired	RJ45
Type	2 to 3 half duplex	2 half duplex	Full duplex
Protocol	MODBUS RTU	M-BUS	MODBUS TCP, STTP, NTP, DHCP
Speed	1200 ... 115200 bauds	300 ... 9600 bauds	10/100 Mbps



COUNTIS E5x

Active energy meters

three-phase - via CT up to 6000 A

Single-circuit metering,
measurement &
analysis



count_196_b_1_cat

COUNTIS E53 up to 6000 A via CT

The solution for

- > Industry
- > Infrastructure
- > Data centres



Strong points

- > RS485 MODBUS communication or pulse output
- > Large backlit LCD display
- > Detection of connection errors
- > Direct display of multi-measurement and metering values

Conformity to standards

- > IEC 62053-23 class 2
- > IEC 62053-22 class 0.5S
- > IEC 61557-12



Management software

- > To get the most effective use from your Socomec measurement and metering devices, we offer a range of dedicated software tools.

Function

The COUNTIS E5x is a panel mounted active and reactive electrical energy meter displaying energy and multi-measurement values directly on its large backlit LCD display. It is designed for utilisation on three-phase or single-phase networks with connection via CT and is suitable for applications of up to 6000 A. The CT ratio can be configured by the user via the keypad and the display, or via RS485 MODBUS communication (E53).

Common characteristics

- Measurement accuracy: 0.5%.
- Large backlit LCD display.
- Direct access to multi-measurement and metering values.
- Detects connection errors.

Advantages

RS485 MODBUS communication or pulse output

To enable the remote reporting of energy consumption, COUNTIS E5x are provided with either a pulse output (E50) or an RS485 MODBUS communication output (E53). Remote configuration of the Countis E53 is possible via RS485 MODBUS communication.

Detection of connection errors

The COUNTIS E5x is protected against phase/neutral inversion and has an integrated test function which can be utilised to detect wiring errors. This function enables CT installation errors to be corrected without having to remake connections. This simplifies the installation and commissioning, thereby reducing associated costs, and ensures that the device operates correctly.

Large backlit LCD display

Thanks to its large backlit LCD display and its multiple viewing screens with direct pushbutton access, COUNTIS E5x provide clear readings and are easy to use.

Principle diagram

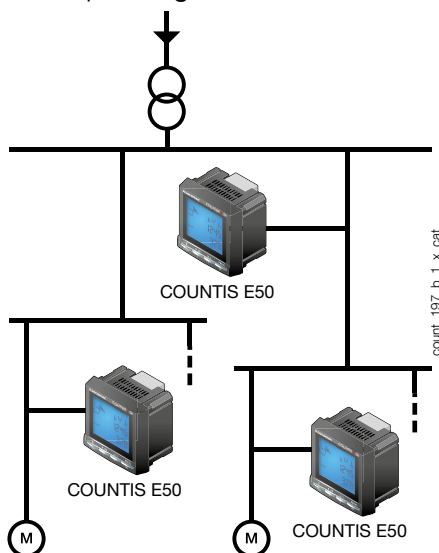

count_197_b_1_x_cat

They directly display a number of total/partial metering and multi-measurement values : \pm kWh, \pm kvarh, kVAh, I, U, V, S, PF, etc.

Direct display of multi-measurement and metering values

Multi-measurement

- Currents: instantaneous: I1, I2, I3
- Voltages: instantaneous: V1, V2, V3, U12, U23, U31
- Power:
 - instantaneous: 3P, 3Q, 3S
 - maximum average: 3P
- Power factor:
 - instantaneous: 3PF

Metering

- Active energy: \pm kWh
- Reactive energy: \pm kvarh
- Apparent energy: kVAh

models	Key characteristics
E50	Pulse output
E53	RS485 MODBUS communication

Front panel



1. Backlit LCD display
2. Energy display and test function key
3. Power and power factor display key
4. Current and voltage display key
5. Programming mode access key

Dimensions (mm)

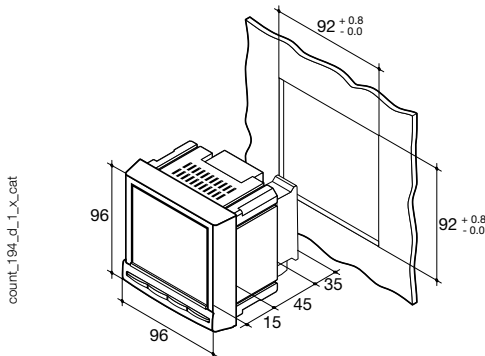

Type	Panel mounting
Dimensions W x H x D	96 x 96 x 60 mm
Case degree of protection	IP30
Front degree of protection	IP52
Display type	backlit LCD display
Voltage and current connection cross-section	0.5 ... 2.5 mm ²
Current connection cross-section	1.5 ... 6 mm ²
Weight	370 g

(1) $I_{min} \leq 0.5 \cdot I_r$

(2) The accuracy class is guaranteed between I_r and I_{max} .

(3) $I_{ref} = I_{(n)}$ (base current) = $10 \cdot I_{(n)}$ for direct connection COUNTIS.

Electrical characteristics

Current measurement

Type	three-phase on CT/5A up to 6000 A
Input consumption	< 0.6 VA
Startup current (I_{st})	40 mA
Minimum current (I_{min})	50 mA ⁽¹⁾
Transition current (I_r)	250 mA ⁽²⁾
Reference current (I_{ref})	5 A ⁽³⁾
Permanent overload (I_{max})	6 A
Intermittent overload	50 A for 1 s

Voltage measurement

Range of measurement	86 ... 520 VAC
Input consumption	< 0.1 VA
Permanent overload	800 VAC

Energy accuracy

Reactive (according to IEC 62053-23)	Class 2
Active (according to IEC 62053-22)	Class 0.5S

Power supply

Self-supplied	no
Auxiliary power supply U_s	110 ... 400 VAC / 125... 350 VDC ± 10 %
Frequency	45 ... 65 Hz

Output (pulsed)

Number	1
Type	100 VDC - 0.5 A - 10 VA
Max. number of operations	$\leq 10^8$

Operating conditions

Operating temperature	-10 ... 55 °C
Storage temperature	-20 ... 85 °C
Relative humidity	95 %

Communication

Link	RS485
Type	2 ... 3 half duplex wires
Protocol	MODBUS RTU
MODBUS [®] speed	1400 ... 38400 bauds

References

Type	COUNTIS E50 Reference	COUNTIS E53 Reference
Pulse output	4850 3010	
RS485 MODBUS communication ⁽¹⁾		4850 3011
Management software for COUNTIS		

(1) 4 tariffs through RS485 communication.

Connection

Recommendation:

- For IT earthing systems, it is recommended that the CT secondary is not connected to earth.

- When disconnecting the COUNTIS, the secondary of each current transformer must be short-circuited. This operation can be carried out automatically by a SOCOMEC PTI, an accessory which is included in this catalogue. Please consult us.

Low voltage balanced network 3/4 wires with 1 CT

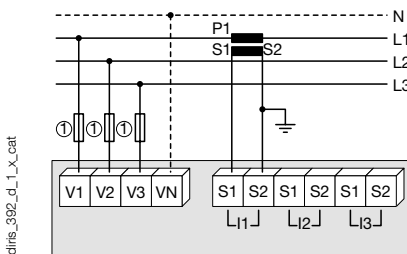

Use of 1 CT reduces by 0.5% the accuracy of the phases, the current of which is worked out by vector calculation.

Low voltage unbalanced network 3/4 wires with 3 CTs

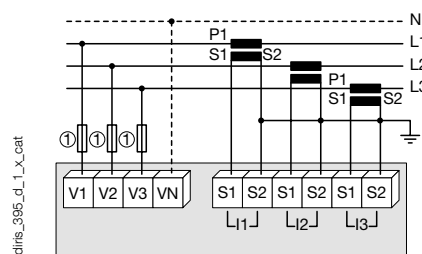

3 wires with 2 CTs

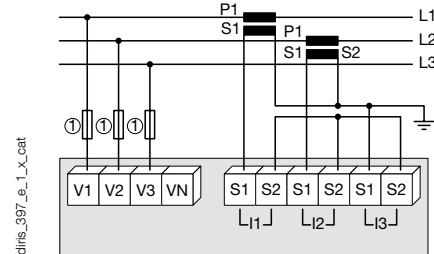

Use of 2 CT reduces by 0.5% the accuracy of the phases, the current of which is worked out by vector calculation.

Additional information

Communication via RS485 link

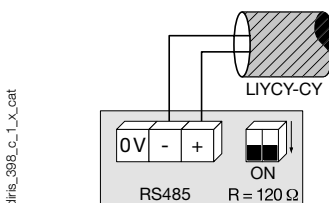

AC & DC auxiliary power supply

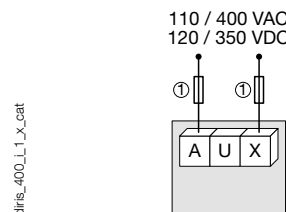

1. Fuses 0.5 A gG / 0.5 A class CC.



COUNTIS ECi3

Multi-utility pulse concentrator

Single-circuit metering,
measurement &
analysis



COUNTIS ECi3

The solution for

- > Data centres
- > Industry
- > Infrastructure



Strong points

- > Up to 7 multi-utility meters and 2 analogue sensors
- > Load curves
- > RS485 MODBUS communication
- > Improved customisation

Management software

- > To get the most effective use from your Socomec measurement and metering devices, we offer a range of dedicated software tools.

Function

The COUNTIS ECi3 is a multi-utility pulse concentrator which communicates via an RS485 link using MODBUS protocol.

It enables pulses from water, gas, compressed air, electricity meters and, for the COUNTIS ECi3, the output of analogue sensors (light, temperature, wind etc.) to be registered and stored. All data, ie. total and partial meters and load curves (available for all logical and analogue inputs) can be centralised via RS485 communication using MODBUS protocol.

Principle diagram

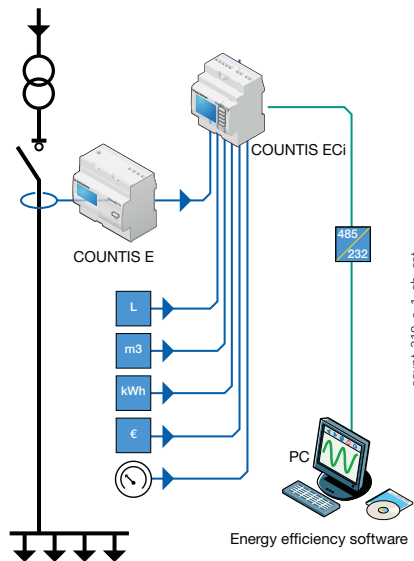

Advantages

Up to 7 multi-utility meters and 2 analogue sensors

- 7 digital inputs + 2 analogue inputs.
- Total, partial and programmable metering (day, week, month, year).

Load curves

Load curves are available for each of the 7 logical inputs.

A history of average values are available for the 2 analogue inputs (ECi3).

RS485 MODBUS communication

- Centralisation and transmission of pulse and analogue data to a supervision station.
- Remote configuration of COUNTIS ECi3 device.

Improved customisation

- Selection of the measuring unit: kWh, m³, liters.
 - Selection of the currency unit: €, K€, £, \$.
- Values can be displayed in the unit of your choice and energy costs can be directly calculated.

Models	Key characteristics
ECi2	7 insulated inputs
ECi3	7 insulated inputs + 2 analogue inputs.

Front panel

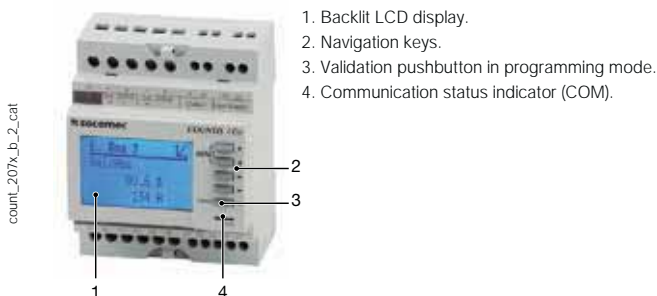

Dimensions (mm)

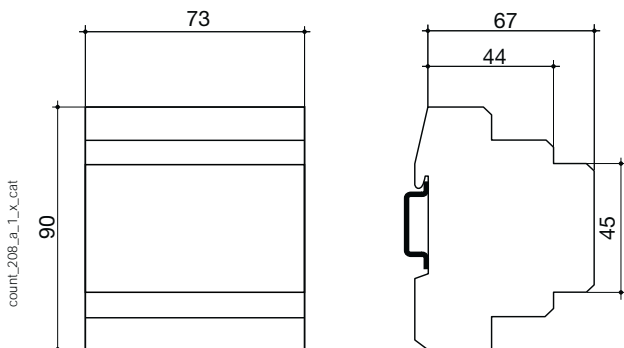

Type	modular
Number of modules	4
Dimensions W x H x D	73 x 90 x 67 mm
Case degree of protection	IP20
Front degree of protection	IP51
Display type	backlit LCD display
Terminal blocks type	fixed
Rigid cable cross-section	1 ... 10 mm ²
Flexible cable cross-section	0.5 ... 6 mm ²
Weight	215 g

Characteristics

Auxiliary power supply	
Self-supplied	no
Alternating voltage	110 / 400 VAC
Direct voltage	120 / 300 VDC
Tolerance	± 10 %
Frequency	45 / 65 Hz
Consumption	5 VA
Insulation voltage	3.5 kV
Communication	
Link	RS485
Type	2 ... 3 half duplex wires
Protocol	MODBUS RTU
MODBUS® speed	9600 ... 38400 bauds
Inputs	
Number	7
Control voltage (integrated)	10 ... 30 VDC
Minimum signal width	10 ms
Maximum signal width	2 s
Minimum duration between 2 pulses	30 ms
Edge triggering	rising
Analogue inputs (ECi3)	
Number	2
Current	25 mA
Accuracy	0.5 %
Response time	500 ms
Input resistance	200 Ω
Consumption	0.1 VA
Operating conditions	
Operating temperature	-10 ... +55 °C
Storage temperature	-20 ... +70 °C
Relative humidity	95 %

Connection

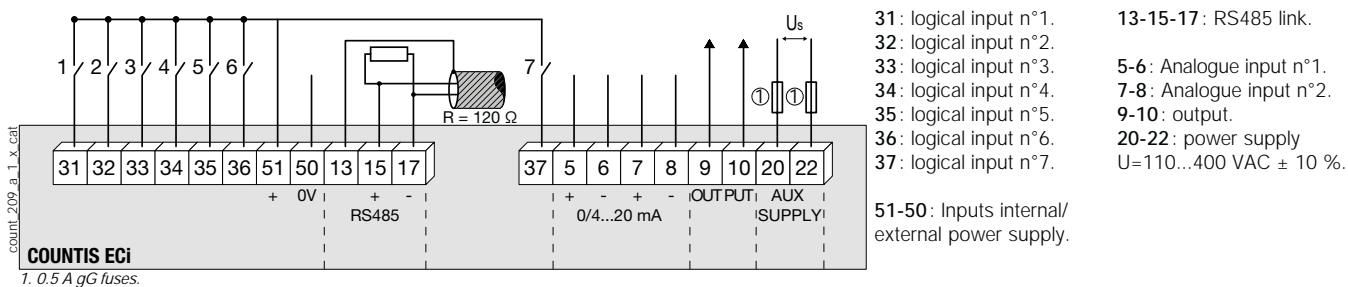

References

Auxiliary power supply U_s	COUNTIS ECi2 Reference 4853 0000	COUNTIS ECi3 Reference 4853 0001
230 / 400 VAC		
230 / 400 VAC + 2 analogue inputs		4853 0001
Description of accessories	Reference 192J 8015	Reference 192J 8015
Panel mounting kit		



Current transformers

Measurement devices

from 5 to 5000 A

Current transformers



Three-phase CT



Bar-through CT

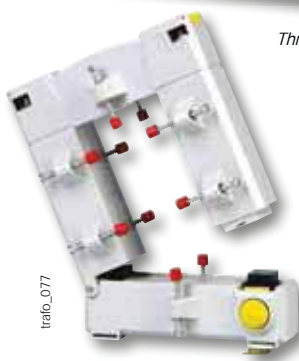

Split-core transformer



Cable-through CT

The solution for

- > Industry
- > Office buildings



Strong points

- > An adapted accuracy class
- > A wide range of ratings and dimensions
- > Quick and easy to mount

Conformity to standards

- > IEC 61869-2
- > IEC 61439-1



Available on request

SOCOMEK also offer customised solutions:

- > 1 A secondary
- > Double or triple primary ratio
- > Voltage transformer
- > Summation CTs

Function

SOCOMEK current transformers deliver to the secondary a standard current proportional to the primary current and adapted to the rating of the associated device. They are equipped as standard with removable terminal covers and double terminals allowing the secondary to be short-circuited without any risk.

They are mounted using two screw-on metal brackets or, in certain cases, by a clip-on DIN-rail fastener. The connections are made by screws or by fast-on terminals.

- Accuracy class: 0.2s — 0.5 or 1.
- Dielectric quality: 3 kV — 50 Hz — 1 min.
- Operating frequency: 50 — 60 Hz.
- Permanent overload: 1.2 In.
- Insulation class: E (120 °C).

Advantages

An adapted accuracy class

In order to get the best of your DIRIS multifunction meters and COUNTIS energy meters, we can provide current transformers with the following accuracy classes: 0.2s; 0.5; 1 or 3.

A wide range of ratings and dimensions

Your measurement process can be optimised whatever your needs in terms of ratings, space requirements, conductor sizing or accuracy class. A wide range of combinations are available in our standard range with specific versions available on request (other ratios, tropicalisation and specific frequency, class or burden).

Quick and easy to mount

Our current transformers are adapted to any type of mounting: edgewise or flat mounting, DIN-rail or back-plate mounting. Implementation is easy and rapid.

Composition of the range

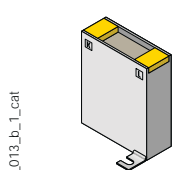

Primary wound moulded case CT

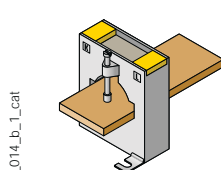

Bar or cable-through CT

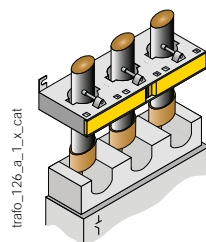

Bar or cable-through three-phase CT

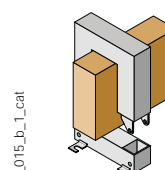

Bar-through split-core CT

Primary wound moulded case CT

References

Primary	Secondary ⁽¹⁾	TRB 60		TRB 70		T2RB 115		TRB 135	
		Class 0.5	Reference	Class 0.5	Reference	Class 0.2s	Reference	Class 0.5	Reference
5 A	5 A	2.5 VA	192T 0505	10 VA	192T 0521				
10 A	5 A	2.5 VA	192T 0510	10 VA	192T 0522				
15 A	5 A	2.5 VA	192T 0515	10 VA	192T 0523				
20 A	5 A	2.5 VA	192T 0520	10 VA	192T 0524				
25 A	5 A			10 VA	192T 0525	7.5 VA	192U 0402	10 VA	192T 0603
30 A	5 A			5 VA	192T 0530	7.5 VA	192U 0403	10 VA	192T 0607
40 A	5 A			5 VA	192T 0541	7.5 VA	192U 0404	10 VA	192T 0604
50 A	5 A			5 VA	192T 0551	7.5 VA	192U 0405	10 VA	192T 0605
60 A	5 A					7.5 VA	192U 0406	10 VA	192T 0606
75 A	5 A					7.5 VA	192U 0407	10 VA	192T 0608
80 A	5 A					7.5 VA	192U 0408	10 VA	192T 0609
100 A	5 A							10 VA	192T 0610
125 A	5 A					7.5 VA	192U 0412	10 VA	192T 0612
150 A	5 A					7.5 VA	192U 0415	10 VA	192T 0615

(1) Secondary 1 A: on request.

Accessories

Description of accessories	TRB 60 Reference	TRB 70 Reference		TRB 135 Reference
DIN-rail mounting	192T 0003	192T 0005 ⁽¹⁾		
Sealable cover	192T 0105	192T 0103		192T 0101 ⁽²⁾

(1) Not available for 50 A rating

(2) For 125 and 150 A ratings, use reference 192T 0103.

CT Plug-in transducer (CEA-VA)

Power supply	Output	TRB 60 Reference	TRB 70 Reference
Self-supplied	0-20 mA / 0-10 VDC	192Y 0015	192Y 0025 ⁽¹⁾
230 VAC	0-20 mA / 0-10 VDC	192Y 0215	192Y 0225 ⁽¹⁾
24 VDC	0-20 mA / 0-10 VDC	192Y 0115	192Y 0125 ⁽¹⁾

(1) Not available for ratings 40 and 50 A

CT Plug-in transducer (CEA-VA4)

Power supply	Output	TRB 60 Reference	TRB 70 Reference
230 VAC	4-20 mA / 0-10 VDC	192T 0255	192Y 0265 ⁽¹⁾
24 VDC	4-20 mA / 0-10 VDC	192Y 0155	192Y 0165 ⁽¹⁾

(1) Not available for ratings 40 and 50 A

Certificate of performance

Each class 0.2s current transformer is supplied with an individual certificate of performance, attesting to its accuracy.

Current transformers

Measurement devices
from 5 to 5000 A

Primary wound moulded case CT (continued)

Dimensions (mm)

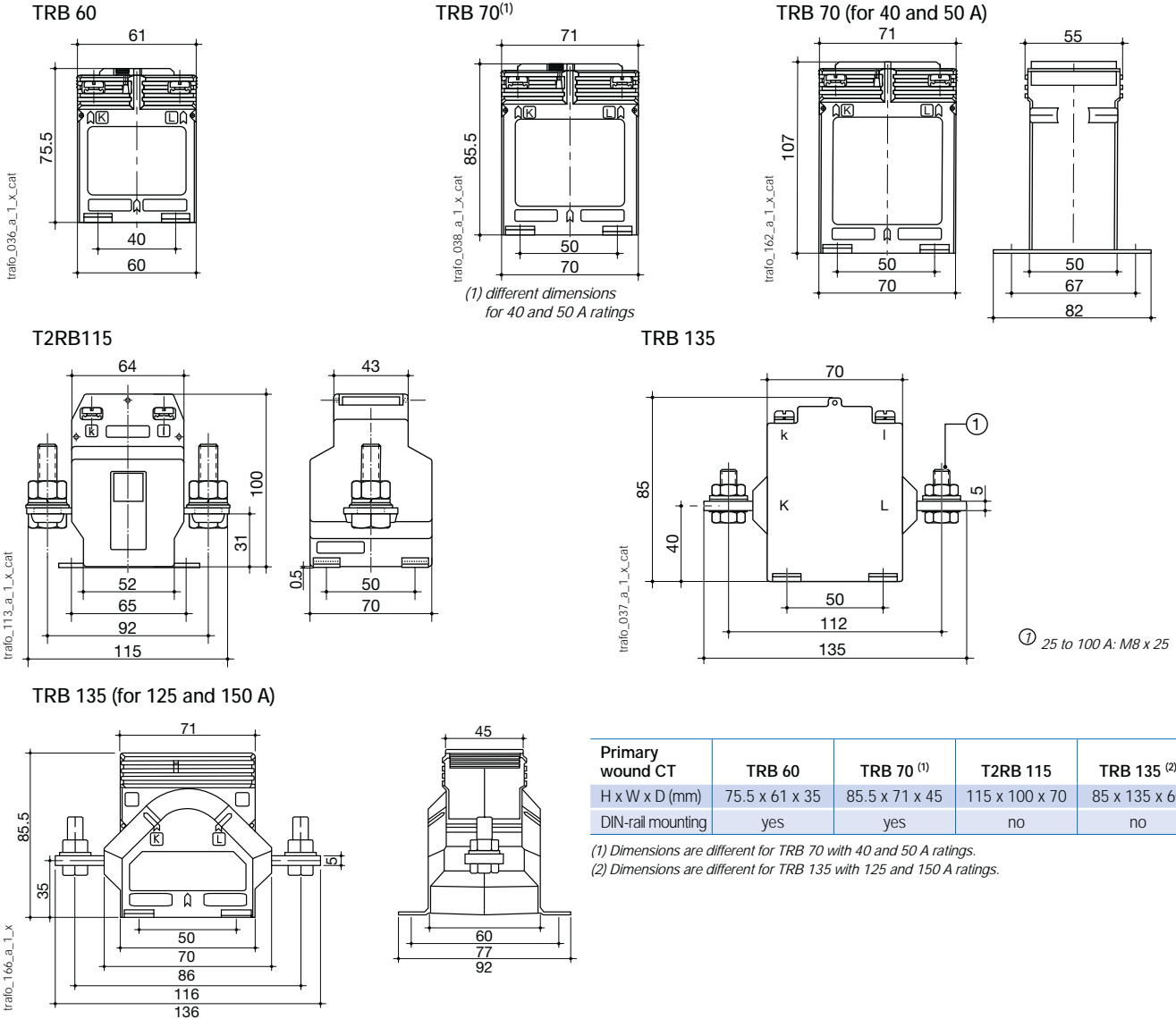

Primary wound CT	TRB 60	TRB 70 ⁽¹⁾	T2RB 115	TRB 135 ⁽²⁾
H x W x D (mm)	75.5 x 61 x 35	85.5 x 71 x 45	115 x 100 x 70	85 x 135 x 60
DIN-rail mounting	yes	yes	no	no

(1) Dimensions are different for TRB 70 with 40 and 50 A ratings.
(2) Dimensions are different for TRB 135 with 125 and 150 A ratings.

Associated transducers



Transducer to be associated with adapted current transformers:

- Class 0.5.
- Input: 1 or 5 A.
- Output:
 - 0-20 mA, 0-10 V (type CEA-VA)
 - 4-20 mA, 0-10 V (type CEA-VA4)
- Self-supplied or auxiliary power supply 24 VDC or 230 VAC.
- 3 sizes according to the CT: type 1, 2 or 3.

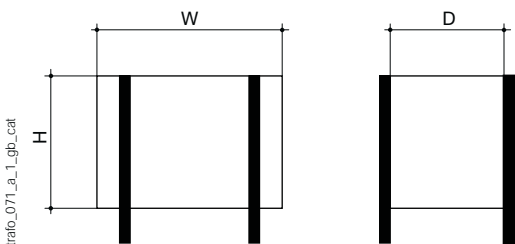
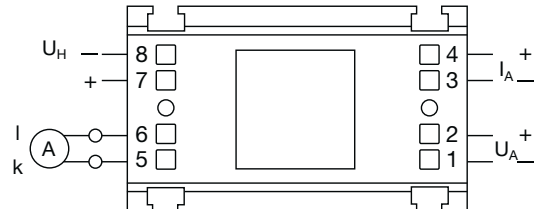

Dimensions (mm)

Converter	For CT	Height (mm)	Width (mm)	Depth (mm)
Type 1	TRB 60	50.5	60	32.5
Type 2	TRB 70	50	70	43

Cable-through CT

References

Primary	Secondary ⁽¹⁾	TCA 14		TCA 21		TCA 22		T2CA 225		
		Class 1	Reference	Class 1	Class 0.5	Reference	Class 1	Reference	Class 0.2s	Reference
40 A	5 A	1	192T 1404							
50 A	5 A	1	192T 1405							
60 A	5 A	1.5	192T 1406	1 VA		192T 2006				
75 A	5 A	1.5	192T 1407	1.5 VA		192T 2007				
80 A	5 A			1.5 VA		192T 2008				
100 A	5 A	2.5	192T 1410		1.5 VA	192T 2010	1 VA	192T 2022		
125 A	5 A	2.5	192T 1412		1.5 VA	192T 2012				
150 A	5 A	2.5	192T 1415		1.5 VA	192T 2015	1.5 VA	192T 2023	1.5 VA	192U 2215
200 A	5 A				2.5 VA	192T 2020	2.5 VA	192T 2024	2.5 VA	192U 2220
250 A	5 A				2.5 VA	192T 2016	3.75 VA	192T 2025	5 VA	192U 2225
300 A	5 A				2.5 VA	192T 2017	3.75 VA	192T 2030	5 VA	192U 2230
400 A	5 A						5 VA	192T 2034	5 VA	192U 2240
500 A	5 A						5 VA	192T 2035 (2)	10 VA	192U 2250
600 A	5 A						5 VA	192T 2036 (2)	10 VA	192U 2260

(1) Secondary 1 A: on request.

(2) Dimensions of T2CA 225

Accessories

Description of accessories	TCA 14 Reference	TCA 21 Reference	TCA 22 Reference	T2CA 225 Reference
DIN-rail mounting	192T 0006	192T 0006	192T 0007	192T 0003
Guide tube Ø 8.5 mm ⁽¹⁾		192T 0020		
Guide tube Ø 12.5 mm ⁽¹⁾		192T 0021	192T 0023	
Guide tube Ø 16.5 mm ⁽¹⁾			192T 0024	
Sealable cover				192T 0105

(1) For centralising cables within the CT aperture.

Dimensions (mm)

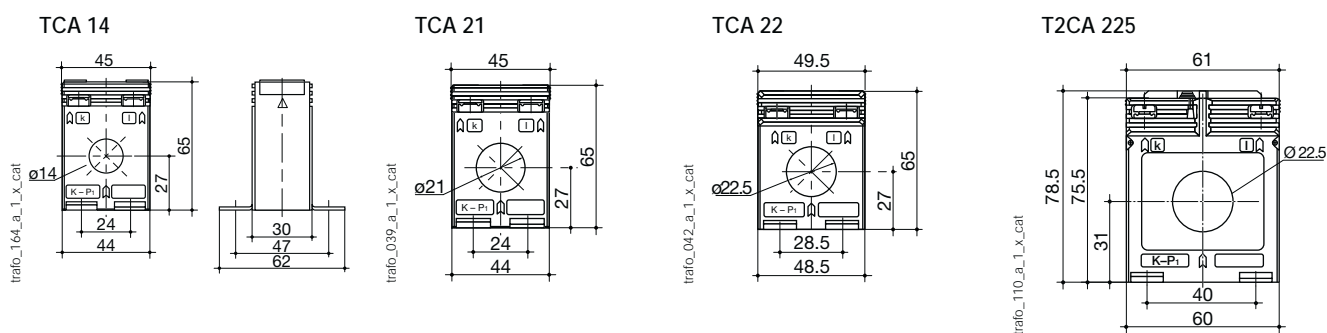

Cable-through CT	TCA 14	TCA 21	TCA 22 ⁽¹⁾	T2CA 225
Ø cable (mm)	14	21	22.5	22.5
H x W x D (mm)	65 x 45 x 30	65 x 45 x 30	65 x 49.5 x 35	78.5 x 61 x 35
DIN-rail mounting	yes	yes	yes	yes

(1) Dimensions are different for 600 A: 78.5x61x35.

Current transformers

Measurement devices

from 5 to 5000 A

Bar or cable-through CT

References

Primary	Secondary ⁽¹⁾	TCB 17-20		TCB 26-30			T2CB 26-30		TCB 28-30		
		Class 1	Reference	Class 0.5	Class 1	Reference	Class 0.2s	Reference	Class 0.5	Class 1	Reference
50 A	5 A				1 VA	192T 2305					
60 A	5 A	1 VA	192T 2106		1 VA	192T 2306					
75 A	5 A	1 VA	192T 2107		1.5 VA	192T 2307					
80 A	5 A	1.25 VA	192T 2108		1.5 VA	192T 2308				1.25 VA	192T 2408
100 A	5 A	1.5 VA	192T 2110	1.5 VA		192T 2310				1.5 VA	192T 2410
125 A	5 A	1.5 VA	192T 2112	1.5 VA		192T 2312				2.5 VA	192T 2412
150 A	5 A	2.5 VA	192T 2115	1.5 VA		192T 2315	1.5 VA	192U 2315		2.5 VA	192T 2415
160 A	5 A	2.5 VA	192T 2116								
200 A	5 A	2.5 VA	192T 2120	2.5 VA		192T 2320	2.5 VA	192U 2320	2.5 VA		192T 2420
250 A	5 A	5 VA	192T 2125	5 VA		192T 2325	2.5 VA	192U 2325	2.5 VA		192T 2425
300 A	5 A	5 VA	192T 2130	5 VA		192T 2330	5 VA	192U 2330	2.5 VA		192T 2430
400 A	5 A	5 VA	192T 2140	5 VA		192T 2340	5 VA	192U 2340	5 VA		192T 2440
500 A	5 A			5 VA		192T 2350	5 VA	192U 2350	5 VA		192T 2450
600 A	5 A			5 VA		192T 2360	5 VA	192U 2360			
750 A	5 A			5 VA		192T 2375	5 VA	192U 2375			

(1) Secondary 1 A: on request.

Primary	Secondary ⁽¹⁾	TCB 26-40		TCB 32-40			T2CB 32-40	
		Class 1	Reference	Class 0.5	Class 1	Reference	Class 0.2s	Reference
75 A	5 A				1.5 VA	192T 4007		
100 A	5 A	1.5 VA	192T 3210	1.5 VA		192T 4010		
125 A	5 A	2.5 VA	192T 3212	1.5 VA		192T 4012		
150 A	5 A	2.5 VA	192T 3215	2.5 VA		192T 4015		
160 A	5 A	2.5 VA	192T 3216					
200 A	5 A	2.5 VA	192T 3220	5 VA		192T 4020	2.5 VA	192U 4020
250 A	5 A	2.5 VA	192T 3225	5 VA		192T 4025	5 VA	192U 4025
300 A	5 A	5 VA	192T 3230	10 VA		192T 4030	5 VA	192U 4030
400 A	5 A	5 VA	192T 3240	10 VA		192T 4040	5 VA	192U 4040
500 A	5 A	5 VA	192T 3250	10 VA		192T 4050	5 VA	192U 4050
600 A	5 A	5 VA	192T 3260	10 VA		192T 4060	5 VA	192U 4060
750 A	5 A	10 VA	192T 3275	10 VA		192T 4075	5 VA	192U 4075
800 A	5 A			10 VA		192T 4080		
1000 A	5 A			10 VA		192T 4090		

(1) Secondary 1 A: on request.

Accessories

Description of accessories	TCB 17-20 Reference	TCB 26-30 Reference	TCB 26-40 Reference	TCB 32-40 Reference
DIN-rail mounting	192T 0007	192T 0003	192T 0003	192T 0005
Sealable cover		192T 0105	192T 0105	192T 0103

CT Plug-in transducer (CEA-VA)

Power supply	Output	TCB 26-30 Reference	TCB 26-40 Reference	TCB 32-40 Reference
Self-supplied	0-20 mA / 0-10 VDC	192Y 0015	192Y 0015	192Y 0035
230 VAC	0-20 mA / 0-10 VDC	192Y 0215	192Y 0215	192Y 0235
24 VDC	0-20 mA / 0-10 VDC	192Y 0115	192Y 0115	192Y 0135

CT Plug-in transducer (CEA-VA4)

Power supply	Output	TCB 26-30 Reference	TCB 26-40 Reference	TCB 32-40 Reference
230 VAC	4-20 mA / 0-10 VDC	192T 0255	192T 0255	192Y 0275
24 VDC	4-20 mA / 0-10 VDC	192Y 0155	192Y 0155	192Y 0175

References

Primary	Secondary ⁽¹⁾	TCB 44-50		TCB 44-63		T2CB 44-63	
		Class 0.5	Reference	Class 0.5	Reference	Class 0.2s	Reference
150 A	5 A	1.5 VA	192T 5015				
200 A	5 A	2.5 VA	192T 5020	1.5 VA	192T 6420		
250 A	5 A	5 VA	192T 5025	1.5 VA	192T 6425		
300 A	5 A	5 VA	192T 5030	2.5 VA	192T 6430	5 VA	192U 6430
400 A	5 A	10 VA	192T 5040	5 VA	192T 6440	5 VA	192U 6440
500 A	5 A	10 VA	192T 5050	10 VA	192T 6450	10 VA	192U 6450
600 A	5 A	10 VA	192T 5060	10 VA	192T 6460	10 VA	192U 6460
750 A	5 A	10 VA	192T 5075	10 VA	192T 6475	10 VA	192U 6475
800 A	5 A	15 VA	192T 5080	10 VA	192T 6480		
1000 A	5 A	15 VA	192T 5090	15 VA	192T 6490	10 VA	192U 6490
1200 A	5 A	15 VA	192T 5092	15 VA	192T 6492	10 VA	192U 6492
1250 A	5 A	15 VA	192T 5095	15 VA	192T 6493	10 VA	192U 6493
1500 A	5 A			15 VA	192T 6495	10 VA	192U 6495
1600 A	5 A			15 VA	192T 6494		

(1) Secondary 1 A: on request.

Primary	Secondary ⁽¹⁾	TCB 55-80		TCB 85-100		TCB 100-125	
		Class 0.5	Reference	Class 0.5	Reference	Class 0.5	Reference
400 A	5 A	2.5 VA	192T 8140				
500 A	5 A	5 VA	192T 8150				
600 A	5 A	5 VA	192T 8160				
750 A	5 A	10 VA	192T 8175	2.5 VA	192T 9675		
800 A	5 A	10 VA	192T 8180	5 VA	192T 9680		
1000 A	5 A	15 VA	192T 8190	10 VA	192T 9690	5 VA	192T 9590
1200 A	5 A	15 VA	192T 8192	10 VA	192T 9692	10 VA	192T 9592
1250 A	5 A	15 VA	192T 8193	15 VA	192T 9693	10 VA	192T 9593
1500 A	5 A	15 VA	192T 8195	15 VA	192T 9695	15 VA	192T 9595
1600 A	5 A	15 VA	192T 8194	15 VA	192T 9694		
2000 A	5 A	15 VA	192T 8196	30 VA	192T 9696	30 VA	192T 9596
2500 A	5 A			30 VA	192T 9697	30 VA	192T 9597
3000 A	5 A			30 VA	192T 9698	30 VA	192T 9598

(1) Secondary 1 A: on request.

Accessories

Description of accessories	TCB 44-50 Reference	TCB 44-63 Reference	TCB 55-80 Reference	TCB 85-100 Reference	TCB 100-125 Reference
Sealable cover	192T 0102	192T 0102	192T 0102	192T 0106	192T 0106

CT Plug-in transducer (CEA-VA)

Power supply	Output	TCB 44-50 Reference	TCB 44-63 Reference	TCB 55-80 Reference
Self-supplied	0-20 mA / 0-10 VDC		192Y 0045	192Y 0045
230 VAC	0-20 mA / 0-10 VDC		192Y 0245	192Y 0245
24 VDC	0-20 mA / 0-10 VDC		192Y 0145	192Y 0145

CT Plug-in transducer (CEA-VA4)

Input	Output	TCB 44-50 Reference	TCB 44-63 Reference	TCB 55-80 Reference
230 VAC	4-20 mA / 0-10 VDC		192Y 0285	192Y 0285
24 VDC	4-20 mA / 0-10 VDC		192Y 0185	192Y 0185

Current transformers

Measurement devices

from 5 to 5000 A

Bar or cable-through CT (continued)

Dimensions (mm)

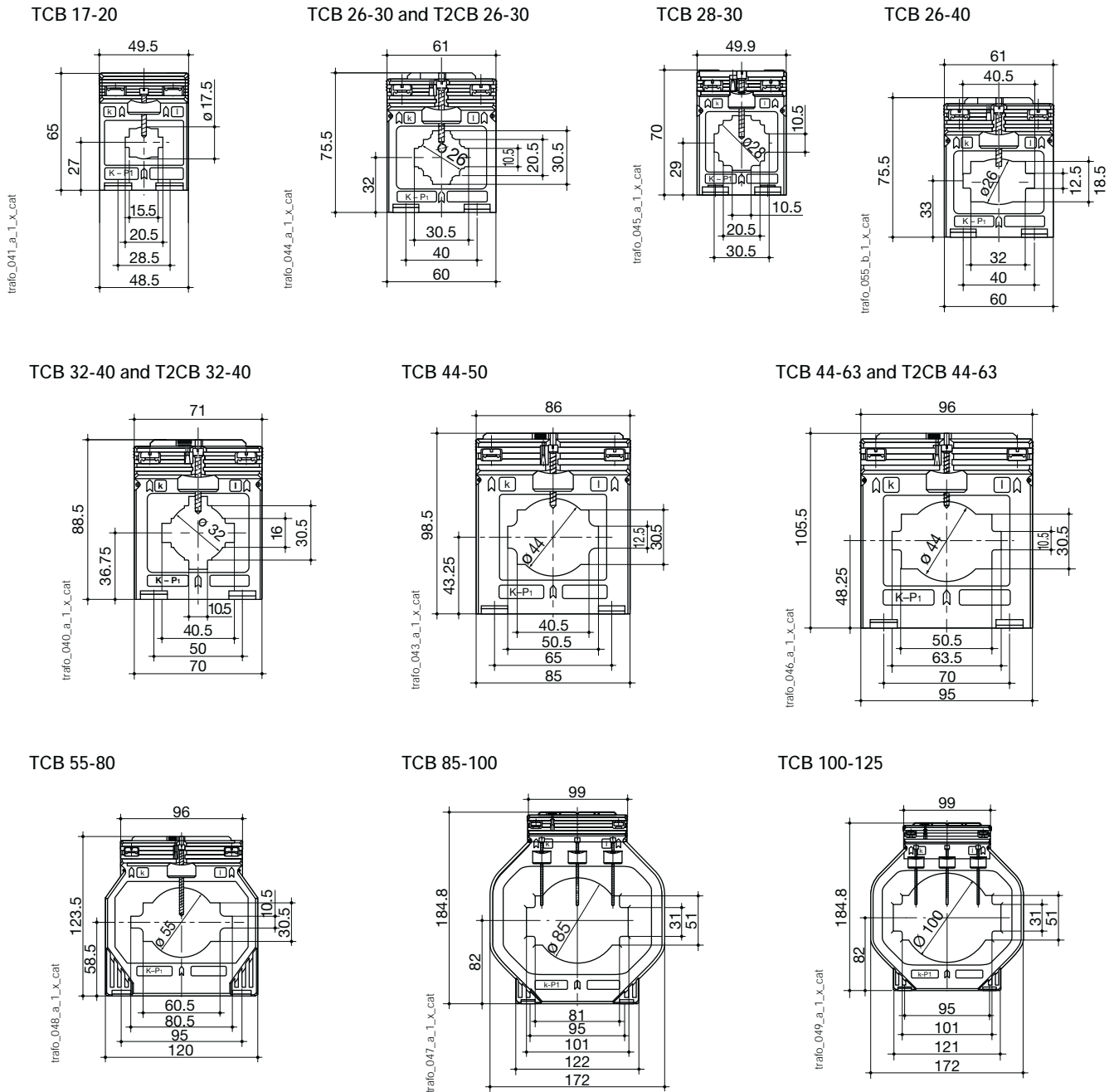

Bar or cable-through CT	TCB 17-20	TCB 26-30	T2CB 26-30	TCB 26-40	TCB 28-30	TCB 32-40	T2CB 32-40
Bar (mm)	20 x 5 (x 1)	30 x 10 (x 1) / 20 x 10 (x 1...2)	30 x 10 (x 1) / 20 x 10 (x 1...2)	40 x 12 (x 1) / 32 x 18 (x 1)	30 x 10 (x 1)	40 x 10 (x 1) / 30 x 5 (x 1...2)	40 x 10 (x 1) / 30 x 5 (x 1...2)
ϕ cable (mm)	17.5	26	26	26	28	32	32
H x W x D (mm)	65 x 49.5 x 50	75.5 x 61 x 48	75.5 x 61 x 48	75.5 x 61 x 48	70 x 49.9 x 68	88.5 x 71 x 58	88.5 x 71 x 58
DIN-rail mounting	yes	yes	yes	yes		yes	yes

Bar or cable-through CT	TCB 44-50	TCB 44-63	T2CB 44-63	TCB 55-80	TCB 85-100	TCB 100-125
Bar (mm)	50 x 12 (x 1) / 40 x 10 (x 1...2)	63 x 10 (x 1) / 50 x 10 (x 1...2)	63 x 10 (x 1) / 50 x 10 (x 1...2)	80 x 10 (x 1) / 60 x 30 (x 1) / 60 x 10 (x 1...2)	100 x 10 (x 1...2) / 80 x 10 (x 1...3)	123 x 30 (x 1) / 100 x 10 (x 1...3)
ϕ cable (mm)	44	44	44	55	85	100
H x W x D (mm)	98.5 x 86 x 58	105.5 x 96 x 58	105.5 x 96 x 58	123.5 x 120 x 58	184.5 x 172 x 52	184.5 x 172 x 52

Associated transducers



trafo_074

Transducer to be associated with adapted current transformers:

- Class 0.5.
- Input: 1 or 5 A
- Output:
 - 0-20 mA, 0-10 V (model CEA-VA),
 - 4-20 mA, 0-10 V (model CEA-VA4),
- Self-supplied or auxiliary power supply 24 VDC or 230 VAC.
- 3 sizes according to the CT: type 1, 2 or 3.

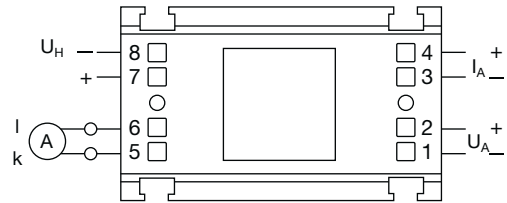

trafo_060_a_1_x_cat

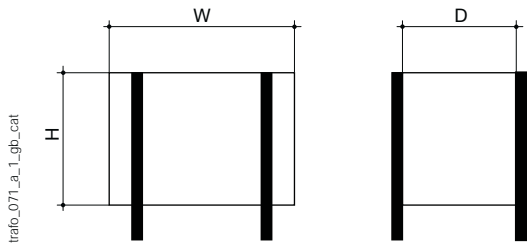

trafo_071_a_1_gb_cat

Dimensions (mm)

Converter	For CT	Height (mm)	Width (mm)	Depth (mm)
Type 1	TCB 26-30	50.5	60	32.5
Type 1	TCB 26-40	50.5	60	32.5
Type 2	TCB 32-40	50	70	43
Type 3	TCB 44-63	50.5	95	43
Type 3	TCB 55-80	50.5	95	43

Current transformers

Measurement devices

from 5 to 5000 A

Bar-through CT

References

Primary	Secondary	TBA 60			TBA 80		TBA 100		T2BA 100	
		Class 0.5	Class 1	Reference	Class 0.5	Reference	Class 0.5	Reference	Class 0.2s	Reference
200 A	5 A		2.5 VA	192T 7020						
250 A	5 A	2.5 VA		192T 7025						
300 A	5 A	2.5 VA		192T 7030	2.5 VA	192T 7530				
400 A	5 A	5 VA		192T 7040	5 VA	192T 7540				
500 A	5 A	5 VA		192T 7050	5 VA	192T 7550				
600 A	5 A	10 VA		192T 7060	5 VA	192T 7560	5 VA	192T 8060		
750 A	5 A	10 VA		192T 7075	5 VA	192T 7575	5 VA	192T 8075		
800 A	5 A	10 VA		192T 7080	10 VA	192T 7580	5 VA	192T 8080		
1000 A	5 A	15 VA		192T 7090	15 VA	192T 7590	5 VA	192T 8090		
1200 A	5 A	15 VA		192T 7092	15 VA	192T 7592	10 VA	192T 8092	5 VA	192U 8092
1250 A	5 A	15 VA		192T 7093	15 VA	192T 7593	10 VA	192T 8093	5 VA	192U 8093
1500 A	5 A	15 VA		192T 7095	15 VA	192T 7595	15 VA	192T 8095	5 VA	192U 8095
1600 A	5 A	15 VA		192T 7094	15 VA	192T 7594	15 VA	192T 8094		
2000 A	5 A				15 VA	192T 7596	15 VA	192T 8096	5 VA	192U 8096
2500 A	5 A						30 VA	192T 8097	10 VA	192U 8097
3000 A	5 A						30 VA	192T 8098 (1)	10 VA	192U 8098
4000 A	5 A						30 VA	192T 8099 (1)		

(1) Dimensions are different for TBA 100 with 3000 and 4000 A primary.

Primary	Secondary	TBA 103		T2BA 103		TBA 127		T2BA 127	
		Class 0.5	Reference	Class 0.2s	Reference	Class 0.5	Reference	Class 0.2s	Reference
400 A	5 A	2.5 VA	192T 9340			2.5 VA	192T 9740		
500 A	5 A	2.5 VA	192T 9350			2.5 VA	192T 9750		
600 A	5 A	2.5 VA	192T 9360			2.5 VA	192T 9760		
750 A	5 A	2.5 VA	192T 9375			2.5 VA	192T 9775		
800 A	5 A	5 VA	192T 9380			5 VA	192T 9780		
1000 A	5 A	10 VA	192T 9390	5 VA	192U 9390	10 VA	192T 9790		
1200 A	5 A	10 VA	192T 9392	5 VA	192U 9392	10 VA	192T 9792	5 VA	192U 9792
1250 A	5 A	10 VA	192T 9393	5 VA	192U 9393	10 VA	192T 9793	5 VA	192U 9793
1500 A	5 A	15 VA	192T 9395	5 VA	192U 9395	15 VA	192T 9795	5 VA	192U 9795
1600 A	5 A	10 VA	192T 9394			15 VA	192T 9794		
2000 A	5 A	15 VA	192T 9396			15 VA	192T 9796	5 VA	192U 9796
2500 A	5 A					15 VA	192T 9797		
3000 A	5 A					25 VA	182T 9798 (1)		
4000 A	5 A					30 VA	182T 9799 (1)		

(1) Replacement model TRA 127 for this rating.

Accessories

Description of accessories	TBA 60 Reference	TBA 80 Reference	TBA 100 Reference	T2BA 100 Reference	TBA 103 Reference	T2BA 103 Reference	TBA 127 Reference	T2BA 127 Reference
Sealable cover	192T 0102		192T 0102	192T 0102			192T 0102	192T 0102

CT Plug-in transducer (CEA-VA)

Power supply	Output	TBA 100 Reference
Self-supplied	0-20 mA / 0-10 VDC	192Y 0045
230 VAC	0-20 mA / 0-10 VDC	192Y 0245
24 VDC	0-20 mA / 0-10 VDC	192Y 0145

CT Plug-in transducer (CEA-VA4)

Power supply	Output	TBA 100 Reference
230 VAC	4-20 mA / 0-10 VDC	192Y 0285
24 VDC	4-20 mA / 0-10 VDC	192Y 0185

Dimensions (mm)

TBA 60

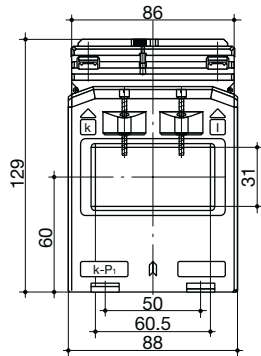

trafo_050_a_1_x_cat

TBA 80
300 to 2000 A

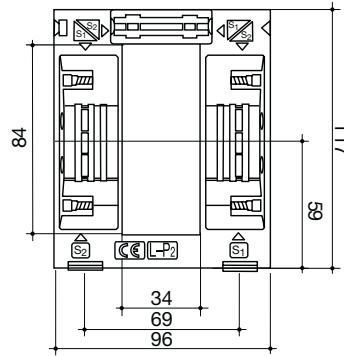

trafo_059_a_1_x_cat

TBA 100 600 to 2500 A⁽¹⁾
T2BA 100 1200 to 3000 A

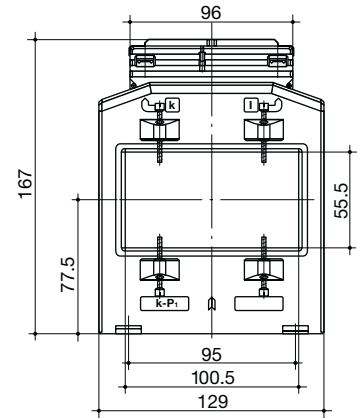

trafo_082_a_1_x_cat

(1) TBA 100, 3000 and 4000 A: 214 x 129 x 78 mm.

TBA 103 and T2BA 103

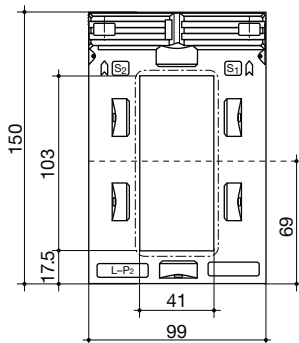

trafo_054_a_1_x_cat

TBA 127 and T2BA 127

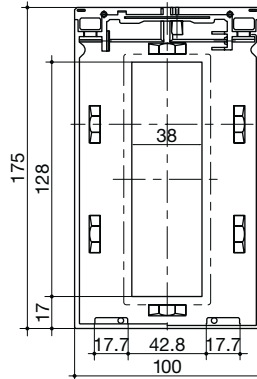

trafo_052_a_1_x_cat

Bar-through CT	TBA 60	TBA 80	TBA 100	T2BA 100	TBA 103	T2BA 103	TBA 127	T2BA 127
Bar (mm)	60 x 30	84 x 34	100 x 55	100 x 55	103 x 41	103 x 41	128 x 38	128 x 38
H x W x D (mm)	129 x 88 x 78	117 x 96 x 68	167 x 129 x 78 ⁽¹⁾	167 x 129 x 78	150 x 99 x 58	150 x 99 x 58	175 x 100 x 55	175 x 100 x 55

(1) TBA 100, 3000 and 4000 A: 214 x 129 x 78 mm.

Current transformers

Measurement devices

from 5 to 5000 A

Three-phase bar or cable-through CT

References

Primary	Secondary ⁽¹⁾	TCB3 18-20		TCB3 22-30	
		Class 1	Reference	Class 1	Reference
3 x 100 A	3 x 5 A	1 VA	192T 3310		
3 x 150 A	3 x 5 A	1.25 VA	192T 3315		
3 x 200 A	3 x 5 A	1.5 VA	192T 3320		
3 x 250 A	3 x 5 A	2.5 VA	192T 3325	2.5 VA	192T 3425
3 x 300 A	3 x 5 A			3.75 VA	192T 3430
3 x 400 A	3 x 5 A			5 VA	192T 3440
3 x 500 A	3 x 5 A			5 VA	192T 3450
3 x 600 A	3 x 5 A			5 VA	192T 3460

(1) Secondary 1 A: on request.

Dimensions (mm)

TCB3 18-20

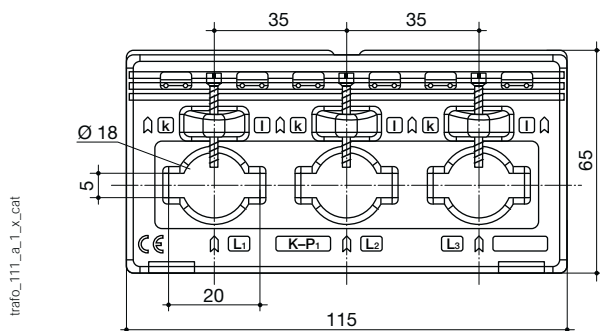

TCB3 22-30

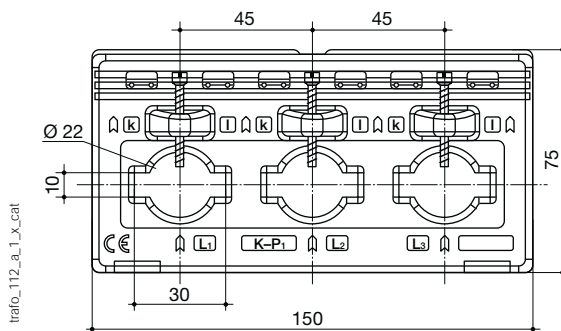

Three-phase bar or cable-through CT	TCB3 18-20	TCB3 22-30
Ø cable (mm)	18	22
Bar-through	20 x 5	30 x 10
H x W x D (mm)	115 x 65 x 37	150 x 75 x 37
DIN-rail mounting	no	no

References

Primary	Secondary ⁽¹⁾	TCA 13 — 3P	
		Class 1	Reference
3 x 50 A	5 A	1 VA	192T 1905
3 x 60 A	5 A	1.25 VA	192T 1906
3 x 75 A	5 A	1.5 VA	192T 1907
3 x 80 A	5 A	1.5 VA	192T 1908
3 x 100 A	5 A	2.5 VA	192T 1910
3 x 125 A	5 A	2.5 VA	192T 1912
3 x 150 A	5 A	2.5 VA	192T 1915
3 x 160 A	5 A	2.5 VA	192T 1916

(1) Secondary 1 A: on request.

Dimensions (mm)

TCA 13 — 3P

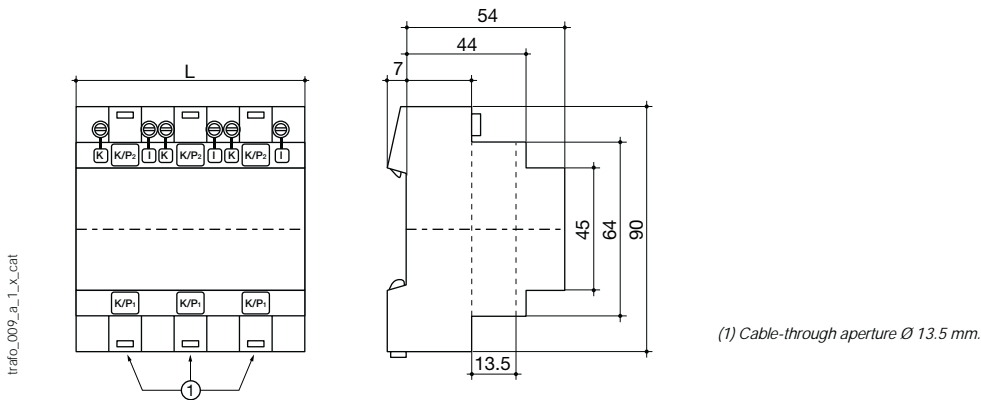

Number of modules	Front degree of protection	Terminal degree of protection	L (mm)	Mounting
6	IP65	IP20	105	35 mm DIN-rail

Current transformers

Measurement devices

from 5 to 5000 A

Split-core CT

References

Primary	Secondary	TO 23			TO 58			TO 812			TO 816	
		Class 1	Class 3	Reference	Class 0.5	Class 1	Reference	Class 0.5	Class 1	Reference	Class 0.5	Reference
100 A	5 A		1.25 VA	192T 4601								
150 A	5 A		1.5 VA	192T 4602								
200 A	5 A		2.5 VA	192T 4603								
250 A	5 A	1.5 VA		192T 4604		1.5 VA	192T 4625		1.5 VA	192T 4725		
300 A	5 A	3.75 VA		192T 4605		2.5 VA	192T 4630		2.5 VA	192T 4730		
400 A	5 A	5 VA		192T 4606	1 VA		192T 4640		2.5 VA	192T 4740		
500 A	5 A				2.5 VA		192T 4650	2.5 VA		192T 4750		
600 A	5 A				2.5 VA		192T 4660	2.5 VA		192T 4760		
750 A	5 A				2.5 VA		192T 4675	2.5 VA		192T 4775		
800 A	5 A				2.5 VA		192T 4680	2.5 VA		192T 4780		
1000 A	5 A				5 VA		192T 4610	5 VA		192T 4710	10 VA	192T 4810
1250 A	5 A							7.5 VA		192T 4712	10 VA	192T 4812
1500 A	5 A							7.5 VA		192T 4715	10 VA	192T 4815
1600 A	5 A										10 VA	192T 4814
2000 A	5 A										10 VA	192T 4820
2500 A	5 A										10 VA	192T 4825
3000 A	5 A										15 VA	192T 4830
4000 A	5 A										15 VA	192T 4840
5000 A	5 A										15 VA	192T 4850

Dimensions (mm)

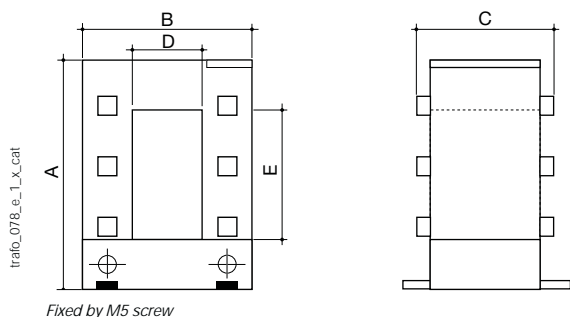

Dimensions (mm)

Type	A (mm)	B (mm)	C (mm)	D (mm)	E (mm)
TO 23	106	93	58	23	33
TO 58	158	125	58	55	85
TO 812	198	155	58	85	125
TO 816	243	195	79	85	165

Split-core CT	TO 23	TO 58	TO 812	TO 816
H x W x D (mm)	106 x 93 x 58	158 x 125 x 58	198 x 155 x 58	243 x 195 x 75

Summation CT

Reference

Primary	Secondary	BSA 02 Reference	BSA 03 Reference	BSA 04 Reference
5 + 5/5 A	5 A	192T 0802		
5A + 5+ 5/5	5 A		192T 0803	
5 + 5 + 5 + 5/5 A	5 A			192T 0904

Dimensions (mm)

BSA 02 and BSA 03

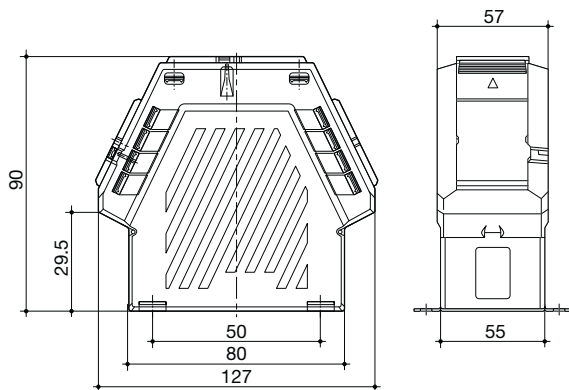

BSA 04

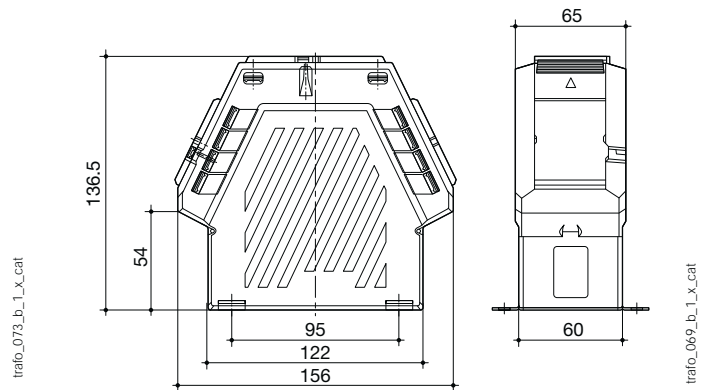

Summation CT	BSA 02	BSA 03	BSA 04
H x W x D (mm)	90 x 127 x 57	90 x 127 x 57	136.5 x 156 x 65
DIN-rail mounting	no	no	no



Measurement shunts

Measurement devices

Current transformers

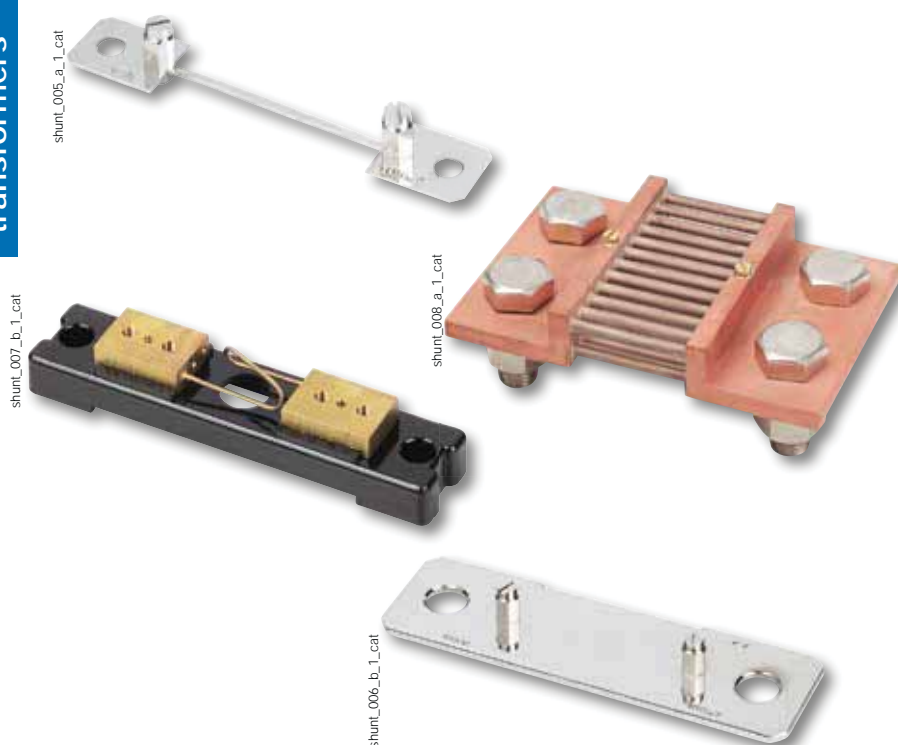

Composition of the range

- > 20 ratings available from 1 to 6000 A, with 100 mV output
- > Other ratings and secondary voltages are available. Please contact us

Function

SOCOMEc shunts provide indirect measurement of direct current by creating a standardised voltage drop.

Characteristics

- Voltage drop: 100 mV for nominal rating.
- Accuracy class: 0,5.
- Permanent overload: 1.2 In.
- 10 In / 5s rating \leq 500 A
5 In / 5s rating 600 to 1500 A
2 In / 5s rating \geq 2500 A.

References

Rating (A) ⁽¹⁾	Secondary voltage drop	DIN series Reference
1 A	100 mV	192S 2101
4 A	100 mV	192S 2104
6 A	100 mV	192S 2106
10 A	100 mV	192S 2110
15 A	100 mV	192S 2112
25 A	100 mV	192S 2114
40 A	100 mV	192S 2116
60 A	100 mV	192S 2118
100 A	100 mV	192S 2120
150 A	100 mV	192S 2125
200 A	100 mV	192S 2220
250 A	100 mV	192S 2235
300 A	100 mV	192S 2230
400 A	100 mV	192S 2240
600 A	100 mV	192S 2250
1000 A	100 mV	192S 2255
1500 A	100 mV	192S 2260
2500 A	100 mV	192S 2165
4000 A	100 mV	192S 2170
6000 A	100 mV	192S 2175

(1) Other rating: please consult us.

Dimensions

DIN Series 1 to 25 A

Fig. 1

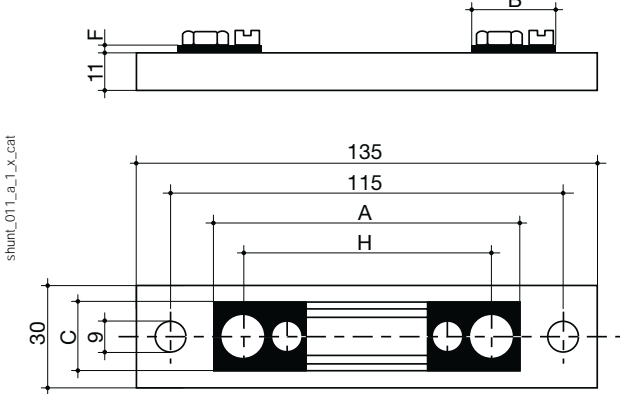

Rating (A) ⁽¹⁾	Figure	A	B	C	D	E	F	G	H	I
1	1	90	28	20			8		78	
4	1	90	28	20			8		78	
6	1	90	28	20			8		78	
10	1	90	28	20			8		78	
15	1	90	28	20			8		78	
25	1	90	28	20			8		78	
40	2	123	33	20			8		103	
60	2	123	33	20			8		103	
100	2	123	33	20			8		103	
150	2	123	33	20			8		103	
200	2	168	55	30	15		10	10	128	30
250	2	168	55	30	15		10	10	128	30
300	2	168	55	40	20		10	10	128	30
400	2	168	55	40	20		10	10	128	30
600	2	168	55	40	20		10	10	128	30
1000	2	188	65	60	30		10	10	138	30
1500	3	188	65	90	21	48	10	10	138	30
2500	3	188	65	120	30	60	10	10	138	30
4000	3	188	65	120	30	60	15	10	138	60
6000	3	188	65	180	30	60	15	10	138	60

(1) Connection: 2 M5 screws x 8 and 2 washers Ø 5.3 mm.

DIN Series 40 to 1000 A

Fig. 2

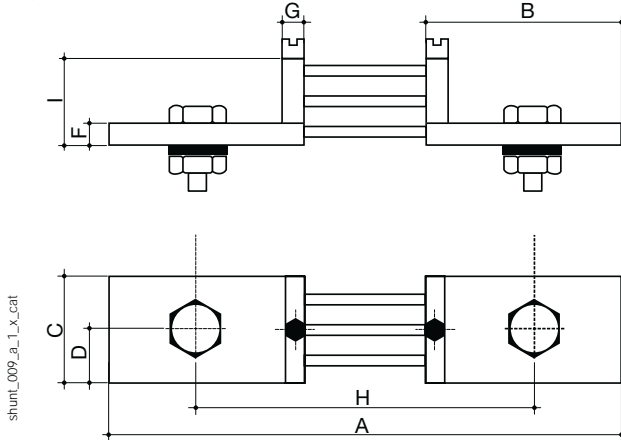

DIN Series 1500 to 6000 A

Fig. 3

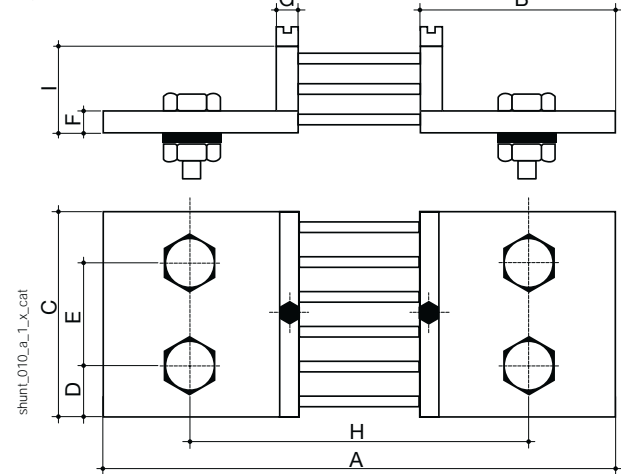



Other products

Measurement devices

Current transformers

PTI: CT automatic short-circuiter



Use

This device provides automatic short-circuiting of the CT: if the measuring circuit is opened.

Conformity to standards

- > NF C 15-100 articles 473.1.4-556.3
- > GAM EG 13.C (military standard)

Other regulations

- > Decree n° 88-1056 from 14-11-88: protection of workers
- > Complies with the Mines and Quarries decree n° 91-986

References

Rating (A)	Trigger voltages	Operating frequency	Max. differential voltage	Reference
5 A	21 VAC	45 ... 400 Hz	600 VAC	4990 0521
5 A	25 VAC	45 ... 400 Hz	600 VAC	4990 0525 ⁽¹⁾

⁽¹⁾ DCN approved (French State Naval Construction Company).

Characteristics

Case degree of protection	IP55
Terminal protection degree	IP20
Connection cross-section	2.5 mm ²
Weight	82 g

Rating (A)	D1	E	F	H	H1	I	L
5	4.2	47	9.6	32	44	41	34.7

Dimensions (mm)

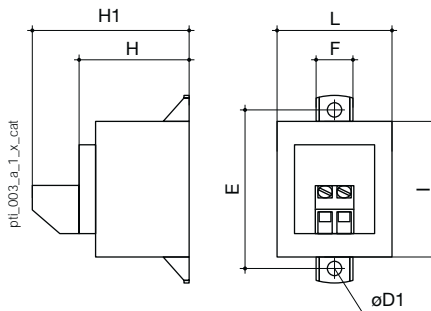

Sensor PT100 - screw type

- Element sensitivity as per standard IEC 751 class A.
- 4 wire mounting.
- 3 meter length output of Teflon isolated cable.
- Tolerance class A:
 - Accuracy at -50 °C: ± 0.14 °C,
 - Accuracy at 0 °C: ± 0.13 °C,
 - Accuracy at +50 °C: ± 0.25 °C,
 - Accuracy at +100 °C: ± 0.26 °C,
 - Accuracy at +150 °C: ± 0.33 °C.

References

Products	Reference
Temperature sensor PT100 - M6 screw type	4825 0208
Temperature sensor PT100 - eyelet type	4825 0209

Dimensions

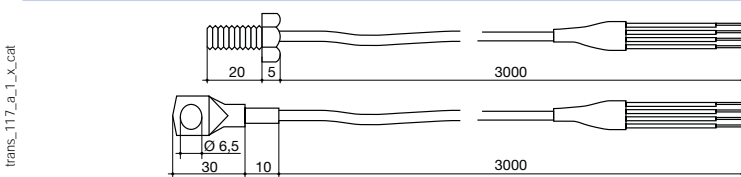

Transformer with integrated converter (CTA-VA)



Compact measurement converter with cable-through transformer (Ø27 mm) or bar transformer (40 x 10 mm).

- Input:
 - Direct Connection 0 to 10 A,
 - CT primary of 50 to 400 A (self-supplied)
 - CT primary of 15 to 500 A (auxiliary supply)

- Output:
 - 0-20 mA, 0-10 V (type CTA-VA)
 - 4-20 mA and 0-10 V (type CTA-VA4).
- Self-supplied or auxiliary power supply 24 VDC or 230 VAC.
- Dimension: 135 x 80 x 50 mm.

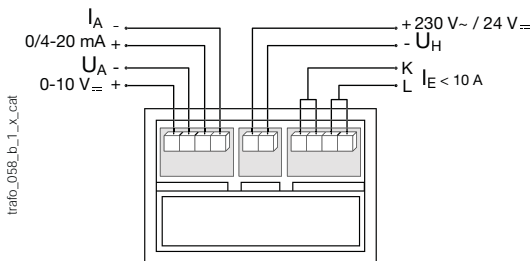

References

	0-20 mA / 0-10 VDC Self supplied	4-20 mA / 0-10 VDC 230 VAC	4-20 mA / 0-10 VDC 24 VDC
Primary	Reference	Reference	Reference
5 A	-	192Y 0602	192Y 0902
10 A	-	192Y 0603	-
15 A	-	192Y 0604	192Y 0904
20 A	-	192Y 0605	192Y 0905
25 A	-	192Y 0606	192Y 0906
30 A	-	192Y 0607	192Y 0907
40 A	-	192Y 0608	192Y 0908
50 A	192Y 0409	-	192Y 0909
60 A	192Y 0410	-	-
75 A	192Y 0411	192Y 0611	192Y 0911
100 A	192Y 0412	192Y 0612	192Y 0912
250 A	192Y 0425	-	192Y 0925
400 A	192Y 0440	-	192Y 0940
500 A	-	192Y 0650	-

Voltage transformer BTV 25



Applications

Measurement and conversion of the input value read at the primary of a transformer in a directly proportional voltage signal.

BTV 25 products are voltage transformers.

Recommendation

Voltage transformers are used specifically for supplying measurement equipment, therefore it is not recommended to connect other components which could affect accuracy. This is due to the effect of the phase shift error. If the consumption is greater than 25 VA, another transformer must be added.

Characteristics

Accuracy class	1 %
Dielectric quality	3 kV for 1 min.
Operating frequency	50 - 60 Hz
Permanent overload	1.2 U_n

Connection

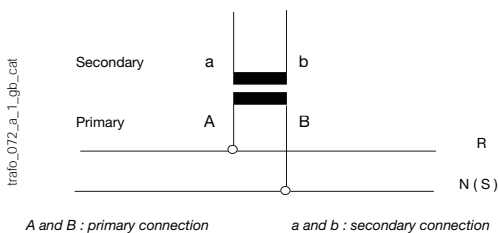

References

Primary	Secondary	Power	Reference
230 VAC	100 VAC	25 VA	192M 2020
400 VAC	100 VAC	25 VA	192M 2030
440 VAC	100 VAC	25 VA	192M 2044
500 VAC	100 VAC	25 VA	192M 2050
600 VAC	100 VAC	25 VA	192M 2060
660 VAC	100 VAC	25 VA	192M 2066
800 VAC	100 VAC	25 VA	Please consult us

Dimensions (mm)

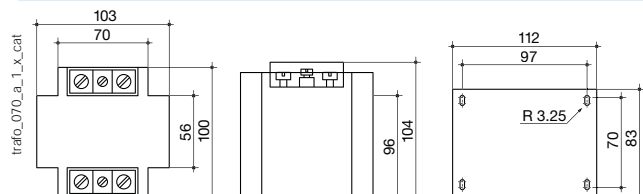



Other electrical measurement devices

Measurement devices

Transducers



They provide conversion of an AC electrical value (A, V, Hz, Cos phi, W, Var) into a DC signal, with standardised current or voltage.

They are available in surface-mount casings (CS range).

These devices are designed for DIN rail or back plate mounting.

Type CS transducers are available in two sizes:

- 75 mm for current, voltage and frequency converters,
- 150 mm for power or three-phase converters.

Consult us.

Modular transducers



Available in:

- 3-DIN module housings (52.5 mm) for current, voltage and frequency converters,
- 6-DIN module housings (105 mm) for current (output 4-20 mA), voltage (output 4-20 mA) converters,
- 9-DIN module housings (157.5 mm) for power or three-phase converters.

Consult us.

Analogue meters



SOCOMEK ferromagnetic ammeters and voltmeters measure the AC current/voltage of any electrical circuit. SOCOMEC vibrating reed or needle type frequency meters have a converter either integrated or in a separate casing and measure the frequency of any electrical circuit.

The wattmeters, varmeters and phase-meters consist of an analogue meter and a separate converter. They are available in 3 types of casing: Rotex round barrel model in 72 or 96, in a DIN 48 to 144 body or a modular casing (3 modules).

With pointer deflections of 90° and 240°, they can be flush-mounted into cubicles, enclosures or other equipment.

Consult us.

Selector switches



Voltmeter and ammeter switches that allow phase selection on a three-phase circuit for voltage and current measurement.

They are available in three different casings:

- for screw mounting,
- with a central \varnothing 22 mm mounting,
- for DIN rail mounting.

Consult us.

Digital meters



They measure all types of electrical values (A, V, Hz, Cos phi, P, Q...).

The range:

- 2 different types of casing: rectangular or square:
 - 2 sizes of rectangular casing,
 - 2 sizes of square casing.
- direct measurement or connection to a current or voltage transformer,
- 2000-point (3.5 digits) or 20000-point (4.5 digits) display,
- possibility of having 2 or 3 different types of measurement in the same square casing (AAA-VVV-AVF...),
- multi-indicator version,
- RMS-value.

Consult us.

Hour counters



Often combined with analogue meters in an electrical panel, hour counters count the total operating time of machines or electrical equipment.

Consult us.



DIRIS G

Wireless and cabled RS485 to Ethernet communication gateways

Communication interfaces



Configuration with EasyConfig.

Function

With communication gateways **DIRIS G** all the information from meters and power monitors, communicating by radio frequency or RS485, is centralized and made available on the Ethernet Modbus (TCP).

DIRIS G gateways can retrieve data from meters or Socomec remote measuring points via Ethernet.

The gateway has an embedded WEBVIEW web server, allowing real time monitoring of electrical values and analysis of consumption data. The user can be alerted of any alarms via email.

Advantages

WEBVIEW⁽¹⁾ embedded web server

DIRIS G gateways include an embedded web server. Two versions are available:

- Power Monitoring:
 - Realtime measurements and alerts.
- Power & Energy Monitoring:
 - Realtime measurements and alerts.
 - Trends for selected parameters and energy consumption history and analysis.

Scalable

Several optional modules are available:

- Digital inputs/outputs.
- Analogue inputs/outputs.
- Temperature inputs.

⁽¹⁾ See page "WEBVIEW" pages.

Plug & Play

- Connected metering and measurement devices are automatically addressed and detected by the DIRIS G gateway. These integrate the following:
 - Automatic time synchronisation (SNTP) with battery recording
 - Synchronisation of connected devices
 - Warning messages in the event of an alert (e-mail SMTP)
 - Automatic recording and storage of measurements and consumption data
 - Automatic tariff changes (multi-tariff).
- Data exported automatically via FTP server.

The solution for

- > Industry
- > Building
- > Infrastructure
- > Local authority



Strong points

- > WEBVIEW embedded web server
- > Scalable
- > Plug & Play

Compliance with standards

- > IEC 61010



- > ISO 14025



- > UL



Create your project

- > Find the best DIRIS Digiware configuration:
www.meter-selector.com



Selection guide

	Gateway	DIRIS G-30	DIRIS G-40	DIRIS G-50	DIRIS G-60
Communication	RS485 Modbus	•	•	•	•
	Radio frequency Communication (wireless)		•		•
	Ethernet	•	•	•	•
WEBVIEW embedded web server.	Power Monitoring	•	•	•	•
	Power & Energy Monitoring			•	•

Architecture

Example of communication architecture with DIRIS G gateway and WEBVIEW embedded WEB server

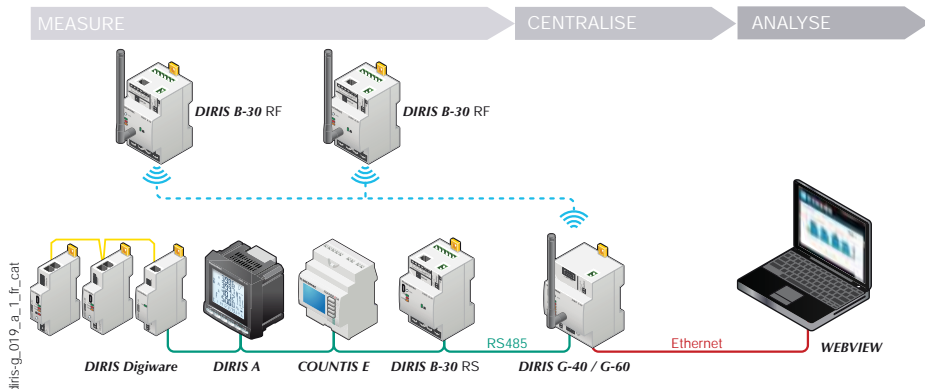

Embedded web server

WEBVIEW embedded web server

- Version Power Monitoring: embedded in DIRIS G-30 and G-40
- Version Power & Energy Monitoring: embedded in DIRIS G-50 and G-60
- 32 devices max (RS485 and wireless indifferently)



DIRIS O optional modules

A maximum of 4 optional modules can be connected to a DIRIS G gateway in order to integrate controls/ commands.

DIRIS O-iod	2 digital inputs / 2 digital outputs
DIRIS O-ioa	2 analogue inputs / 2 analogue outputs
DIRIS O-it	3 temperature inputs
DIRIS O-m	Additional slave RS485 communication



Accessories

Remote radio antenna

- Allows the antenna to be mounted outside the enclosure to increase the transmission distance up to 300 m if there are no obstacles.

USB configuration cable

- Configuration of DIRIS G gateways can be achieved using EASY CONFIG software via Ethernet or direct USB connection.

DIRIS G terminals

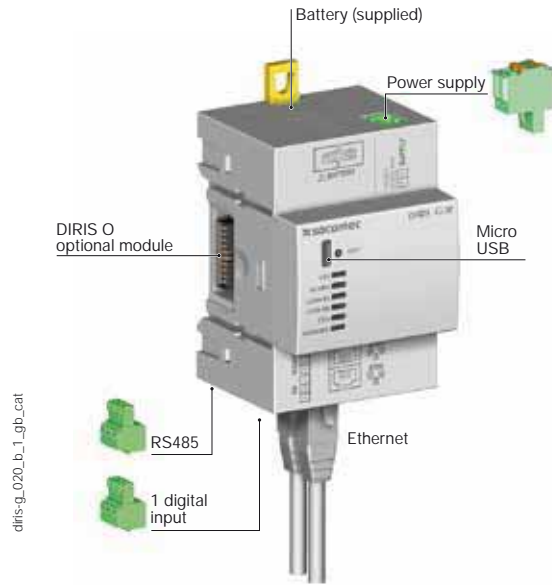

Power supply

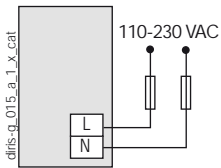

NC: not connected

Input powered by the product

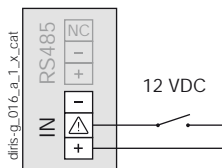

Input with external power supply

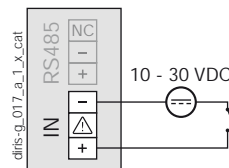

RS485

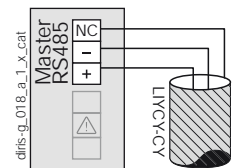

Terminals of DIRIS O optional modules

Optional modules are common to the DIRIS B-30 monitoring device. For a description of the terminals see "DIRIS B" pages.

Dimensions (mm)

DIRIS G-30 / G-40 / G-50 / G-60

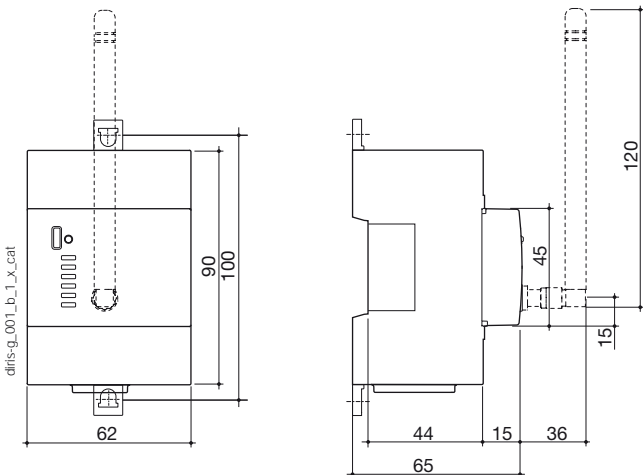

DIRIS O optional modules

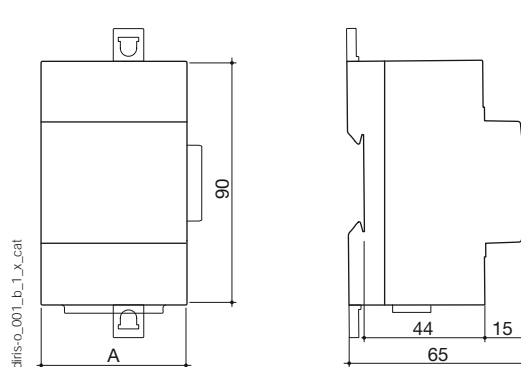

DIRIS O optional modules

DIRIS O-iod - DIRIS O-ioa - DIRIS O-it - DIRIS O-m

A
45 mm

Specifications

Mechanical specifications	
Casing type	DIN-rail mounting module and base
Case degree of protection	IP20 / IK06
Front degree of protection	IP40 on the nose in modular assembly / IK08
Weight	DIRIS G-30, G-50 = 190 g DIRIS G-40, G-60 = 215 g
Electrical characteristics	
Power supply	
Alternative voltage	110-230 VAC \pm 15% (Ph/N or Ph/Ph) Cat III
Frequency	50/60 Hz
Power consumption	6 VA
Battery	CR 1220 3 V lithium button cell battery
Input	
Number	1
Type / Power supply	Optocoupler internal polarisation (12 VDC \pm 10%) or external (10-30 VDC \pm 10%)
Input function	Logic status, pulse meter or synchronisation pulse status
Communication specifications	
DIRIS G	
Link	RS485
Connection type	2 ... 3 half duplex wires
Protocol	Modbus RTU
Baudrate	2400 ... 115200 bauds
Function	Communication with PMDs and meters
DIRIS G-40 and DIRIS G-60	
Link	Radio-frequency (RF)
Frequency range	868 MHz (low frequency: 868.1 MHz and high: 869.5875 MHz)
Baudrate	38400 bauds
Function	Communication with DIRIS B-30 RF
Scope	300 m (open field)
Ethernet	
Link	Ethernet 10/100 base-T, 2 RJ45 bases with integrated switch
Protocol	Modbus TCP (port 502), Modbus RTU over TCP (port 503), HTTP, SMTP, SNTP, DHCP, FTP (G-50/G-60)
Clock	Internal
SNTP protocol	Gateway time updating from an NTP server. Connected PMDs time updating.
SMTP protocol	Sending of alarm emails from the gateway
Function	Configuration of the gateway, connected PMDs and meters Access to the WEBVIEW web server, data centralisation
USB	
Connection type	USB 2 (required installation of Easy Config)
Protocol	Modbus RTU on USB
Function	Configuration of the gateway, connected PMDs and meters
Connection	Type B micro USB connector
Memory characteristics	
Consumption history (memory extension for meters and measurement units)	1 year (1 hour period)
Electrical values	2 months (10 min period)
Number of events	Alarms 1000 Network quality according to EN 50160: 1000
Environmental specifications	
Ambient operating temperature	-10 ... +70°C
Storage temperature	-25 ... +85°C
Operating humidity	55°C / 97% HR

References

DIRIS G gateways		Reference
DIRIS G-30	RS485 / Ethernet - WEBVIEW Power Monitoring	4829 0300
DIRIS G-40	RS485-RF / Ethernet - WEBVIEW Power Monitoring	4829 0301
DIRIS G-50	RS485 / Ethernet - WEBVIEW Power & Energy Monitoring	4829 0302
DIRIS G-60	RS485-RF / Ethernet - WEBVIEW Power & Energy Monitoring	4829 0303
DIRIS O optional modules		Reference
DIRIS O-iod	2 digital inputs / 2 digital outputs	4829 0030
DIRIS O-ioa	2x 4-20 mA analogue inputs / 2x 4-20 mA analogue outputs	4829 0031
DIRIS O-it	3 temperature inputs, PT100/PT1000	4829 0032
DIRIS O-m	RS485 modbus slave communication	4829 0033
Accessories		To be ordered in multiples of
Wireless remote antenna, 868 MHz - 210 mm height		Reference
Cable for remote antenna - SMA connector - 3 meter length		4854 0126
USB configuration cable		4854 0127
Fuse holders to protect the auxiliary power supply (type RM) 1 pole + neutral		4829 0050
gG 10x38 0.5 A fuses		6 5601 0017
		10 6012 0000



Datalogger



The solution for

- > Industry
- > Building
- > Infrastructure
- > Local authority



Strong points

- > Easy to install
- > Reliable collection and transmission
- > Advanced functions

Expert Services

- > Study, definition, advice, commissioning, maintenance and training... Our experts "Expert Services" offer complete support for the success of your project.

Function

DATALOG H60 and H80 dataloggers associated with Socomec wireless interfaces enable you to create a smart energy data communication network in order to:

- Remotely and automatically read multi-fluid energy meters and multi-function meters, isolated or not.
- Pool, secure, store and provide the data to a computer application.
- Connect your meters and multi-function measurement units in a 2G/3G/GPRS network.

Advantages

Easy to install

- Quick installation on DIN rail or door mounting.
- Compact.
- Remote configuration.
- Configuration services (SOCOMECE services).

Reliable collection and transmission

- Configurable collection frequency for each energy and multi-function meter.
- Secure, regular transmission (daily, weekly, etc.).
- Multiple communication protocols (Modbus RTU/TCP, Wireless M-Bus, HTTP(s), FTP(s)).
- Collection interfaces: Ethernet - RS232/485 or Wireless.
- Transmission interface: Ethernet or 2G/3G/GPRS.

Advanced functions

- Extended data storage capacity (1 year for index data and 2 months for load curves).
- Auto-detects meters and measuring equipment.
- Sends regular activity reports.
- Event alerts (communication errors, data quality, remote server connection).

The SOCOMEC communicating energy-efficiency solution

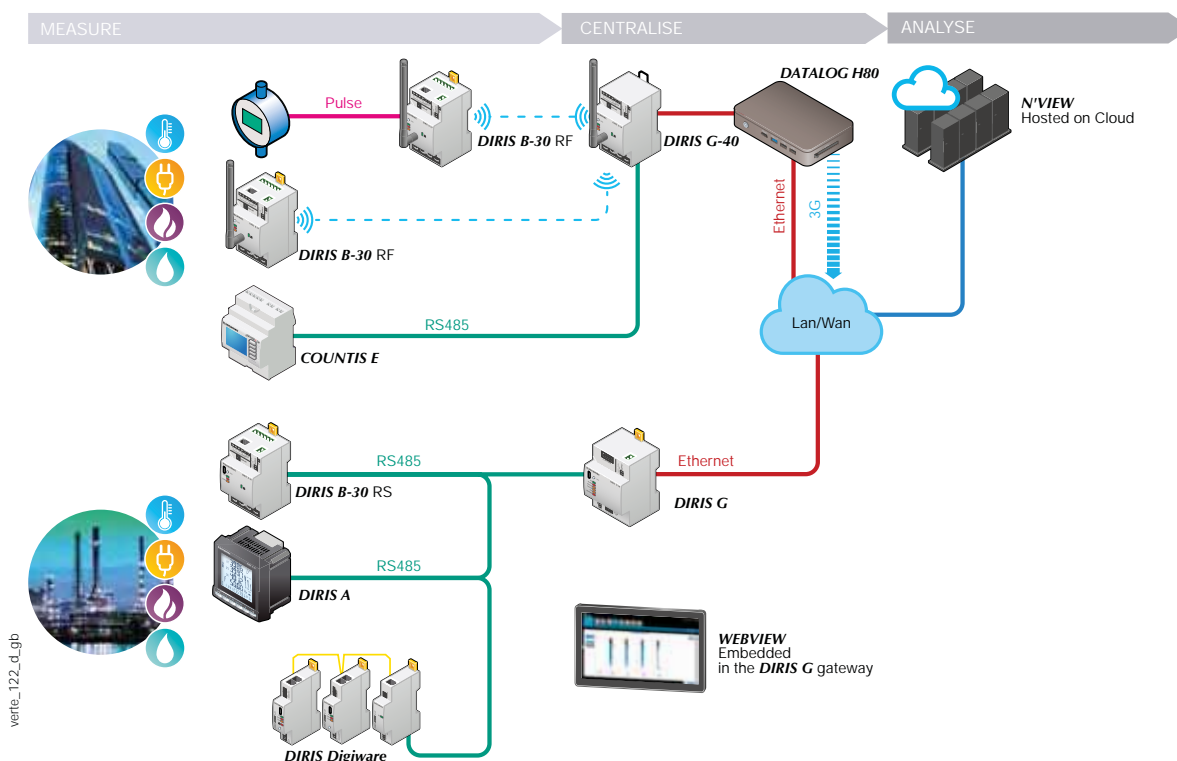

Specifications

	DATALOG H60	DATALOG H80/H81
Input/output interfaces		
Input	3 digital or pulse inputs	
Output	1 digital output (relay)	
Serial interfaces		
Input	1 port (Modbus)	
Output	1 port (Modbus or M-Bus)	
Wireless interface		
Wireless M-Bus	868.3 - 868.95 MHz	
Network interface		
Ethernet	1 10/100 Mb port	2 10/100/1000 Mb port
GSM/GPRS	850/900/1800/1900 MHz	
3G	900/2100 MHz	900/2100 MHz
Protocols		
Data collection	Modbus RTU and TCP/Wireless Mbus	Ethernet/Modbus TCP:
Data transmission	FTP	FTPS/HTTPS
Configuration		
Local	Yes	Yes
Distant	by text message	by FTP

References

Datalogger	Reference
DATALOG H60 (power supply included)	4854 0001
DATALOG H80 (without 3G connection)	4854 0010
DATALOG H81 (with 3G connection)	4854 0011
DATALOG H60 accessory description	Reference
5 m remote antenna extension	4854 0105
10 m remote antenna extension	4854 0110
20 m remote antenna extension	4854 0120



Wireless communication interfaces



The solution for

- > Industry
- > Building
- > Infrastructure
- > Local authority



Strong points

Wireless M-Bus Modem

- > Battery life
- > Ease of installation
- > Long range
- > 2 pulse inputs
- > Transmitter
- > Repeater
- > Receiver

ARF868 wireless modem

- > Sensitivity, transmission/reception quality
- > Ease of installation
- > Long range
- > Several types of communication

Expert Services

- > Study, definition, advice, implementation, maintenance and training... Our experts "Expert Services" offer complete support for the success of your project.

Function

Wireless M-Bus Modem

Wireless M-Bus AMR (Automatic Meter Reading) plug-and-play modems automatically collect energy data from water and gas meters. They autonomously read data (index) from water and gas meters. 100% compatible with the Wireless M-Bus standard (EN13757-3 and EN13757-4), device open protocols ensure full interoperability with other Wireless M-Bus products on the market.

Advantages

Wireless M-Bus Modem

Battery life

- Runs on battery for up to 12 years.

Ease of installation

- Factory pre-programmed.
- Quick installation.
- Robust IP65.

Long range

- Up to 1 km. Range can be increased by installing repeaters.

2 pulse inputs

- A single transmitter can handle two meters.
- Compatible with all water and gas meters.

Transmitter

- Wireless transmission of metering data (consumption) every 10 minutes (10s or 12hrs optional).

Repeater

- Wireless M-Bus wireless relay of metering data (consumption).
- Multiple repeaters can be used to extend the range.

Receiver

- Wireless M-Bus metering data (consumption) wireless receiver.
- RS485, RS232 or USB serial port.
- Remote antenna.

ARF868 wireless modem

ARF868 wireless modems convert data from a serial link into a wireless frame to send to a similar device in the frequency range 863-870 MHz. The power and sensitivity allow the data to be transmitted over distances of up to 20 km.

ARF868 wireless modem

Sensitivity, transmission/reception quality

- Power 25 mW or 500 mW at 868 MHz.
- Licence-free frequencies on European bands (863 - 870 MHz) or frequencies subject to license (410 - 470 MHz).

Ease of installation

- Quick installation.
- User-friendly and configuration with intuitive software.
- The product can be configured as a transmitter, receiver or repeater.

Long range

- 1 to 20 km.

Several types of communication

- RS485, RS232 or USB serial port.

Accessories

- 1-, 3- and 5-metre remote antenna.
- Antenna mount & adaptor.
- Power supply unit + connector (required).
- TNC converter pack.
- Sub D9 connector.
- IP53 and IP67 ingress protection rating.

Specifications

	Modem ARF868 (transmitter/repeater/ receiver model)	Wireless M-Bus transmitter modem: Water/Gas	Wireless M-Bus transmitter modem: Temperature	Wireless M-Bus repeater modem	Wireless M-Bus receiver modem
Scope	Up to 1/4/7/20 km according to model	Up to 1000 m	Up to 1000 m	Up to 1000 m	
Wireless frequencies	863-870 MHz	863-870 MHz	863-870 MHz	863-870 MHz	863-870 MHz
Interfaces					
Inputs	-	2 pulse inputs	2 temperature inputs: - 1 pre-equipped input - 1 free input	-	-
Communication	RS232 - RS485 - USB optional	-	-	-	RS232 - RS485 - USB
Alerts	-	Leak detection - Fraud detection - Battery spent	-	-	-
Storage capability	-	Index bufferisation (consumption history)	-	-	-
Compatibility	-	Sappel Izar, Itron Cyble, Itron Gallus 2000, Elster BK	-	-	-
General characteristics					
Dimensions W x H x D	135 x 75 x 35 mm	210 x 103.1 x 37.2 mm	210 x 103.1 x 37.2 mm	210 x 103.1 x 37.2 mm	210 x 103.1 x 37.2 mm
Operating temperature	-30 ... +70°C	-40 ... +85°C	-40 ... +85°C	-40 ... +85°C	-40 ... +85°C
Power supply	4.5 ... 36 V	3.6V Li-SOCl2 battery. Battery life up to 12 years guaranteed	3.6V Li-SOCl2 battery. Battery life up to 12 years guaranteed	3.6 V. Power supply block supplied, model with battery optional	4.5 ... 36 VDC
Protection degree	IP53, IP67 (optional)	IP65	IP53	IP65	IP65
Standards	EN300-220 V2010/EN301-489/EN 60950				

References

Wireless M-Bus modem

	Reference
Wireless M-Bus Modem - Water	4854 0054
Wireless M-Bus Modem - Gas	4854 0055
Wireless M-Bus Modem - Temperature	4854 0056
Wireless M-Bus receiver modem – RS232	4854 0057
Wireless M-Bus receiver modem – RS485	4854 0058
Wireless M-Bus receiver modem – USB	4854 0059
Wireless M-Bus repeater modem	4854 0060

ARF868 wireless modem

	Reference
Modbus wireless modem, distance 20 km	4854 0050
Modbus wireless modem, distance 7 km	4854 0051
Modbus wireless modem, distance 4 km	4854 0052
Modbus wireless modem, distance 1 km	4854 0053
List of accessories for ARF868 wireless modem	
	Reference
Power supply (mandatory)	4854 0202
RS232/USB cable (mandatory to configure ARF868 wireless modems)	4854 0400
RS485 connector (mandatory for use with RS485)	4700 9993
0.5 dB remote antenna + 1 m extension	4854 0121
0.1 dB remote antenna + 3 m extension	4854 0122
1.5 dB remote antenna + 5 m extension	4854 0123
Wall bracket for remote antenna	4854 0124
IP53 protection	4854 0300
IP67 protection	4854 0301



Communication accessories

Connecting the RS485 link

USB / RS485 interface

inter_002_a_2_cat



Function

If the PC is not equipped with a serial port, this interface can be connected via a USB port to obtain an RS485 communication port. Recommended for local use and not for permanent installation.

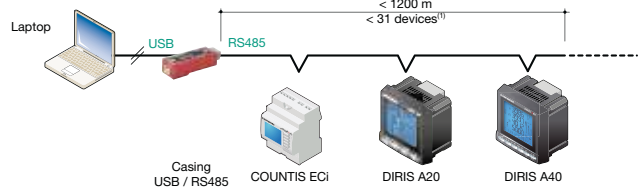

inter_142_g_1_gb_cat

(1) Beyond these characteristics, use an "RS422 / RS485 repeater".

References

Description of accessories	Reference
External USB / RS485 interface unit	4899 0110

RS422 / RS485 repeater

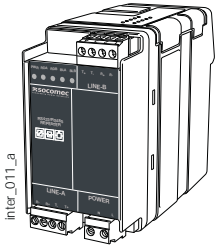

Function

In some applications the maximum distance and/or the maximum number of devices can be exceeded. One solution to this technical restriction is to install an interface which amplifies the signal over a further 1200 m (at 9600 bauds) for 31 devices.

In addition, it allows you to introduce a new branch to the network, thereby making it possible to reduce the length of connection cable required by avoiding back and forth cabling.

References

Auxiliary power supply U_s	Frequency	Reference
95 ... 240 VAC / 110 ... 250 VDC	50 Hz	4899 0120

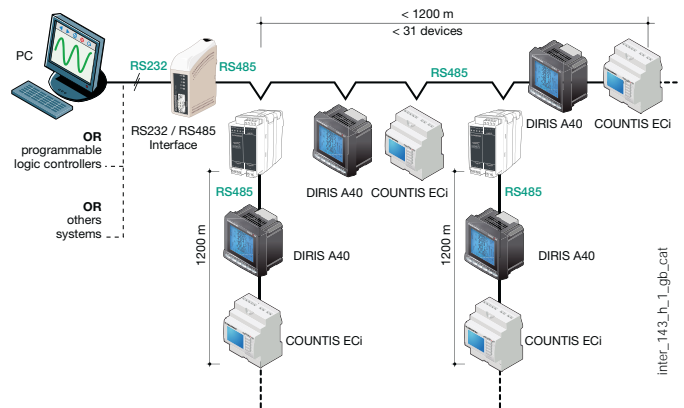

Other solutions and services

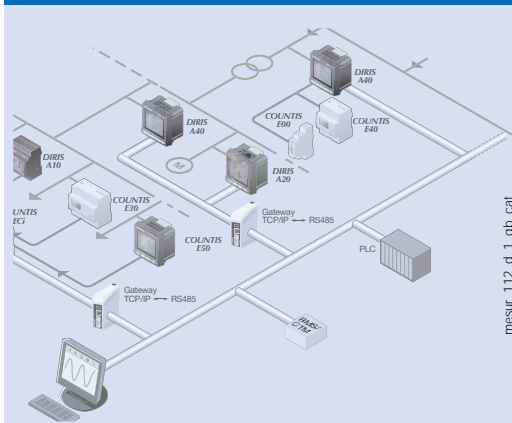

The accessories listed in these pages represent a selection from our range. We can supply many other solutions upon request, such as SHDSL interfaces, fibre optics/RS485, GSM/GPRS and protocol converter interfaces.

Need something integrating into your network?

No problem for our Expert Services team. They will fully integrate all your SOCOMEC devices, audit your system, commission selected equipment and train your staff on its use.

For further information, please contact your nearest SOCOMEC branch.



WEBVIEW

Monitoring software for energy measurement and analysis

Software suite



soft_027_a_1_fr_cat

The solution for

- > Industry
- > Building
- > Infrastructure
- > Local authority



Function

WEBVIEW is a web based software embedded in DIRIS A-40 meters and in communication gateways (DIRIS G, DIRIS Digiware D-70, DATALOG H80/H81) delivering real-time monitoring of all measurements from up to 200 devices and displaying the breakdown of energy consumptions.

Uncover the causes of electrical disturbances and anticipate maintenance requirements thanks to historical records of multiple electrical parameters.

Pre-set alarms defined by the user can be sent by e-mail. Users can access WEBVIEW via a web browser on a PC or a tablet.

Strong points

- > Plug & Play
- > Easy to use
- > Various functions

Compliance with standards

- > IEC 62974-1⁽¹⁾



(1) Energy Server standard applicable to WEBVIEW-M and L versions hosted on DIRIS G, DIRIS Digiware D-70 and DATALOG H80.

Advantages

Plug & Play

Quickly configure WEBVIEW thanks to the automatic detection of Socomec devices. Create geographical and electrical hierarchies to reflect your installation and your processes.

Easy to use

WEBVIEW centralises all the device measurements via a single clear and user friendly interface. The ergonomics of the display screens allow users to easily and quickly analyse the parameters and the behaviour of the installation.

Various functions

Very easy to configure and to use, WEBVIEW offers a wide range of features including real-time monitoring, alarm management and transmission by e-mail, multi-utility analysis (electricity, water, gas), power parameter logging and allocation of consumption by end-use and location.

Characteristics

Type	Hosting	Functions	Number of measurement devices
WEBVIEW-S	DIRIS A-40	Monitor, Alarm, View	1
WEBVIEW-M	DIRIS G-30/G-40	Monitor, View	32
	DIRIS G-50/G-60	Monitor, Alarm, View,	32
	DIRIS Digiware D-70	Monitor, Alarm, View, Photoview	32
WEBVIEW-L	DATALOG H80/H81	Monitor, Alarm, View, Photoview	100/200

Functions

Monitor

- Automatic detection of connected devices.
- Summary of the parameters measured for the electrical network and loads.
- Display of voltage, current, power, power factor, total harmonic distortion (THD) and harmonics per rank.
- Display of average/instantaneous values with min/max limits depending on the devices.
- Total and partial energy consumption per load.
- Input/output status.
- Synchronisation of device clocks.
- Graphical or table representation.

Alarm

- Alarms for overloads, events and input status changes.
- Display of alarms history.
- Sorting by type, nature, criticality or state.
- Alarms displayed on the main page.
- Transmission of alarms by e-mail (SMTP).

View

- Historical measurements and consumption.
- Historical records of multiple power parameters.
- Distribution of consumption by location, by end-use and by utility (water, gas, electricity...).
- Export of consumption data in a CSV format.

Photoview

- Photoview: customised dashboard of the WEBVIEW environment via the upload of graphical files (building plans, electrical circuit diagrams, production processes...)
- Real time data tracking via the insertion of parameters on the background pictures (measurement points, alarms, text...).
- Display of the mapping of the measurement plan by cascading of several images.



References

Type	Host device	Reference
WEBVIEW-S	DIRIS A-40	4825 0501
WEBVIEW-M	DIRIS Digiware D-70	4829 0202
	DIRIS G-30	4829 0300
	DIRIS G-40	4829 0301
	DIRIS G-50	4829 0302
	DIRIS G-60	4829 0303
WEBVIEW-L 100	DATALOG H80	4854 0020
	DATALOG H81 (3G network)	4854 0021
WEBVIEW-L 200	DATALOG H80	4854 0030
	DATALOG H81 (3G network)	4854 0031



N'VIEW

Online service to manage your energy performance

Software suite



soft_043_a_1_x_cat

The solution for

- > Industry
- > Building
- > Infrastructure
- > Local authority



Strong points

- > Easy to use
- > Multi-user access
- > Various functions

Function

The N'VIEW online service offers easy and intuitive analysis of energy consumption regardless of the business sector (industry, building, infrastructure...).

Compatible with the main market communication gateways including Socomec devices (DIRIS G, DIRIS Digiware D-70 and DATALOG H80/81), N'VIEW platform ensures that multi-utility data is collected.

From the identification of potential energy savings to long-term performance tracking and investment validation, N'VIEW offers a complete package of services for efficient energy management.

To meet specific requirements, the N'VIEW platform can also interface with other energy management applications (Energy Apps) which are already available or can be created on demand.

Advantages

Easy to use

Cloud-based hosting on a scalable and secure platform ensures the project is easily implemented, and offers great flexibility with an N'VIEW subscription.

Eliminates technical infrastructure problems, leaving the customer free to focus on management of energy performance.

Multi-user access

The N'VIEW service appeals to stakeholders directly involved in energy performance, such as Energy Managers and technical users. It also provides services to help the management team define the energy strategy, and to help management controllers optimise and allocate energy spending.

Various functions

The N'VIEW service provides a wide range of functions for the monitoring of measurements, the analysis of energy consumption levels and the management of costs.

All these features are part of a continuous improvement plan for energy performance, as defined in standard ISO 50001.

Functions

View

- Display of all data collected.
- Configuration of multiple viewing options (widgets) appropriate to the data displayed.
- Customisation of dashboards by user and by site.
- Graphical representation of the energy data (electrical hierarchy, site map or building map, industrial process diagram...).
- Comparison and ranking of sites based on their energy performance.



Analyse

- Analysis and comparison of multi-utility energy consumption according to multiple criteria (time frames, sites, fluids).
- Analyse energy costs.
- Tariff simulation and comparison.
- Management of external influencing factors (temperature, surface area, occupancy rate, production).
- Set up indicators for measuring energy efficiency.
- Measurement and verification based on the international method, IPMVP (International Performance Measurement and Verification Protocol).
- Forecasting of consumption levels and costs.
- Manage and archive customisable queries.



Alert and communicate

- Generation of personalised reports.
- Programming of multiple alarms (quality of data, cost overruns, consumption overruns).
- Manage and log alerts.
- Sending reports and alarms by e-mail (and by SMS for alarms).





Management software tools

Software suite



Easy Config software



Analysis software

Compatible with:



COUNTIS E



DIRIS A



DIRIS Digiware



DIRIS B

Function

To get the most effective use from your Socomtec measurement and metering devices, we can provide dedicated software tools:

Easy Config software

The Easy Config software enables quick and easy remote device configuration for DIRIS Digiware, DIRIS B, DIRIS G, COUNTIS E and DIRIS A devices. Configuration files can be copied from and sent to these devices, or they can be created without communication and sent at a later time.

Multiple devices can be configured from a single file which is especially useful for OEMs and panel builders, saving time when having to program many devices with the same configuration.

Analysis software

On the basis of an event log and the displayed curves, the Analysis software allows the analysis and extraction of quality data, as well as fault current monitoring (Residual Current Monitoring).

Principle diagram

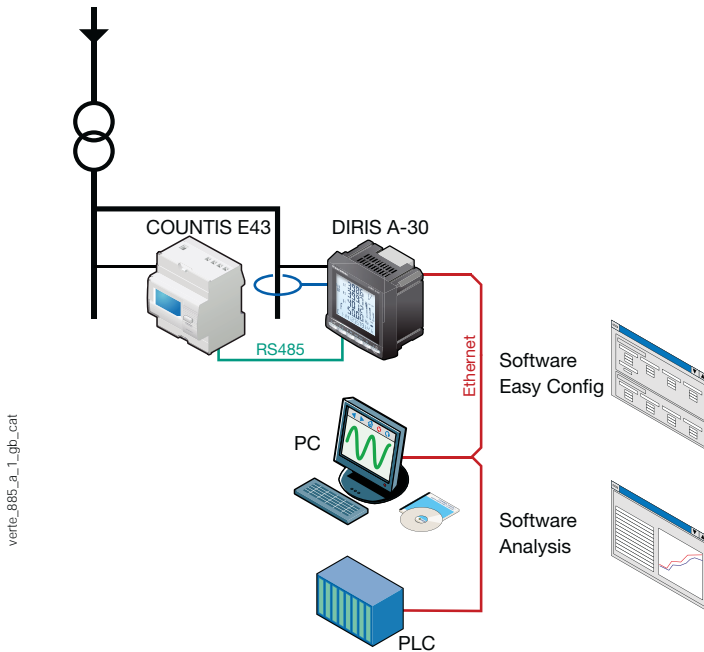

verte_885_a_1_gb_cat

	Easy Config	Analysis	WEBVIEW See page 136
COUNTIS E with RS485 communication	•		• ⁽¹⁾
COUNTIS Eci	•		• ⁽¹⁾
DIRIS A10, A14, A17 and A20 with RS485 communication	•		• ⁽¹⁾
DIRIS A-30 with RS485 communication	•		• ⁽¹⁾
DIRIS A-30 with Ethernet communication module	•		• ⁽¹⁾
DIRIS A-40	•		• ⁽¹⁾
DIRIS A60 with RS485 communication module	•	•	• ⁽¹⁾
DIRIS A60 with Ethernet communication module	•	•	• ⁽¹⁾
DIRIS B	•		• ⁽¹⁾
DIRIS Digiware	•		•
DIRIS G	•		•

(1) With DIRIS G or DIRIS Digiware D-70.

Management software tools

Easy Config software



The Easy Config software enables quick and easy remote configuration of DIRIS Digiware, DIRIS B, DIRIS G, COUNTIS E and DIRIS A devices.

It offers the following functions:

- Creating the configuration of devices prior to their connection (configuration template).
- Saving a configuration to a PC.
- Loading the configuration to devices through USB, RS485 or Ethernet.
- Retrieving the configuration of a device through USB, RS485 or Ethernet for saving, copying or modification purposes.

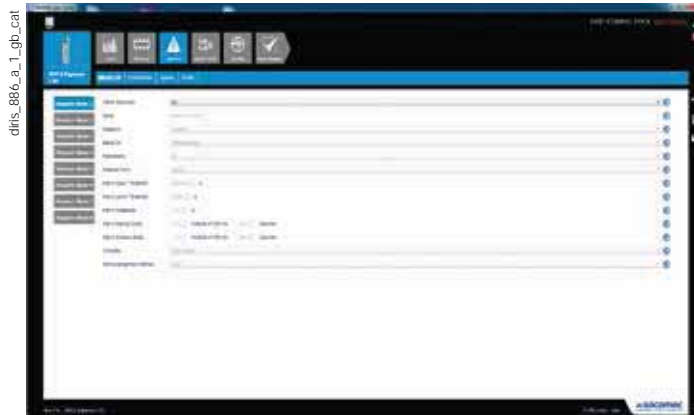

Configuration of loads

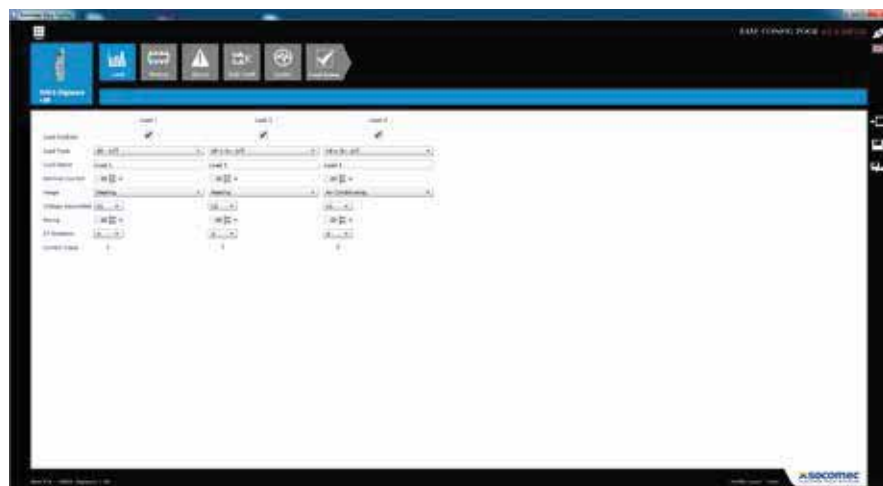

Configuration of Quality events

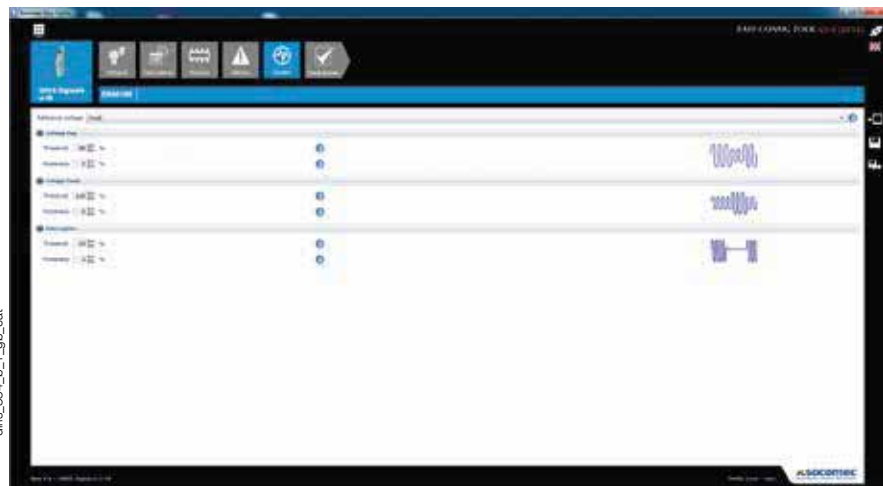

Analysis software

Improvement to the reliability of your electrical installation can be achieved with this software through the analysis of displayed event curves generated from the event log.

It offers the following functions:

- A list of voltage dips, cut-offs, overvoltages and overcurrents.
- A list of alarms $I\Delta n$ and I_{PE} for DIRIS A80.
- A display of 10 curves (3V, 3U, 3I, In) linked to the event with a zoom functionality.
- The classification of events according to the EN 50160 standard.
- Exporting of pictures or curve files.

This software can be connected to the DIRIS using either an RS485 MODBUS or Ethernet communication module.

The Analysis software can be downloaded from the SOCOMEC website: www.socomec.com

Event log



Event display and analysis

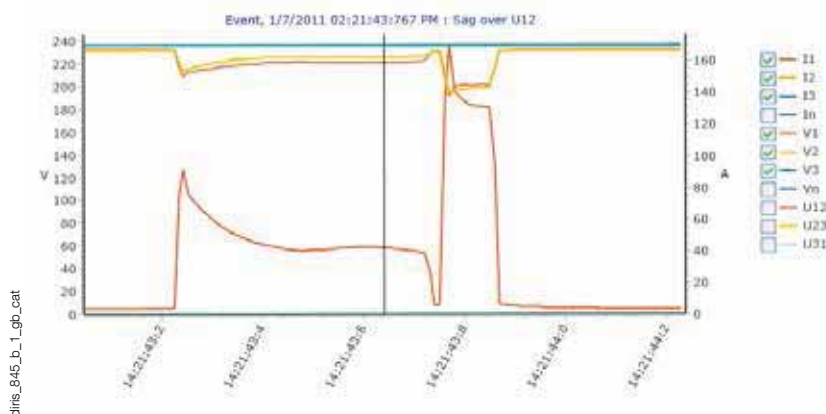

References list

References	Pages	References	Pages	References	Pages	References	Pages
18xx xxxx	134	192Y 0185	131, 134	4829 0129	45	4850 302x	119
192J 8015	125	192Y 0215	127, 130	4829 013x	45	4850 303x	113
192J 9120	75	192Y 0225	127	4829 014x	67	4850 3040	113
192M xxxx	143	192Y 0235	130	4829 0150	57	4850 3041	113
192S xxxx	140	192Y 0245	131, 134	4829 0151	57	4850 3042	113
192T 0003	127, 129, 130	192Y 0265	127	4829 0153	57	4850 3043	115
192T 0005	127, 130	192Y 0275	130	4829 0154	57	4850 3044	115
192T 0006	129	192Y 0285	131, 134	4829 0155	57	4850 3045	115
192T 0007	129, 130	192Y 04xx	143	4829 0156	61	4850 3046	115
192T 002x	129	192Y 06xx	143	4829 0157	61	4850 3047	115
192T 0101	127	192Y 09xx	143	4829 016x	41	4850 3048	115
192T 0102	131, 134	4700 9993	153	4829 0180	35, 37, 41, 45, 57, 61, 67	4850 3049	117
192T 0103	127, 130	4729 0603	35	4829 0181	35, 37, 41, 45, 57, 61, 67	4850 3050	117
192T 0105	127, 129, 130	4825 002x	83	4829 0182	35, 37, 41, 45, 57, 61, 67	4850 3051	117
192T 0106	131	4825 0080	75, 87	4829 0183	35, 37, 41, 45, 57, 61, 67	4850 3052	117
192T 0255	127, 130	4825 0082	75, 87	4829 0184	35, 37, 41, 45, 57, 61, 67	4850 3053	117
192T 05xx	127	4825 0083	75, 87	4829 0185	35, 37, 41, 45, 57, 61, 67	4850 3054	117
192T 06xx	127	4825 0088	75, 87, 93, 103	4829 0186	35, 37, 41, 45, 57, 61, 67	4850 3055	117
192T 08xx	139	4825 0089	75, 87, 93, 103	4829 0187	35, 37, 41, 45, 57, 61, 67	4850 3056	121
192T 09xx	139	4825 0090	93, 103	4829 0188	35, 37, 41, 45, 57, 61, 67	4850 3057	121
192T 14xx	129	4825 0092	93, 103	4829 0189	35, 37, 41, 57, 61	4850 3058	113
192T 19xx	137	4825 0093	93, 103	4829 0195	41	4850 3059	113
192T 20xx	129	4825 0094	93, 103	4829 0196	41	4850 3060	115
192T 21xx	130	4825 0097	93	4829 0199	35	4850 3061	115
192T 23xx	130	4825 0203	93, 103	4829 0200	35, 111	4850 3062	117
192T 24xx	130	4825 0204	93, 103	4829 0202	157	4850 3063	121
192T 32xx	130	4825 0206	93, 103	4829 0203	35	4850 3064	121
192T 33xx	136	4825 0207	103	4829 0204	35	4850 3065	121
192T 34xx	136	4825 0208	93, 103, 142	4829 028x	111	4850 3066	121
192T 40xx	130	4825 0209	93, 103, 142	4829 03xx	149, 157	4850 3067	121
192T 46xx	138	4825 0400	79	4829 050x	49	4850 3068	121
192T 47xx	138	4825 0401	79	4829 055x	51	4853 xxxx	125
192T 48xx	138	4825 0402	87	4829 057x	53	4854 000x	151
192T 5xxx	131	4825 0403	93	4829 058x	49, 51, 53	4854 001x	151
192T 6xxx	131	4825 0404	93	4829 0590	49, 51, 53	4854 002x	157
192T 7xxx	134	4825 0405	93	4829 0591	49, 51, 53	4854 003x	157
192T 80xx	134	4825 0406	93	4829 0592	49, 51, 53	4854 005x	153
192T 81xx	131	4825 0500	97	4829 0593	49, 51, 53	4854 006x	153
192T 93xx	134	4825 0501	97, 157	4829 0594	49, 51, 53	4854 010x	151
192T 95xx	131	4825 0502	97	4829 0595	49, 51, 53	4854 011x	151
192T 96xx	131	4826 0100	69	4829 0596	49, 51, 53	4854 0120	151
192T 97xx	134	4829 000x	111	4829 0597	49, 51, 53	4854 0121	153
192U 0xxx	127	4829 001x	111	4829 0598	49	4854 0122	153
192U 22xx	129	4829 0030	111, 149	4829 0599	49	4854 0123	153
192U 23xx	130	4829 0031	111, 149	4829 0600	49	4854 0124	153
192U 4xxx	130	4829 0032	111, 149	4829 0601	49, 51, 53	4854 0126	111, 149
192U 6xxx	131	4829 0033	111, 149	4829 0602	49, 51, 53	4854 0127	111, 149
192U 8xxx	134	4829 0034	111	4829 0603	49, 51, 53	4854 02xx	153
192U 9xxx	134	4829 0035	111	4829 0605	45	4854 03xx	153
192Y 0015	127, 130	4829 0036	111	4829 065x	51	4854 04xx	153
192Y 0025	127	4829 004x	111	4829 0670	53	4899 0011	75, 87, 93, 103
192Y 0035	130	4829 0050	35, 37, 41, 45, 57, 61, 67, 111, 149	4829 070x	65	4899 0110	154
192Y 0045	131, 134	4829 0101	35	4829 071x	65	4899 0120	155
192Y 0115	127, 130	4829 0102	37	4829 075x	65	49xx xxxx	142
192Y 0125	127	4829 0103	35	4829 078x	61, 65	5601 0017	75, 87, 103, 149
192Y 0135	130	4829 0105	37	4850 300x	119	5601 0018	75, 87, 103
192Y 0145	131, 134	4829 0106	37	4850 3010	123	5701 0017	35, 79, 93
192Y 0155	127, 130	4829 011x	45	4850 3011	123	5701 0018	37, 79, 93
192Y 0165	127	4829 0120	35	4850 3012	119	6012 0000	35, 37, 75, 79, 87, 93, 103, 149
192Y 0175	130	4829 0128	45	4850 3013	119		

Model: SOCOMEC
Production: SOCOMEC
Photography: Martin Bernhart and Studio Objectif
Printing:

Socomec: our innovations supporting your energy performance

1 independent manufacturer

3,600 employees worldwide

10 % of sales revenue dedicated to R&D

400 experts dedicated to service provision

Your power management expert



POWER SWITCHING



POWER MONITORING



POWER CONVERSION



ENERGY STORAGE



EXPERT SERVICES

The specialist for critical applications

- Control, command of LV facilities
- Safety of persons and assets
- Measurement of electrical parameters
- Energy management
- Energy quality
- Energy availability
- Energy storage
- Prevention and repairs
- Measurement and analysis
- Optimisation
- Consultancy, commissioning and training

A worldwide presence

12 production sites

- France (x3)
- Italy (x2)
- Tunisia
- India
- China (x2)
- USA (x3)

28 subsidiaries and commercial locations

- Algeria • Australia • Belgium • China • Canada
- Dubai (United Arab Emirates) • France • Germany
- India • Indonesia • Italy • Ivory Coast • Netherlands
- Poland • Portugal • Romania • Singapore • Slovenia
- South Africa • Spain • Switzerland • Thailand
- Tunisia • Turkey • UK • USA

80 countries

where our brand is distributed

HEAD OFFICE

SOCOMECC GROUP

SAS SOCOMECC capital 10 633 100 €
R.C.S. Strasbourg B 548 500 149
B.P. 60010 - 1, rue de Westhouse
F-67235 Benfeld Cedex
Tel. +33 3 88 57 41 41 - Fax +33 3 88 57 78 78
info.scp.isd@socomecc.com

YOUR DISTRIBUTOR / PARTNER

www.socomecc.com

